



This is a digital copy of a book that was preserved for generations on library shelves before it was carefully scanned by Google as part of a project to make the world's books discoverable online.

It has survived long enough for the copyright to expire and the book to enter the public domain. A public domain book is one that was never subject to copyright or whose legal copyright term has expired. Whether a book is in the public domain may vary country to country. Public domain books are our gateways to the past, representing a wealth of history, culture and knowledge that's often difficult to discover.

Marks, notations and other marginalia present in the original volume will appear in this file - a reminder of this book's long journey from the publisher to a library and finally to you.

Usage guidelines

Google is proud to partner with libraries to digitize public domain materials and make them widely accessible. Public domain books belong to the public and we are merely their custodians. Nevertheless, this work is expensive, so in order to keep providing this resource, we have taken steps to prevent abuse by commercial parties, including placing technical restrictions on automated querying.

We also ask that you:

- + *Make non-commercial use of the files* We designed Google Book Search for use by individuals, and we request that you use these files for personal, non-commercial purposes.
- + *Refrain from automated querying* Do not send automated queries of any sort to Google's system: If you are conducting research on machine translation, optical character recognition or other areas where access to a large amount of text is helpful, please contact us. We encourage the use of public domain materials for these purposes and may be able to help.
- + *Maintain attribution* The Google "watermark" you see on each file is essential for informing people about this project and helping them find additional materials through Google Book Search. Please do not remove it.
- + *Keep it legal* Whatever your use, remember that you are responsible for ensuring that what you are doing is legal. Do not assume that just because we believe a book is in the public domain for users in the United States, that the work is also in the public domain for users in other countries. Whether a book is still in copyright varies from country to country, and we can't offer guidance on whether any specific use of any specific book is allowed. Please do not assume that a book's appearance in Google Book Search means it can be used in any manner anywhere in the world. Copyright infringement liability can be quite severe.

About Google Book Search

Google's mission is to organize the world's information and to make it universally accessible and useful. Google Book Search helps readers discover the world's books while helping authors and publishers reach new audiences. You can search through the full text of this book on the web at <http://books.google.com/>



A propos de ce livre

Ceci est une copie numérique d'un ouvrage conservé depuis des générations dans les rayonnages d'une bibliothèque avant d'être numérisé avec précaution par Google dans le cadre d'un projet visant à permettre aux internautes de découvrir l'ensemble du patrimoine littéraire mondial en ligne.

Ce livre étant relativement ancien, il n'est plus protégé par la loi sur les droits d'auteur et appartient à présent au domaine public. L'expression "appartenir au domaine public" signifie que le livre en question n'a jamais été soumis aux droits d'auteur ou que ses droits légaux sont arrivés à expiration. Les conditions requises pour qu'un livre tombe dans le domaine public peuvent varier d'un pays à l'autre. Les livres libres de droit sont autant de liens avec le passé. Ils sont les témoins de la richesse de notre histoire, de notre patrimoine culturel et de la connaissance humaine et sont trop souvent difficilement accessibles au public.

Les notes de bas de page et autres annotations en marge du texte présentes dans le volume original sont reprises dans ce fichier, comme un souvenir du long chemin parcouru par l'ouvrage depuis la maison d'édition en passant par la bibliothèque pour finalement se retrouver entre vos mains.

Consignes d'utilisation

Google est fier de travailler en partenariat avec des bibliothèques à la numérisation des ouvrages appartenant au domaine public et de les rendre ainsi accessibles à tous. Ces livres sont en effet la propriété de tous et de toutes et nous sommes tout simplement les gardiens de ce patrimoine. Il s'agit toutefois d'un projet coûteux. Par conséquent et en vue de poursuivre la diffusion de ces ressources inépuisables, nous avons pris les dispositions nécessaires afin de prévenir les éventuels abus auxquels pourraient se livrer des sites marchands tiers, notamment en instaurant des contraintes techniques relatives aux requêtes automatisées.

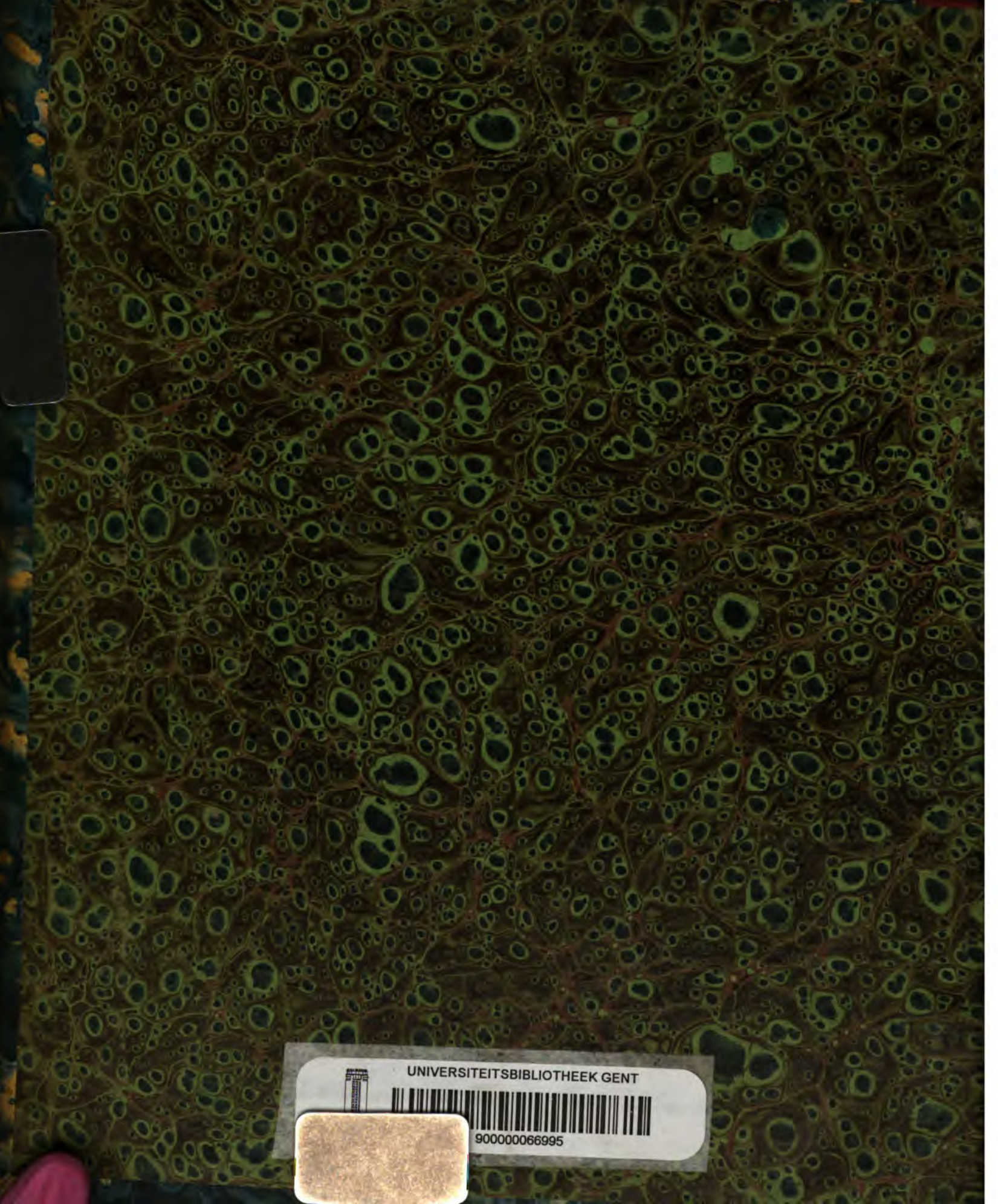
Nous vous demandons également de:

- + *Ne pas utiliser les fichiers à des fins commerciales* Nous avons conçu le programme Google Recherche de Livres à l'usage des particuliers. Nous vous demandons donc d'utiliser uniquement ces fichiers à des fins personnelles. Ils ne sauraient en effet être employés dans un quelconque but commercial.
- + *Ne pas procéder à des requêtes automatisées* N'envoyez aucune requête automatisée quelle qu'elle soit au système Google. Si vous effectuez des recherches concernant les logiciels de traduction, la reconnaissance optique de caractères ou tout autre domaine nécessitant de disposer d'importantes quantités de texte, n'hésitez pas à nous contacter. Nous encourageons pour la réalisation de ce type de travaux l'utilisation des ouvrages et documents appartenant au domaine public et serions heureux de vous être utile.
- + *Ne pas supprimer l'attribution* Le filigrane Google contenu dans chaque fichier est indispensable pour informer les internautes de notre projet et leur permettre d'accéder à davantage de documents par l'intermédiaire du Programme Google Recherche de Livres. Ne le supprimez en aucun cas.
- + *Rester dans la légalité* Quelle que soit l'utilisation que vous comptez faire des fichiers, n'oubliez pas qu'il est de votre responsabilité de veiller à respecter la loi. Si un ouvrage appartient au domaine public américain, n'en déduisez pas pour autant qu'il en va de même dans les autres pays. La durée légale des droits d'auteur d'un livre varie d'un pays à l'autre. Nous ne sommes donc pas en mesure de répertorier les ouvrages dont l'utilisation est autorisée et ceux dont elle ne l'est pas. Ne croyez pas que le simple fait d'afficher un livre sur Google Recherche de Livres signifie que celui-ci peut être utilisé de quelque façon que ce soit dans le monde entier. La condamnation à laquelle vous vous exposeriez en cas de violation des droits d'auteur peut être sévère.

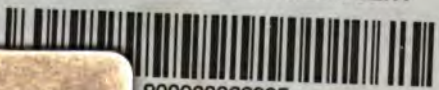
À propos du service Google Recherche de Livres

En favorisant la recherche et l'accès à un nombre croissant de livres disponibles dans de nombreuses langues, dont le français, Google souhaite contribuer à promouvoir la diversité culturelle grâce à Google Recherche de Livres. En effet, le Programme Google Recherche de Livres permet aux internautes de découvrir le patrimoine littéraire mondial, tout en aidant les auteurs et les éditeurs à élargir leur public. Vous pouvez effectuer des recherches en ligne dans le texte intégral de cet ouvrage à l'adresse <http://books.google.com>



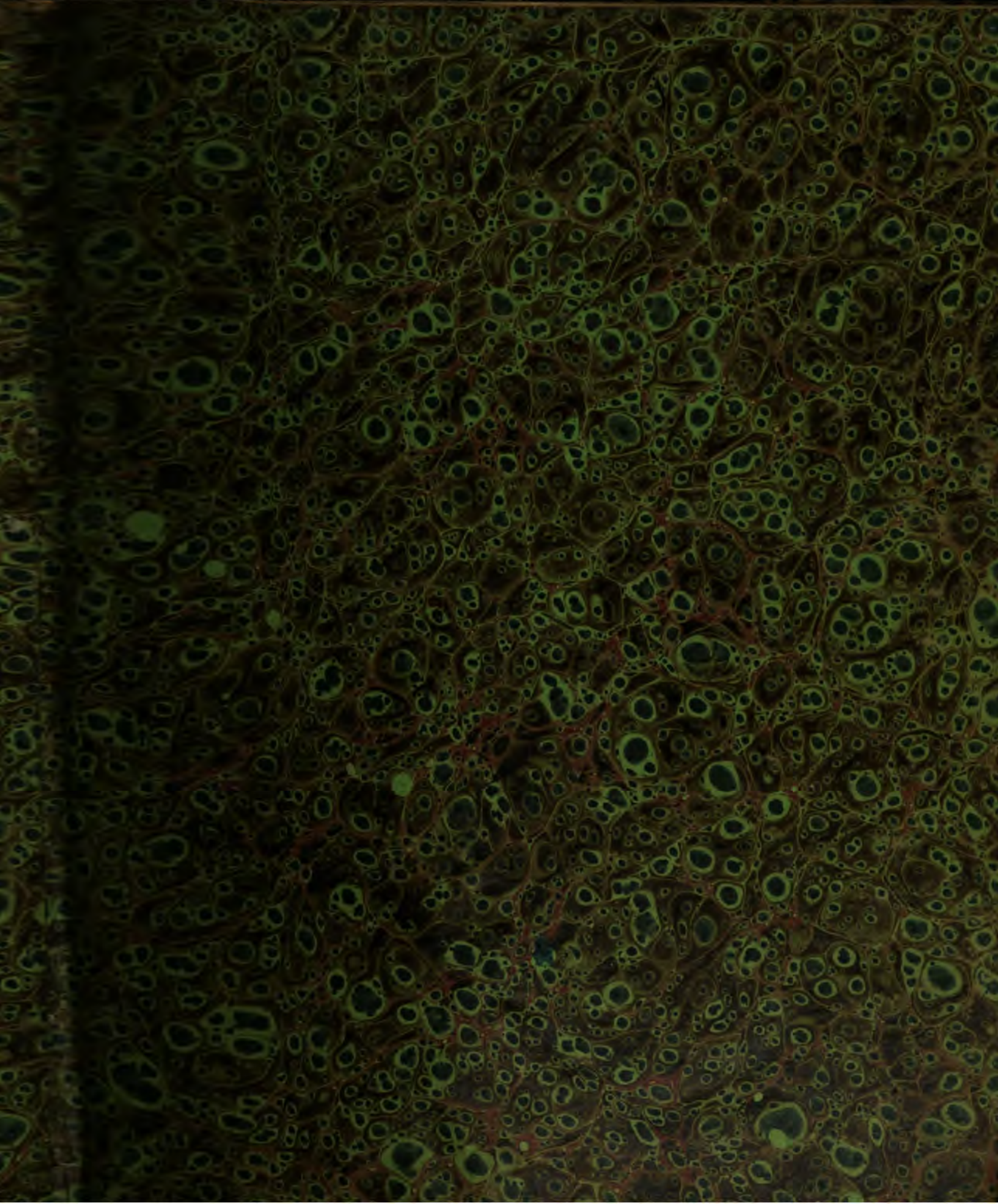


UNIVERSITEITSBIBLIOTHEEK GENT



900000066995





~~Math.~~
~~1474 a~~

Math. 453

Math. 453





TRAITÉ
DE LA CHALEUR

CONSIDÉRÉE

DANS SES APPLICATIONS

TRAITÉ DE LA CHALEUR

CONSIDÉRÉE
DANS SES APPLICATIONS

PAR E. PÉCLET

INSPECTEUR GÉNÉRAL DE L'UNIVERSITÉ, PROFESSEUR DE PHYSIQUE APPLIQUÉE AUX ARTS, A L'ÉCOLE CENTRALE
MEMBRE DE LA SOCIÉTÉ PHILOMATHIQUE, DU CONSEIL DE LA SOCIÉTÉ D'ENCOURAGEMENT, ETC

DEUXIÈME ÉDITION

ENTIÈREMENT REPOUNDUE

PLANCHES.

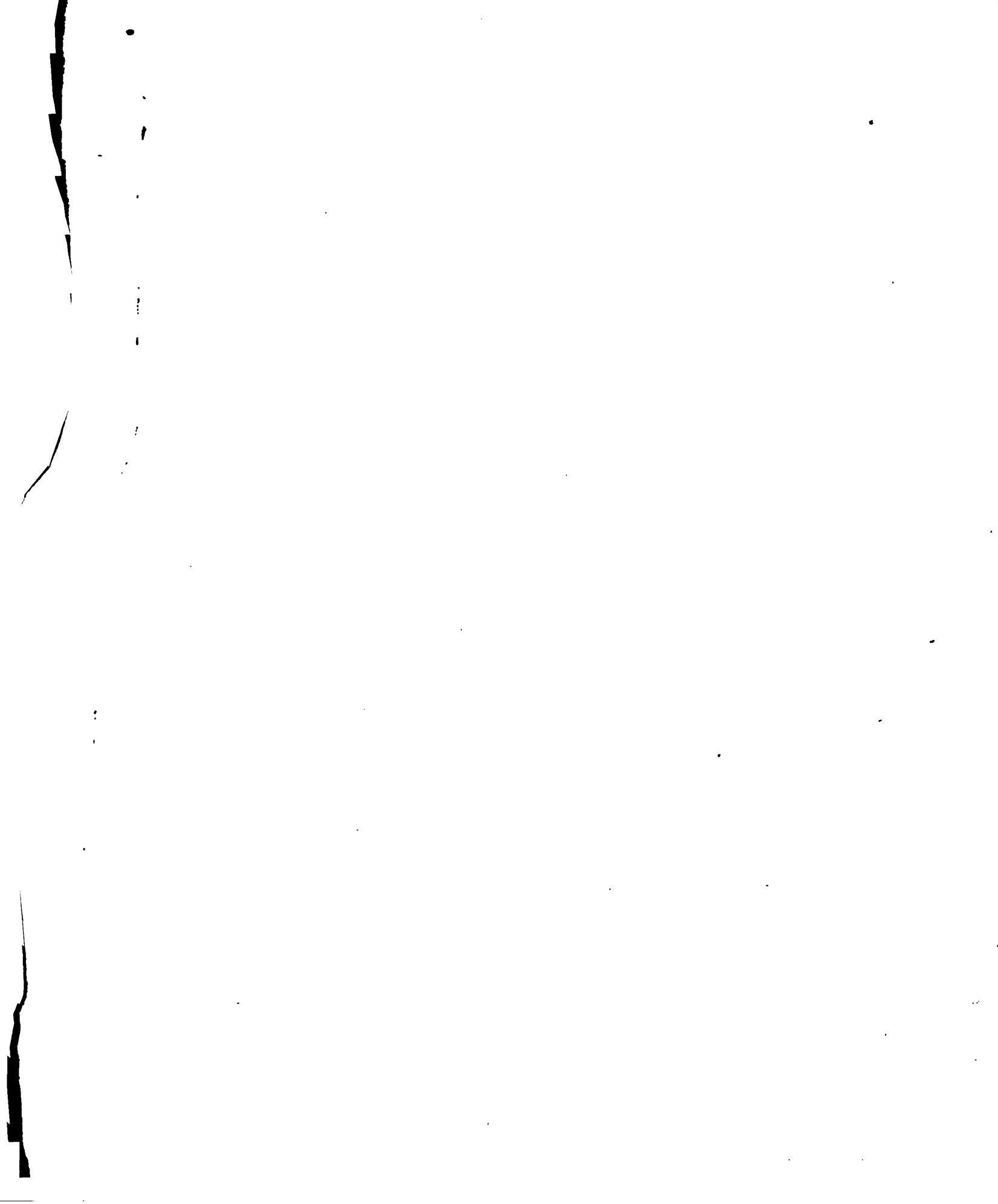
PARIS

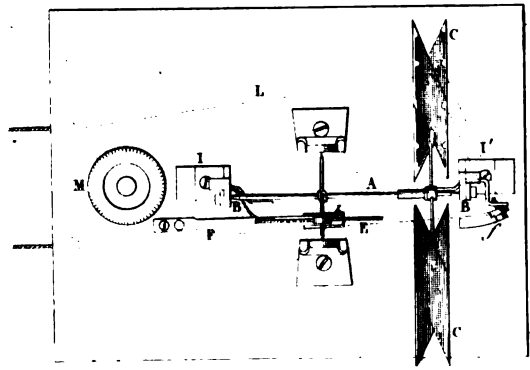
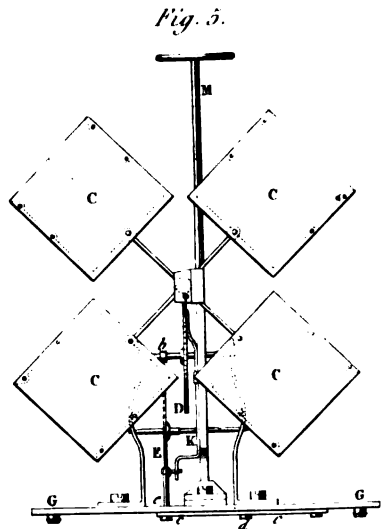
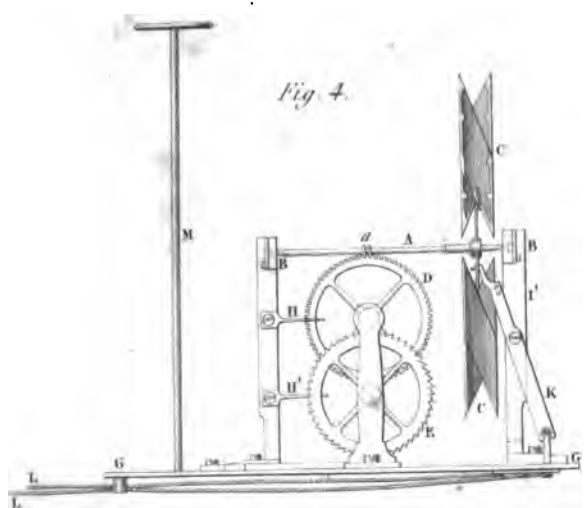
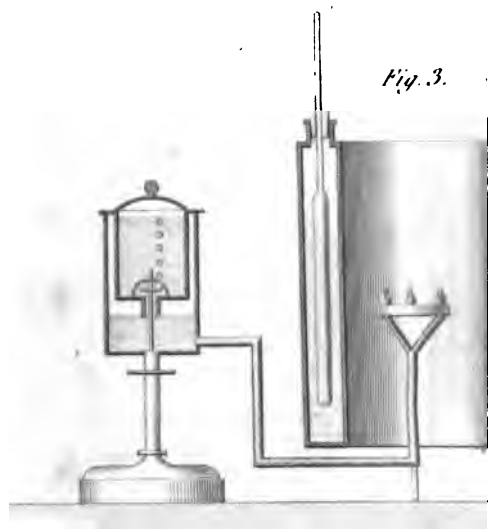
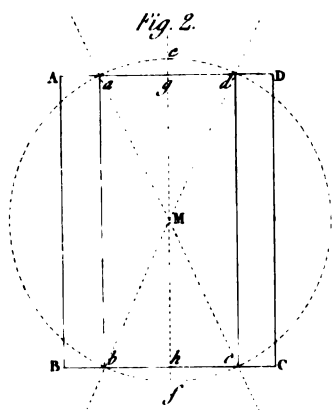
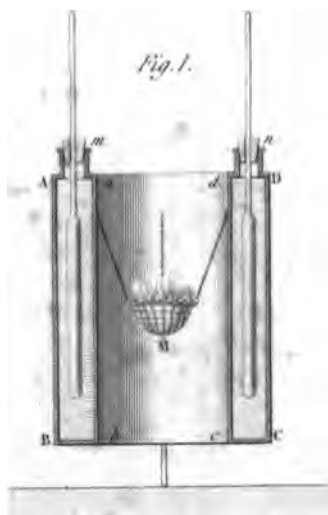
LIBRAIRIE DE L. HACHETTE

RUE PIERRE-SARRAZIN, 12

1843

BIBLIOTHÈQUE
DE L'UNIVERSITÉ
DE GAND.





Échelle des Fig. 4, 5 et 6.

Fig. 7.



Fig. 8.



Fig. 9.

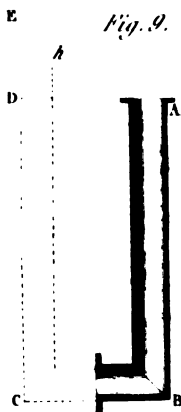


Fig. 10.

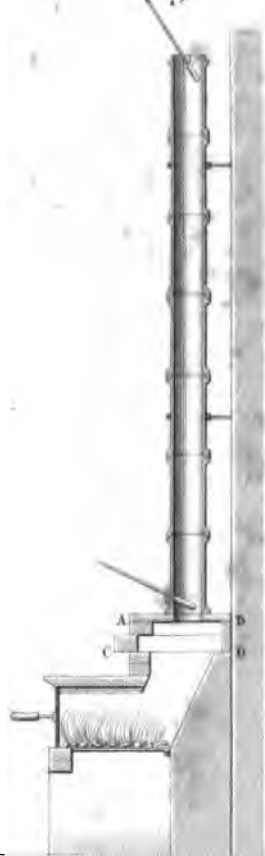


Fig. 12.

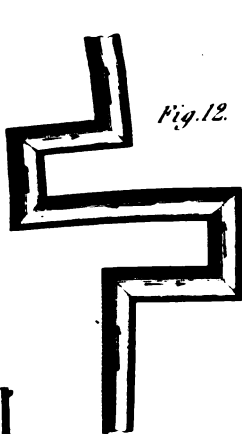


Fig. 13.

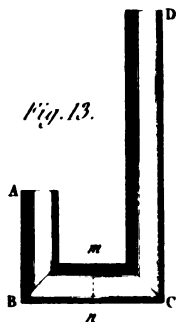


Fig. 11.

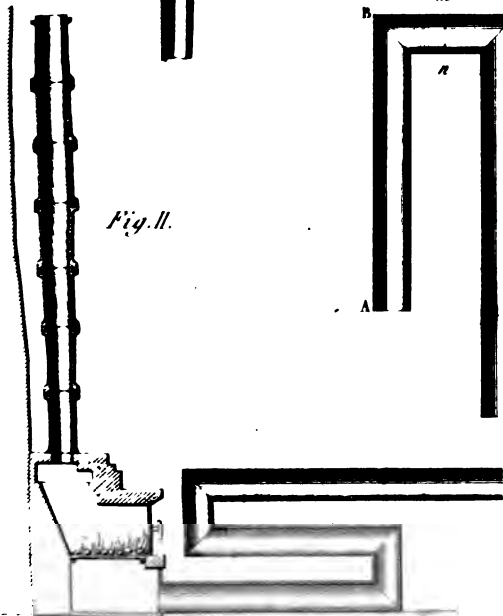
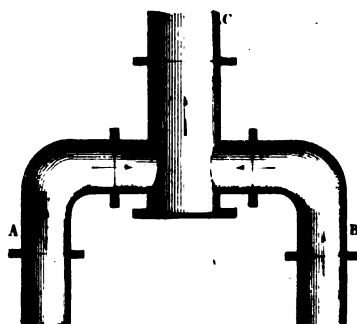
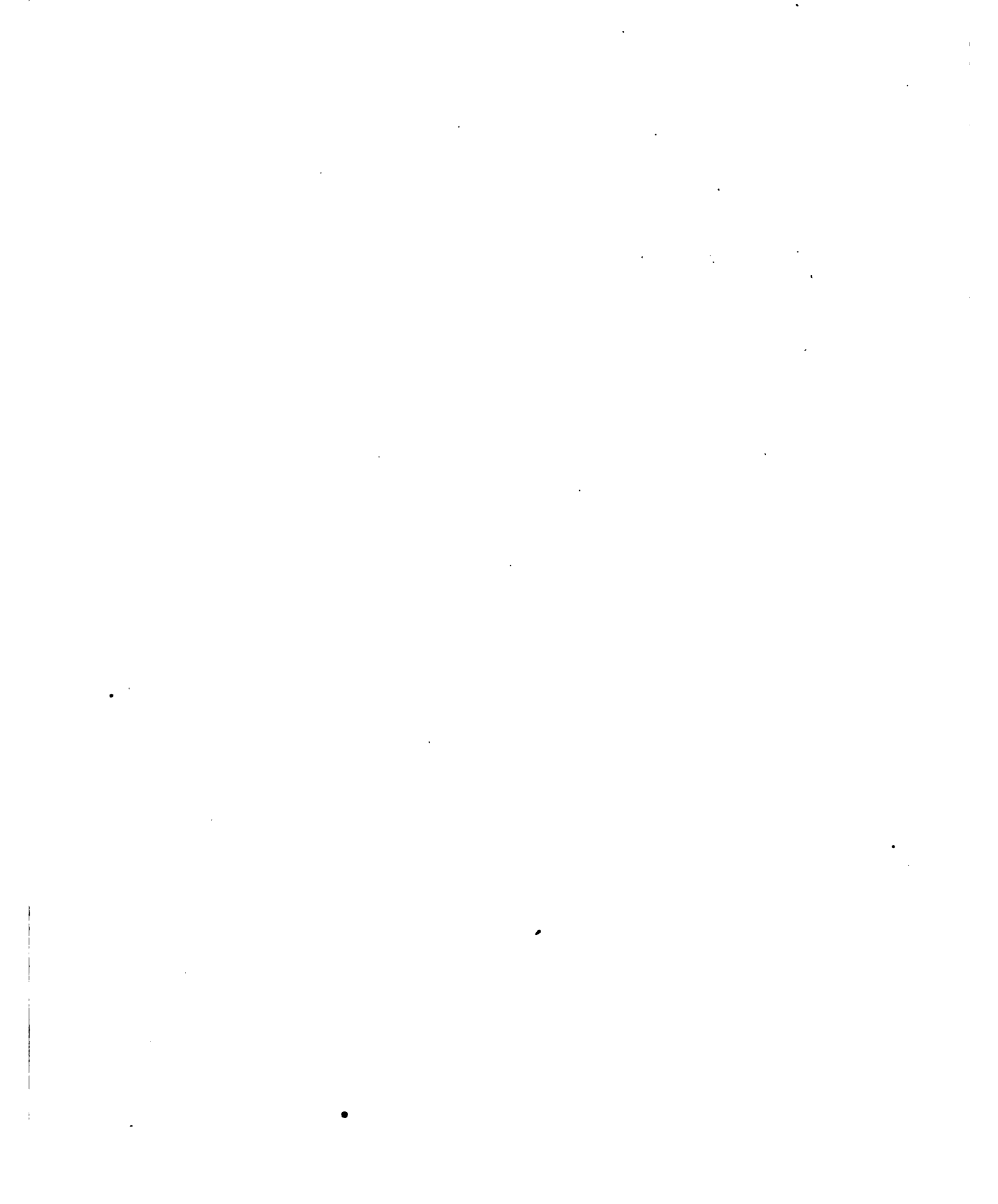


Fig. 14.

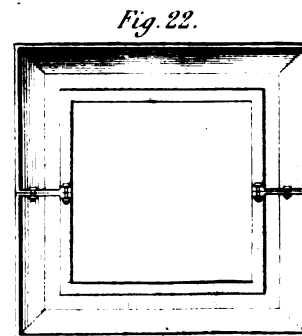
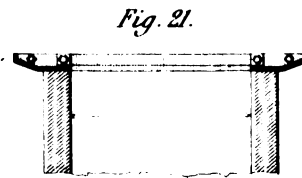
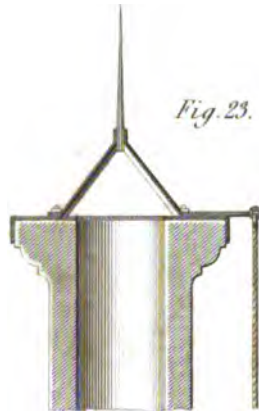
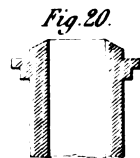
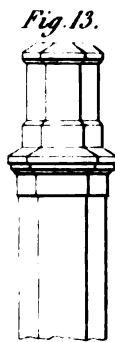
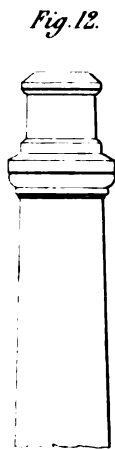
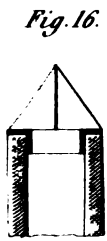
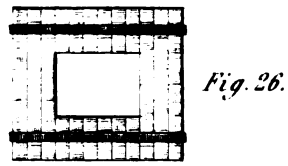
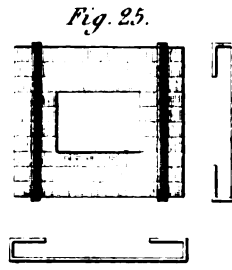
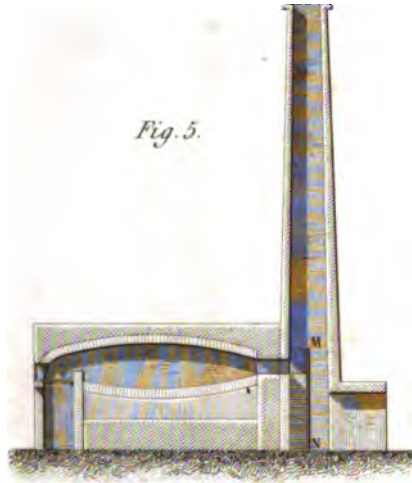
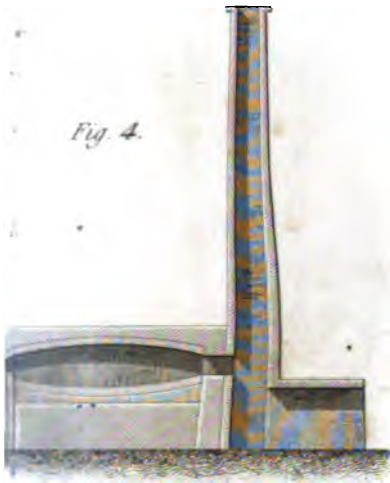


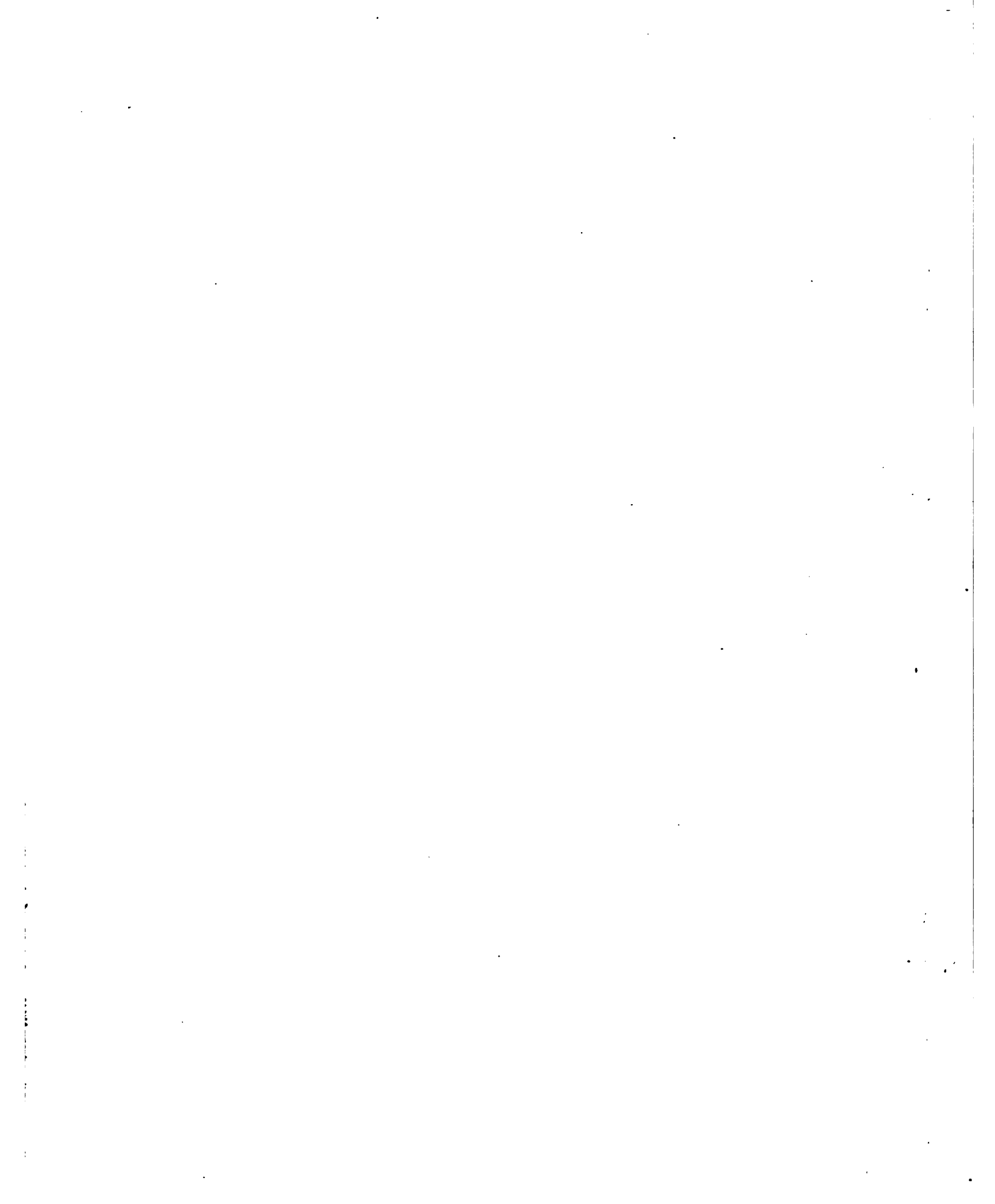
Fig. 13.

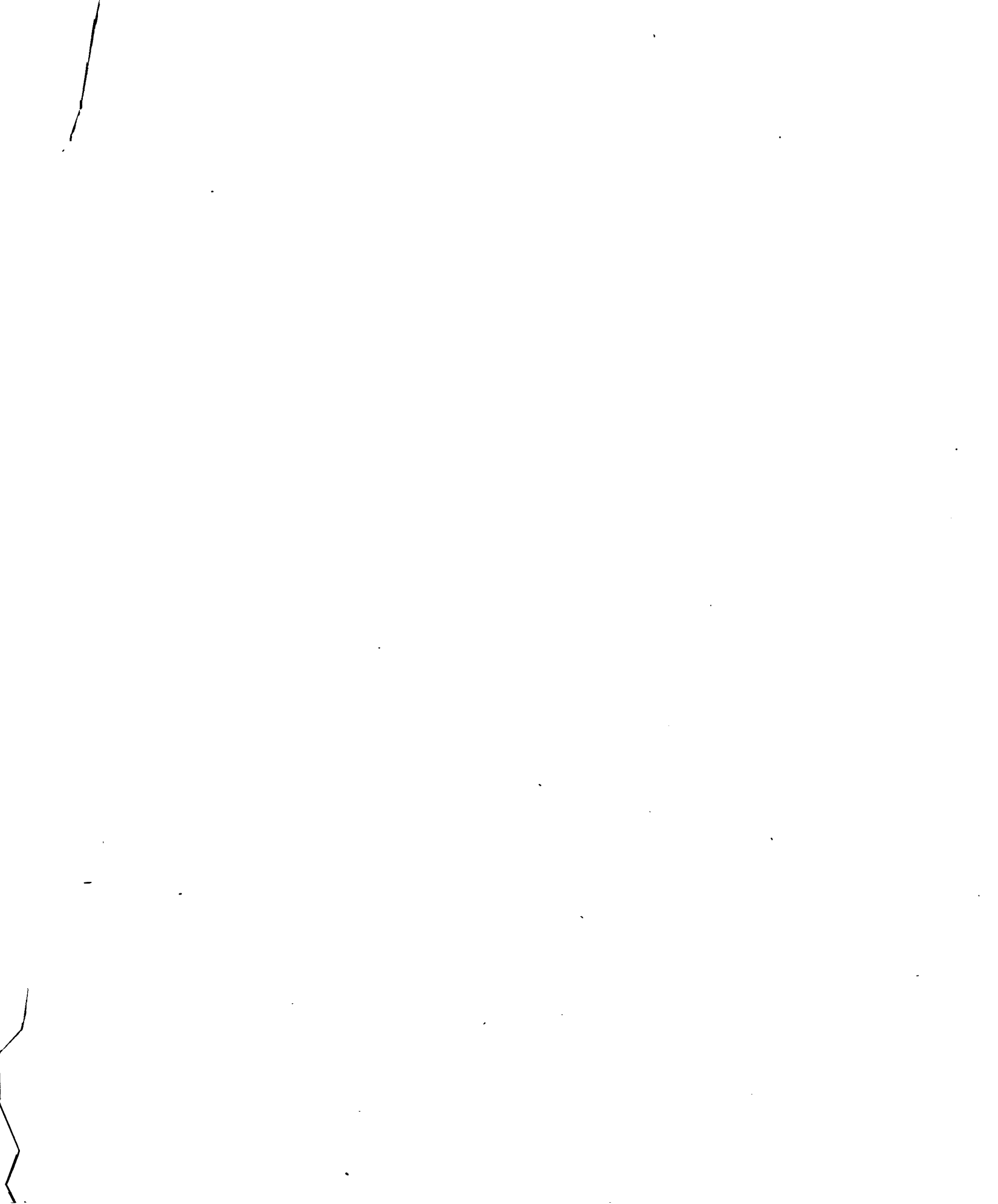












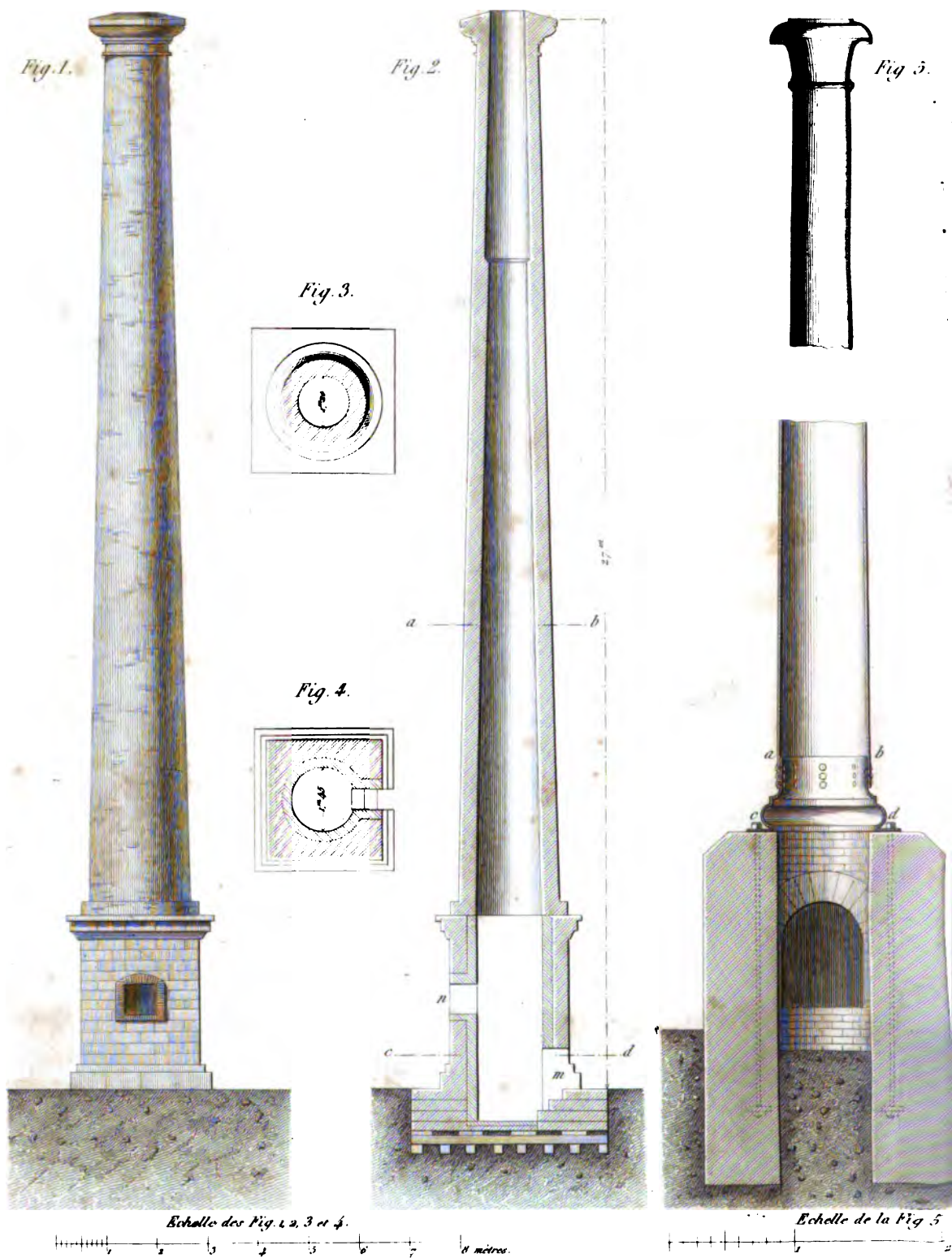




Fig. 6.

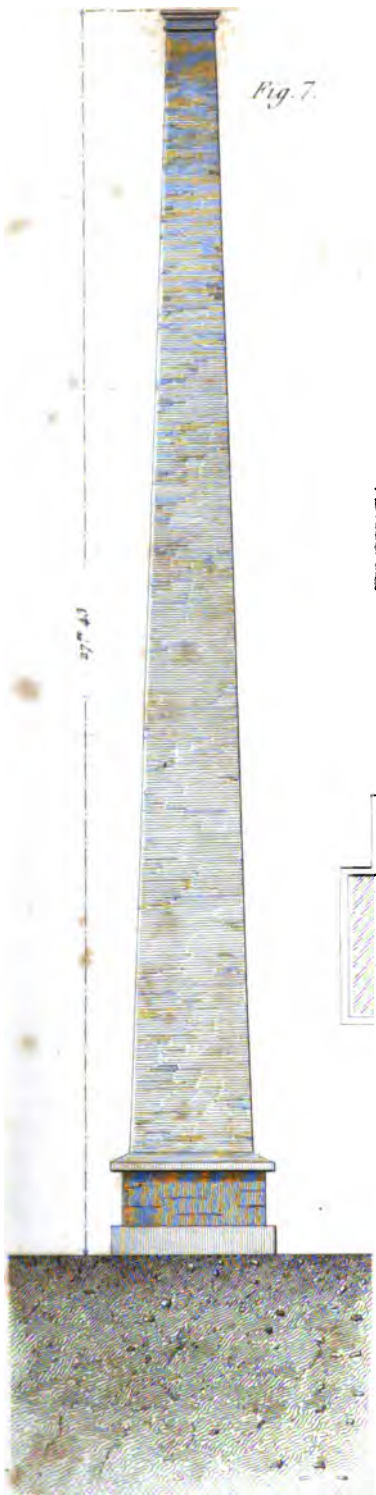


Fig. 7.



Fig. 9.



Fig. 10.

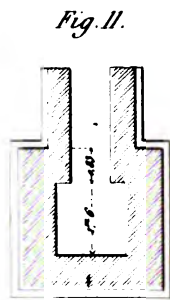


Fig. 11.

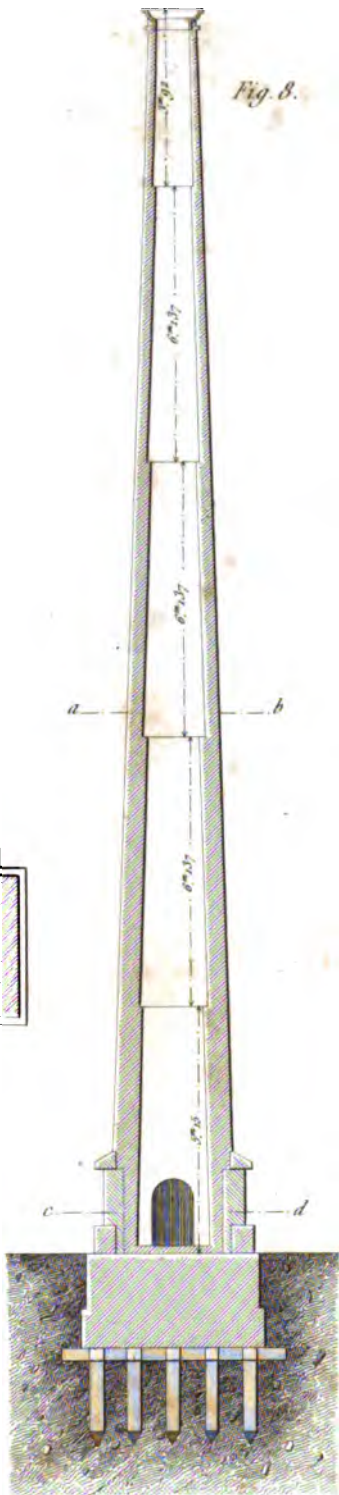
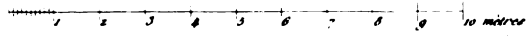


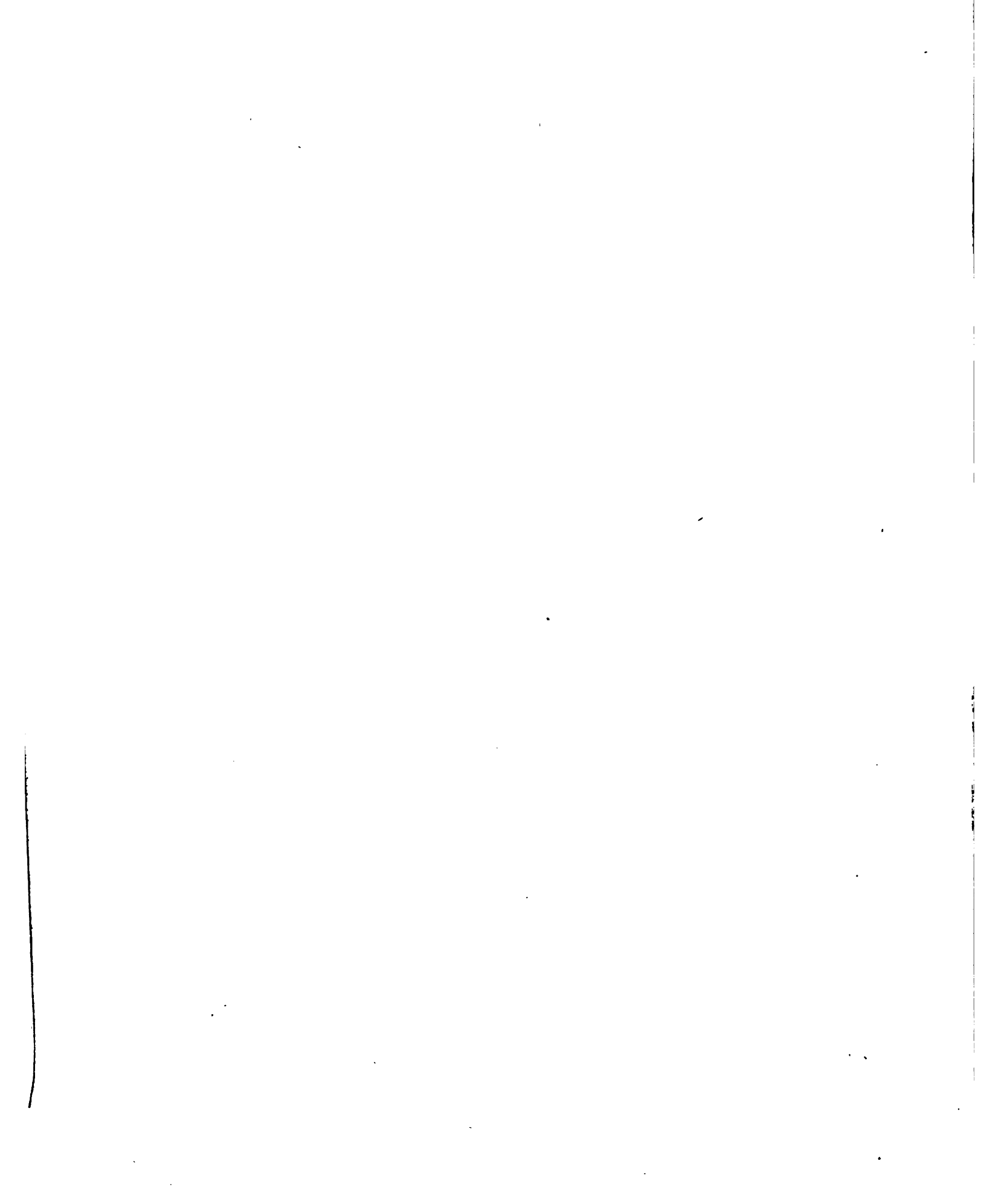
Fig. 8.

Échelle des Fig. 7, 8, 9, 10 et 11.

3 mètres



10 mètres



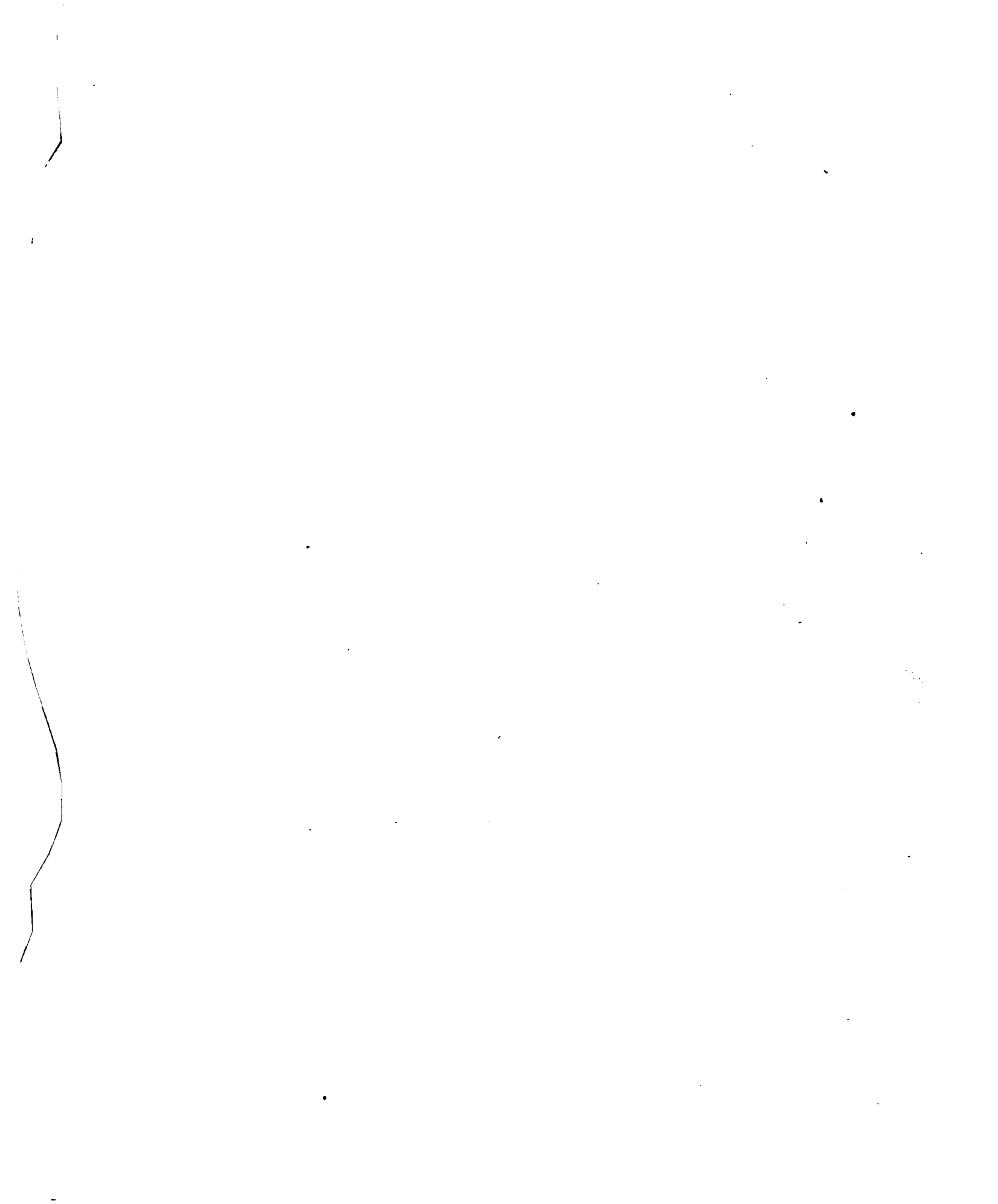


Fig. 1.

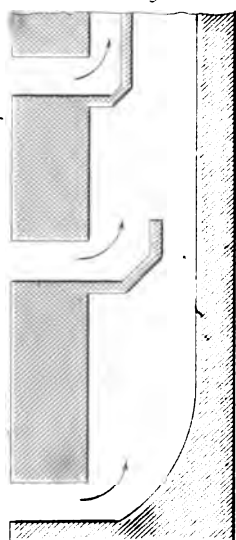


Fig. 2.

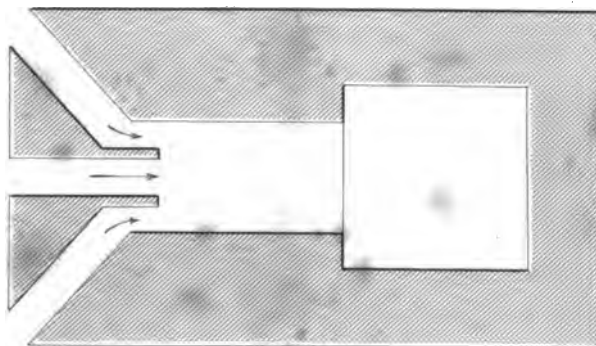


Fig. 10.

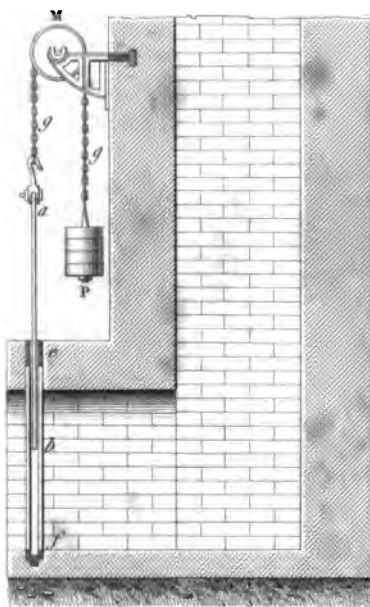


Fig. 11.

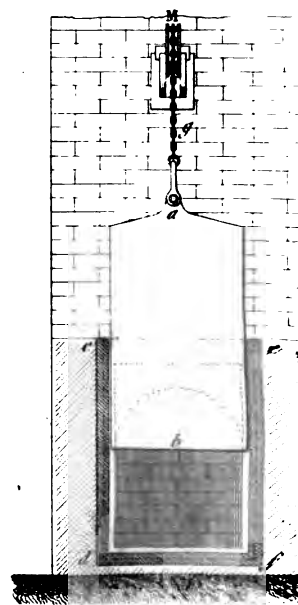


Fig. 8.

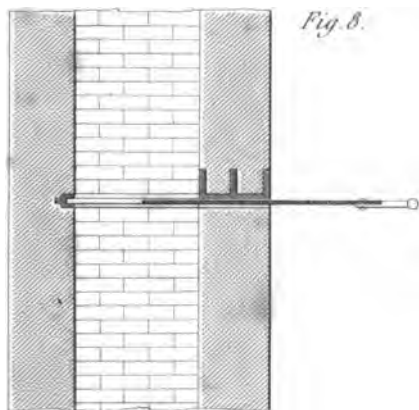


Fig. 9.

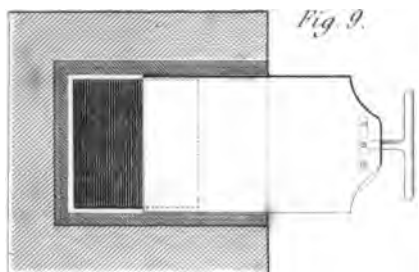


Fig. 15.

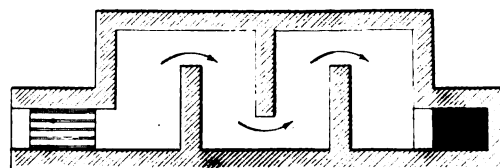
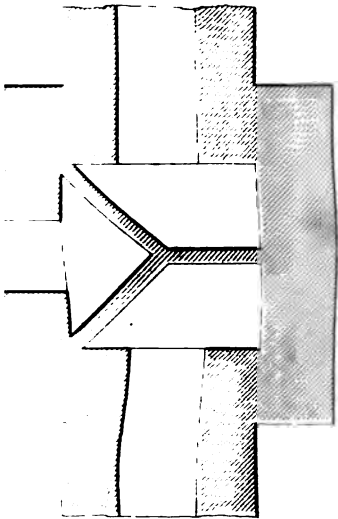


Fig. 3.



37
37
Fig. 4.

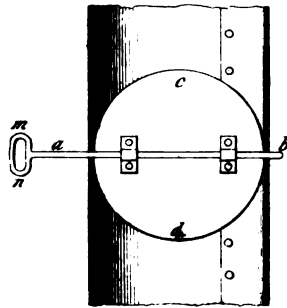


Fig. 6.

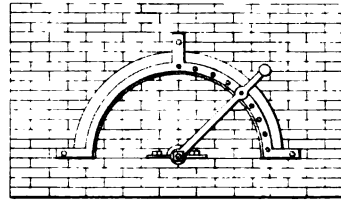


Fig. 5.

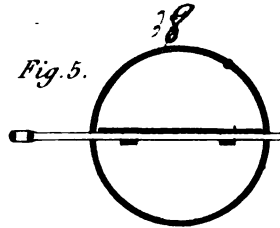


Fig. 7.

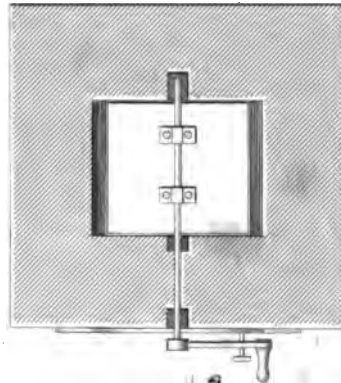


Fig. 12.

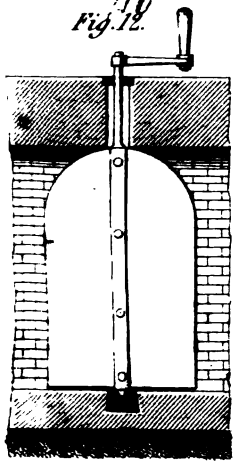


Fig. 13.

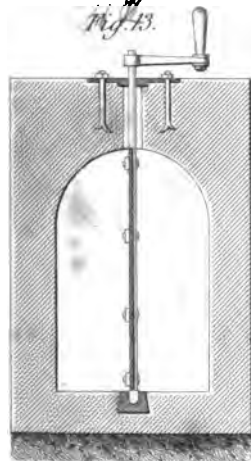


Fig. 14.

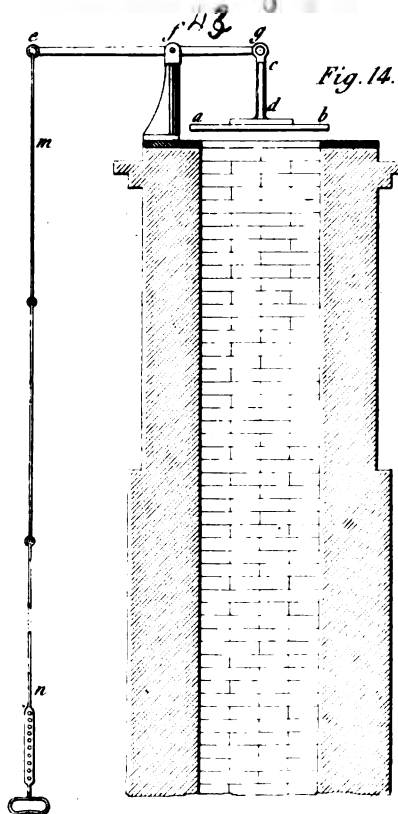
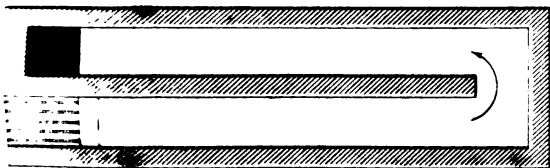
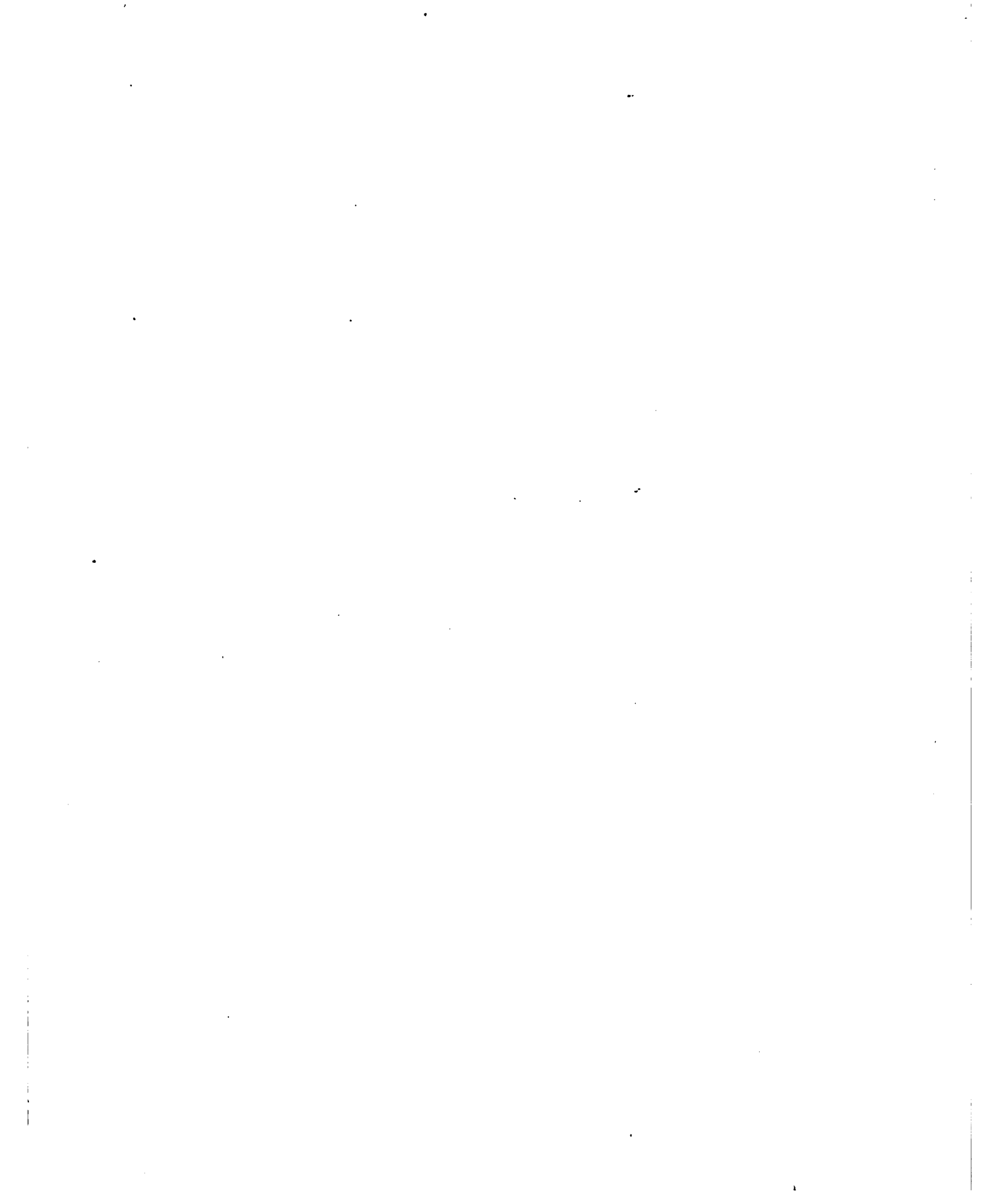


Fig. 16.







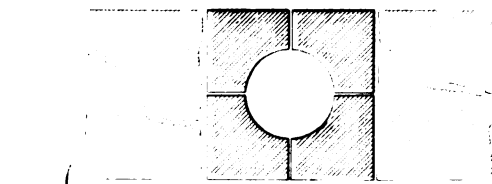


Fig. 1.

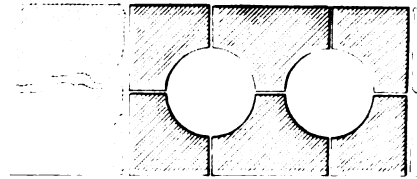


Fig. 2.

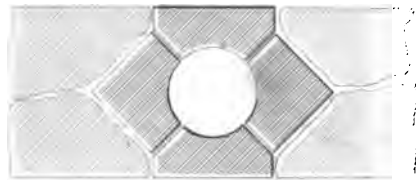


Fig. 5.

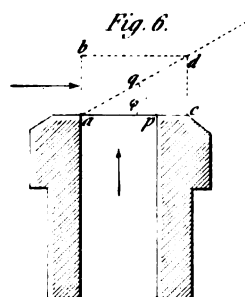
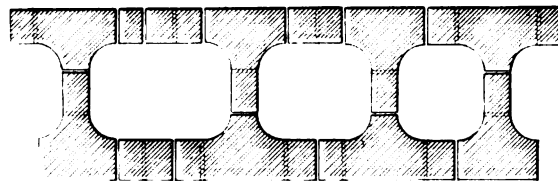
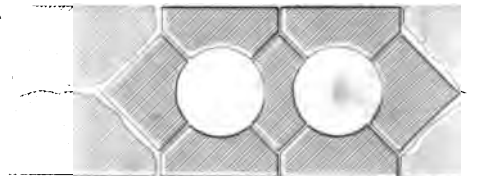


Fig. 6.

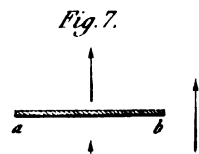


Fig. 7.

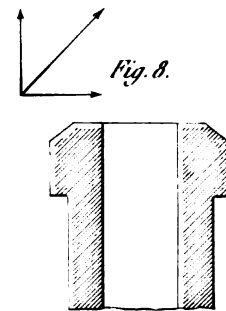


Fig. 8.

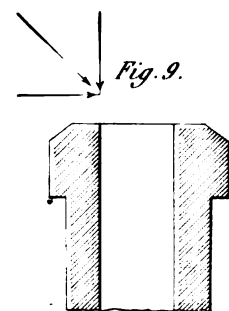


Fig. 9.

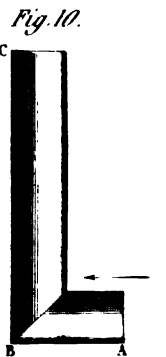


Fig. 10.

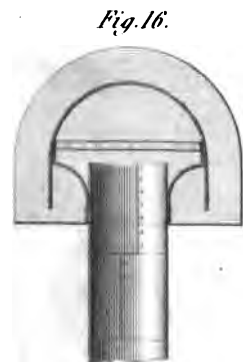


Fig. 16.

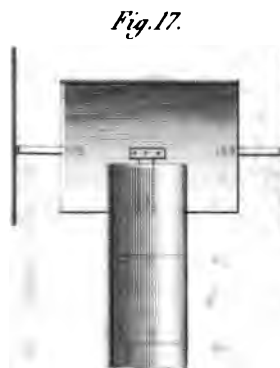


Fig. 17.



Fig. 18.

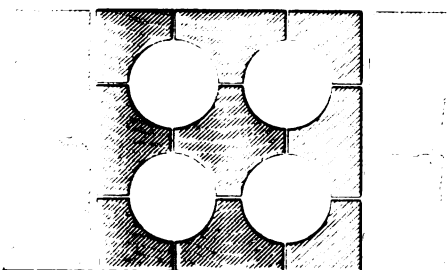


Fig. 3.

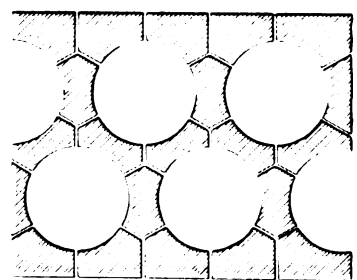


Fig. 4.

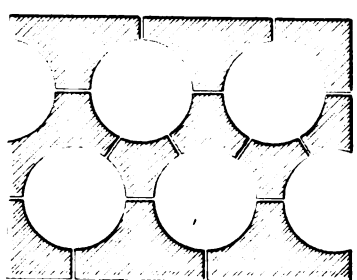
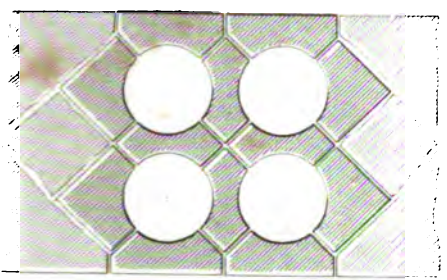


Fig. 11.

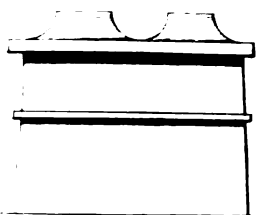


Fig. 12.

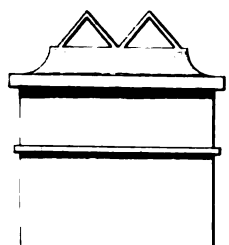


Fig. 13.



Fig. 14.

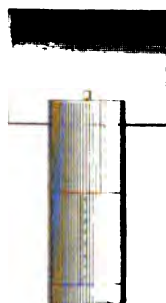


Fig. 15.



Fig. 19.



Fig. 20.



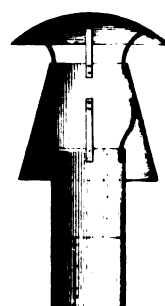
Fig. 21.



Fig. 22.



Fig. 23.



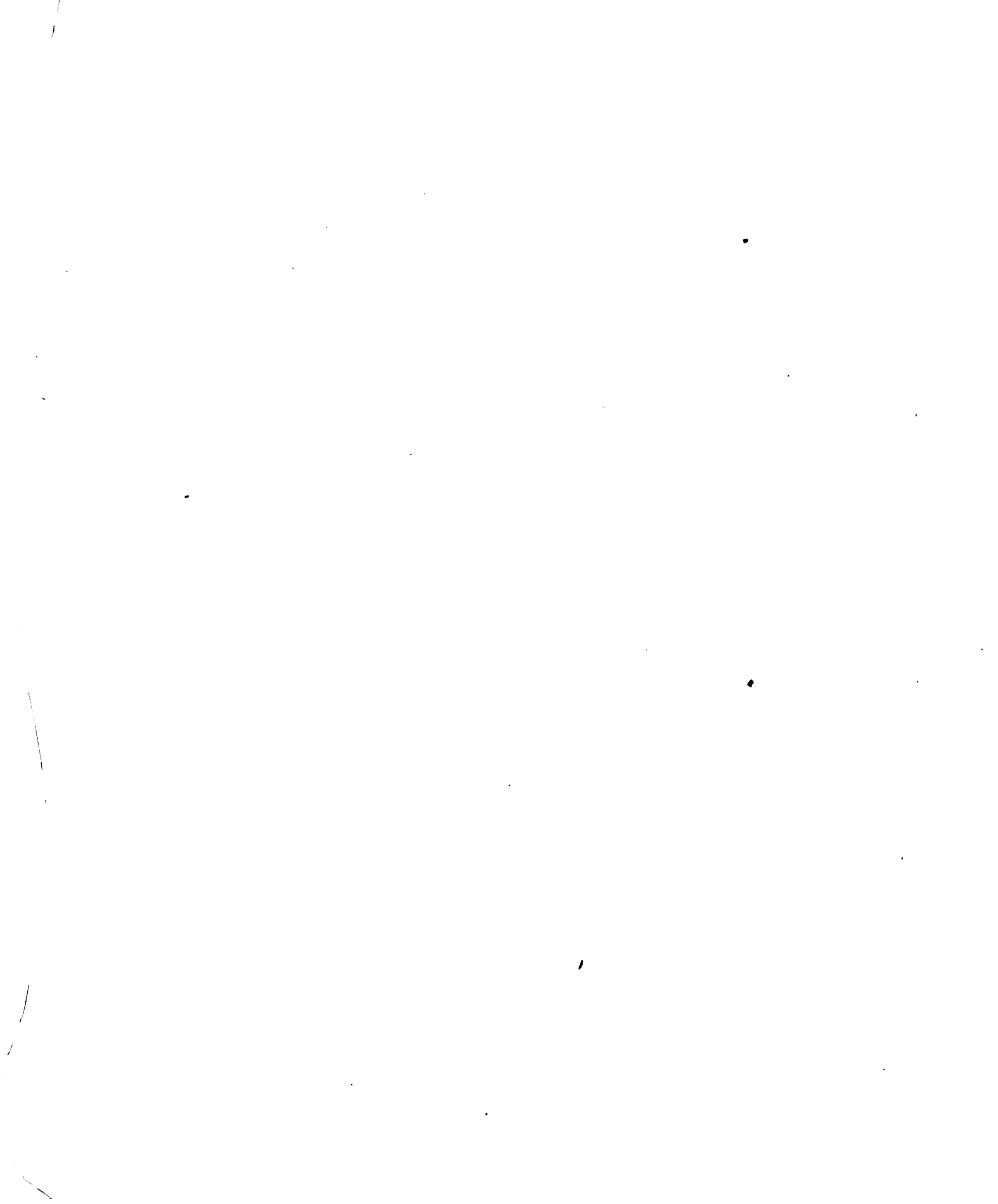


Fig. 2.

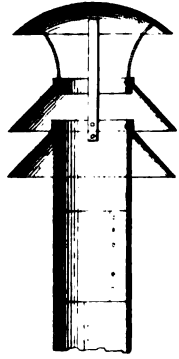


Fig. 1.

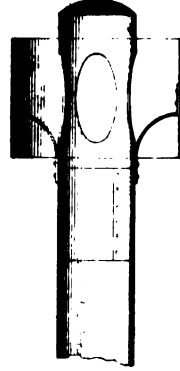


Fig. 3.

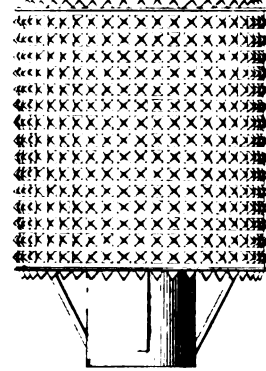


Fig. 4.



Fig. 9.

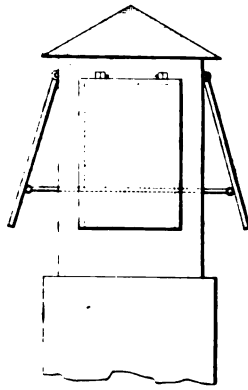


Fig. 10.

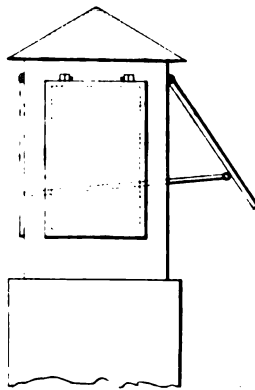


Fig. 8.

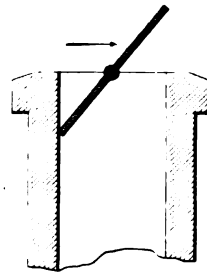


Fig. 7.

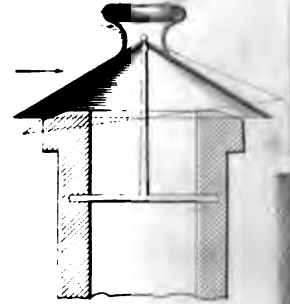


Fig. 6.

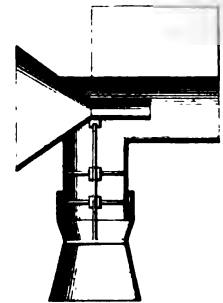


Fig. 14.

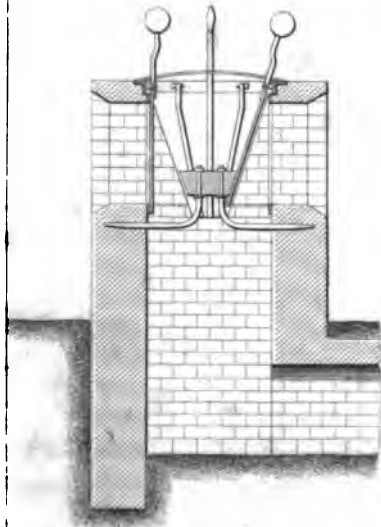


Fig. 15.

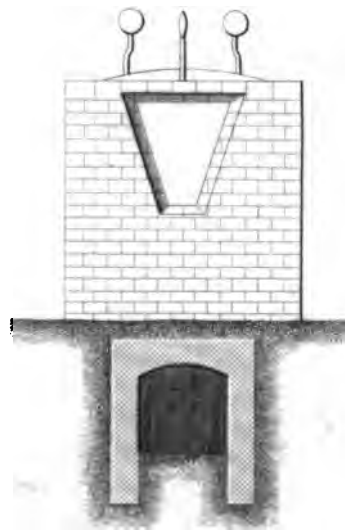


Fig. 13.

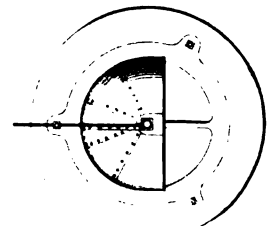
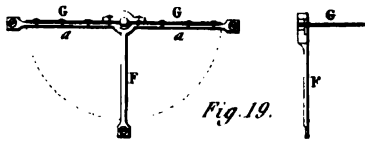
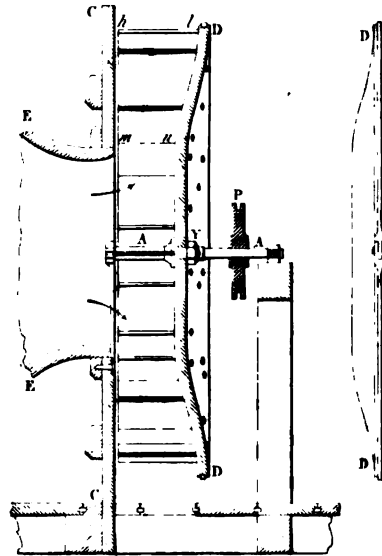
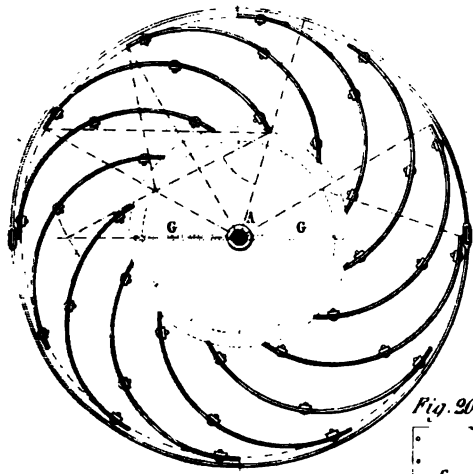
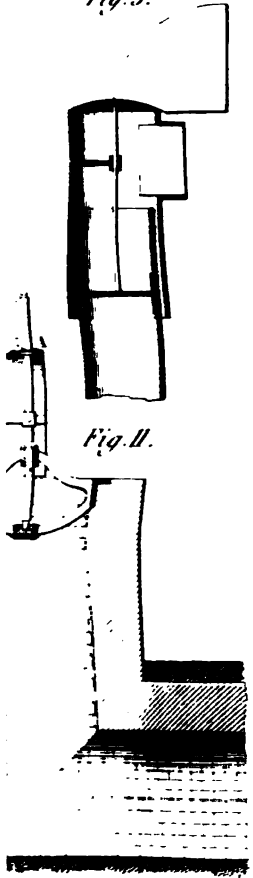


Fig. 5.

Fig. 16.

Fig. 17.

Fig. 18.



Echelle des Fig. 16, 17, 22, 23.

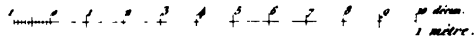
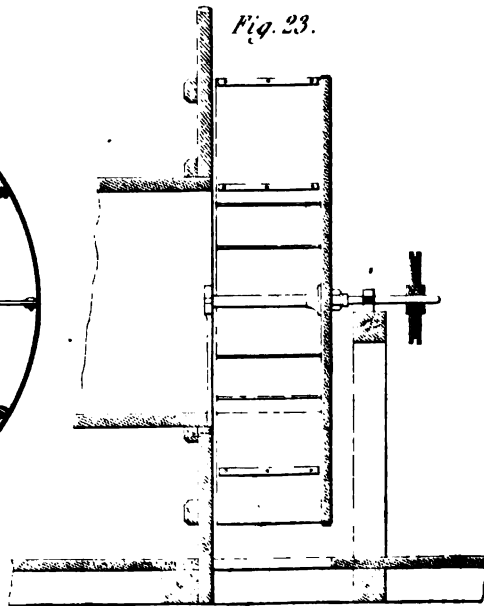
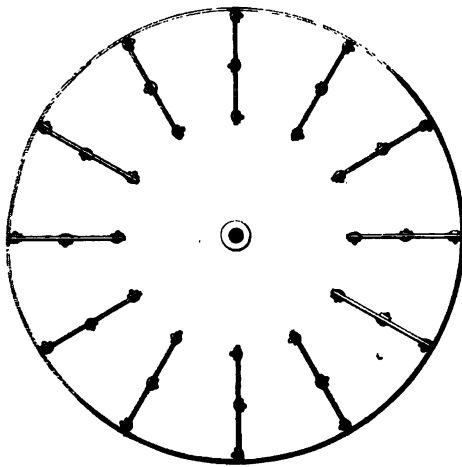
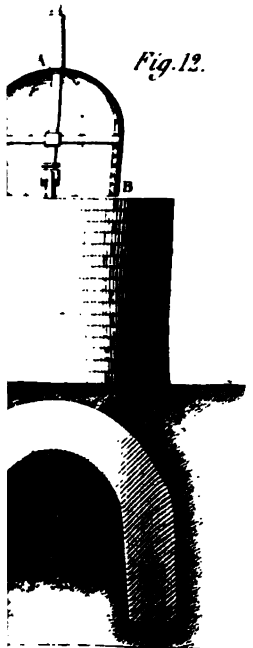
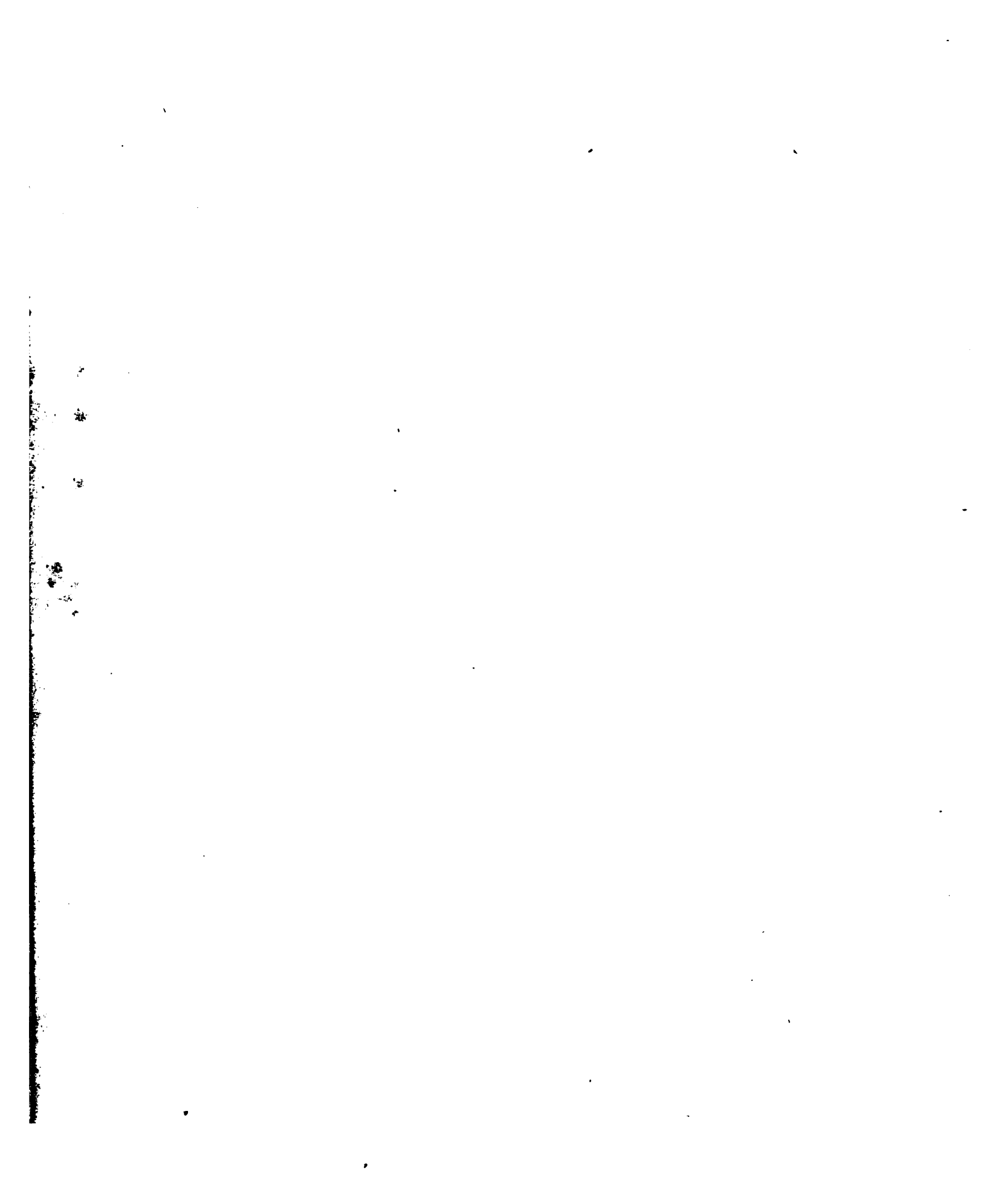


Fig. 13.

Fig. 22.

Fig. 23.







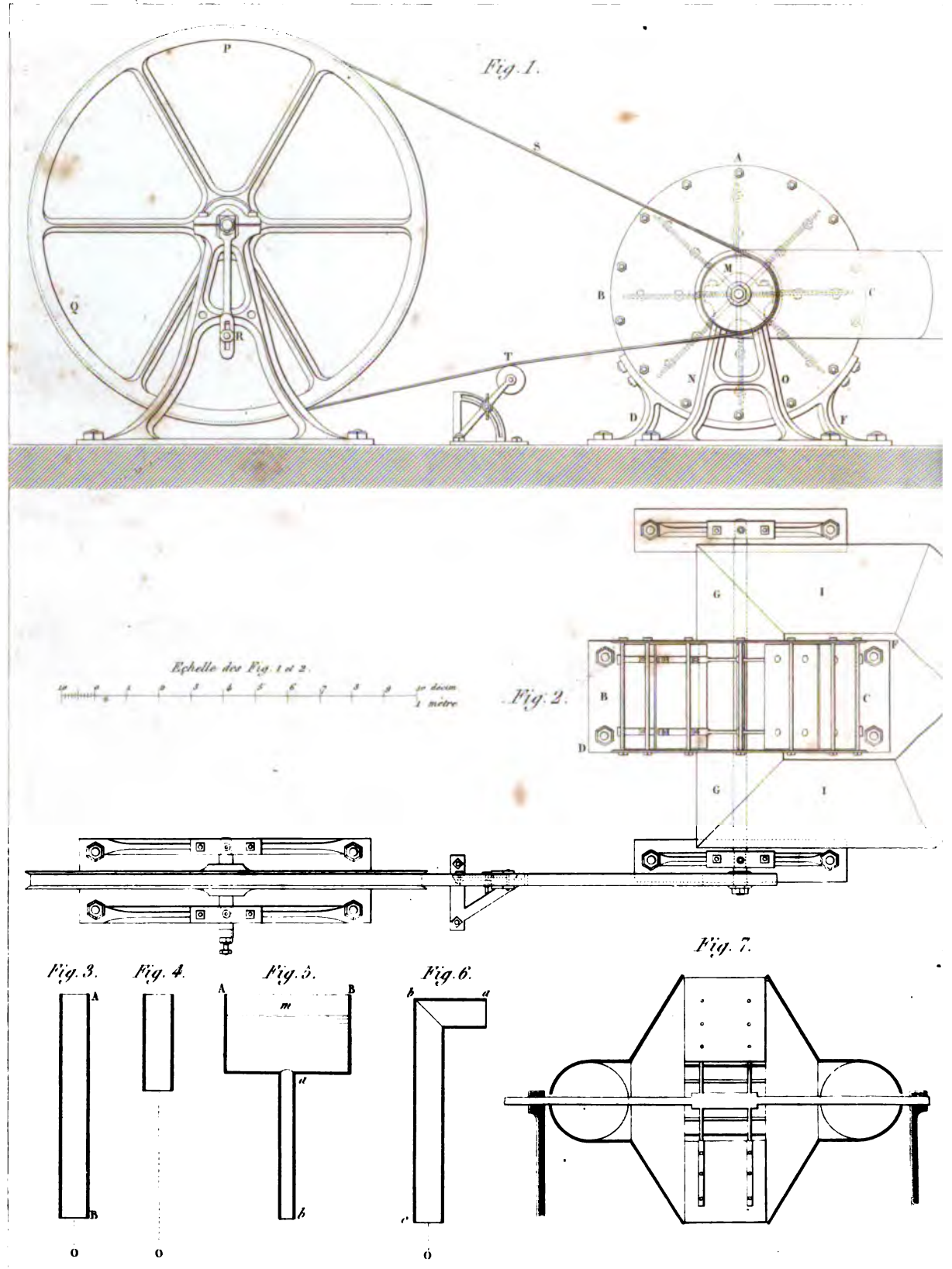


Fig. 8.

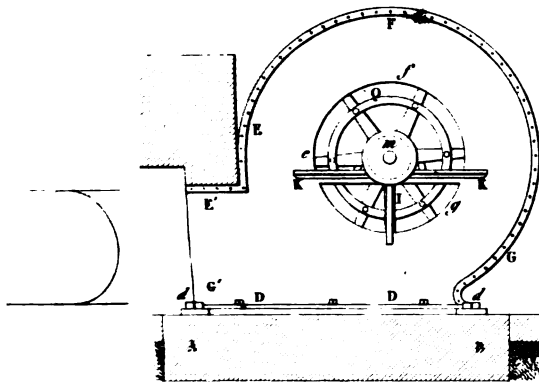


Fig. 9.

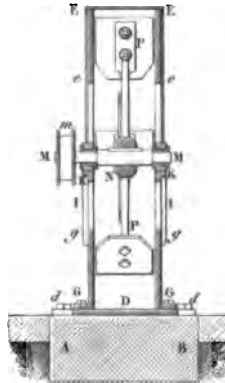
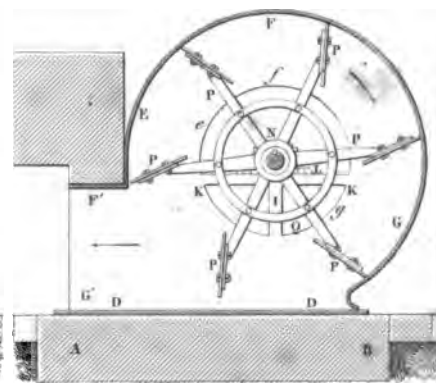
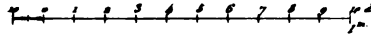


Fig. 10.



Echelle des Fig. 8, 9, 10.



Echelle des Fig. 13 et 16.

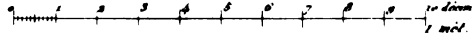


Fig. 11.

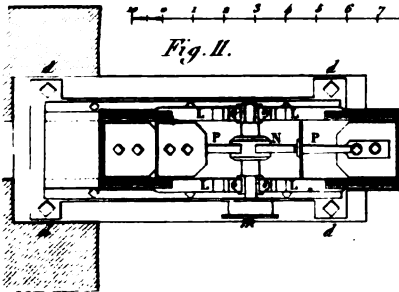


Fig. 12.

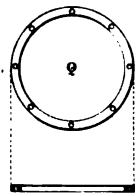


Fig. 13.

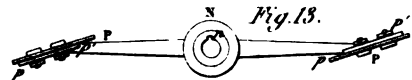


Fig. 14.

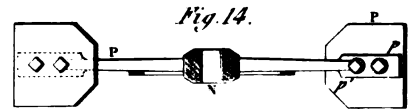


Fig. 15.

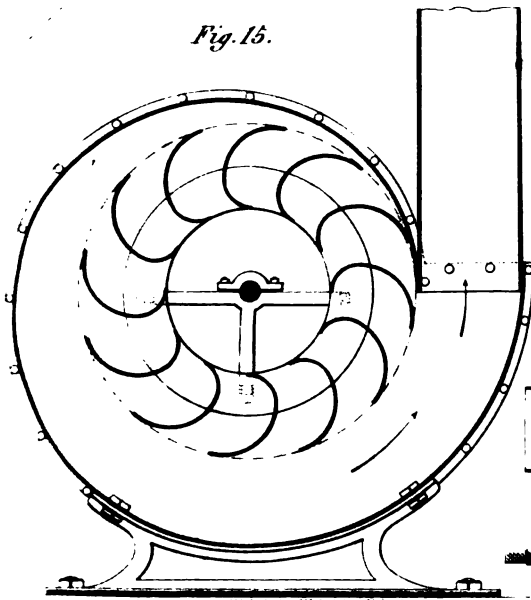


Fig. 16.

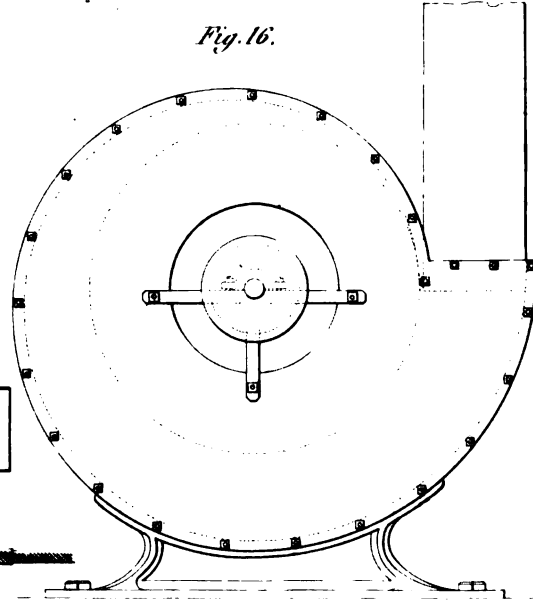
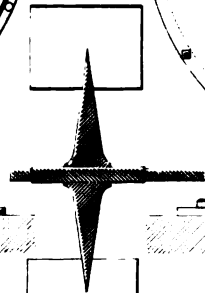
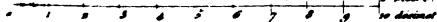
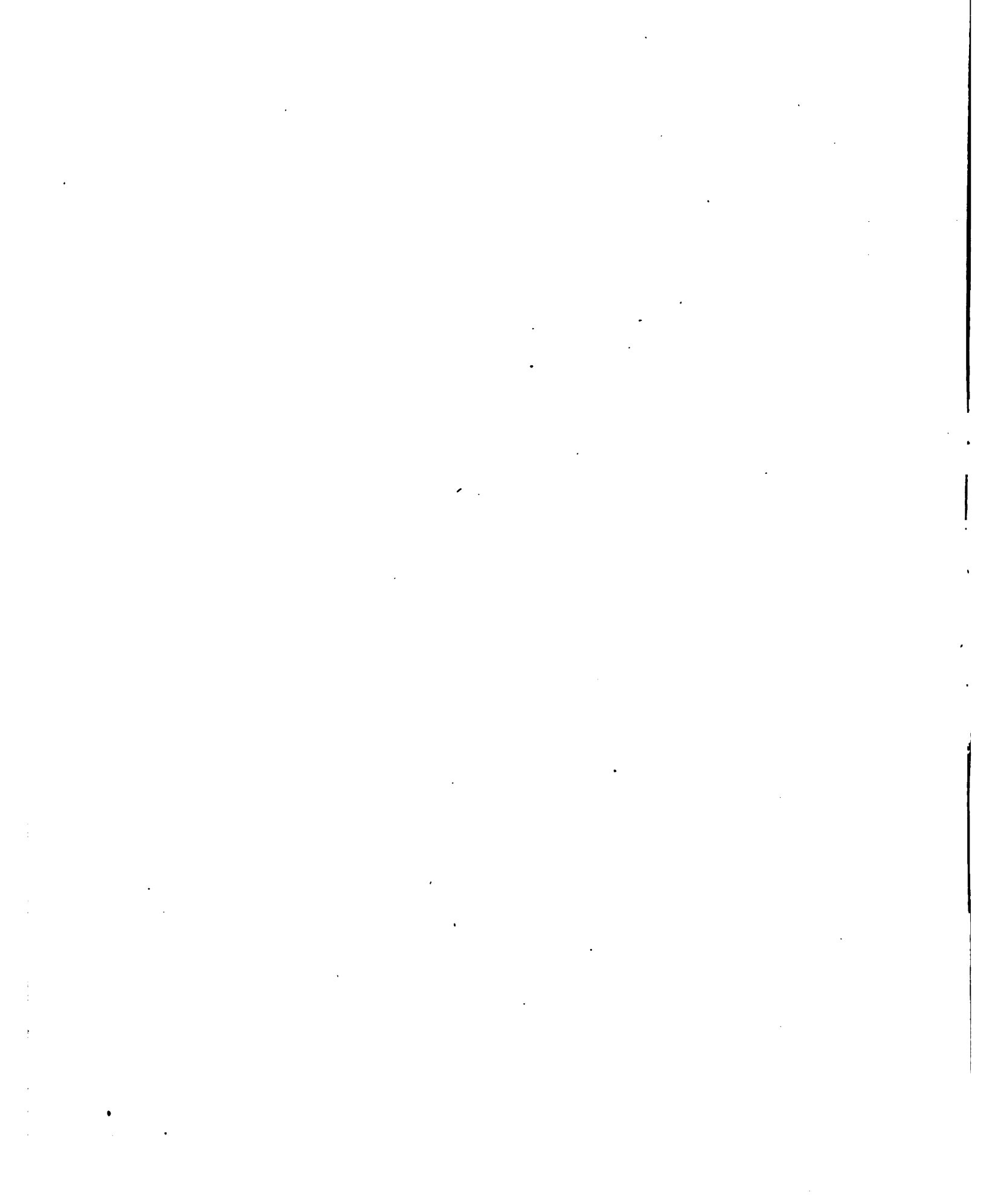


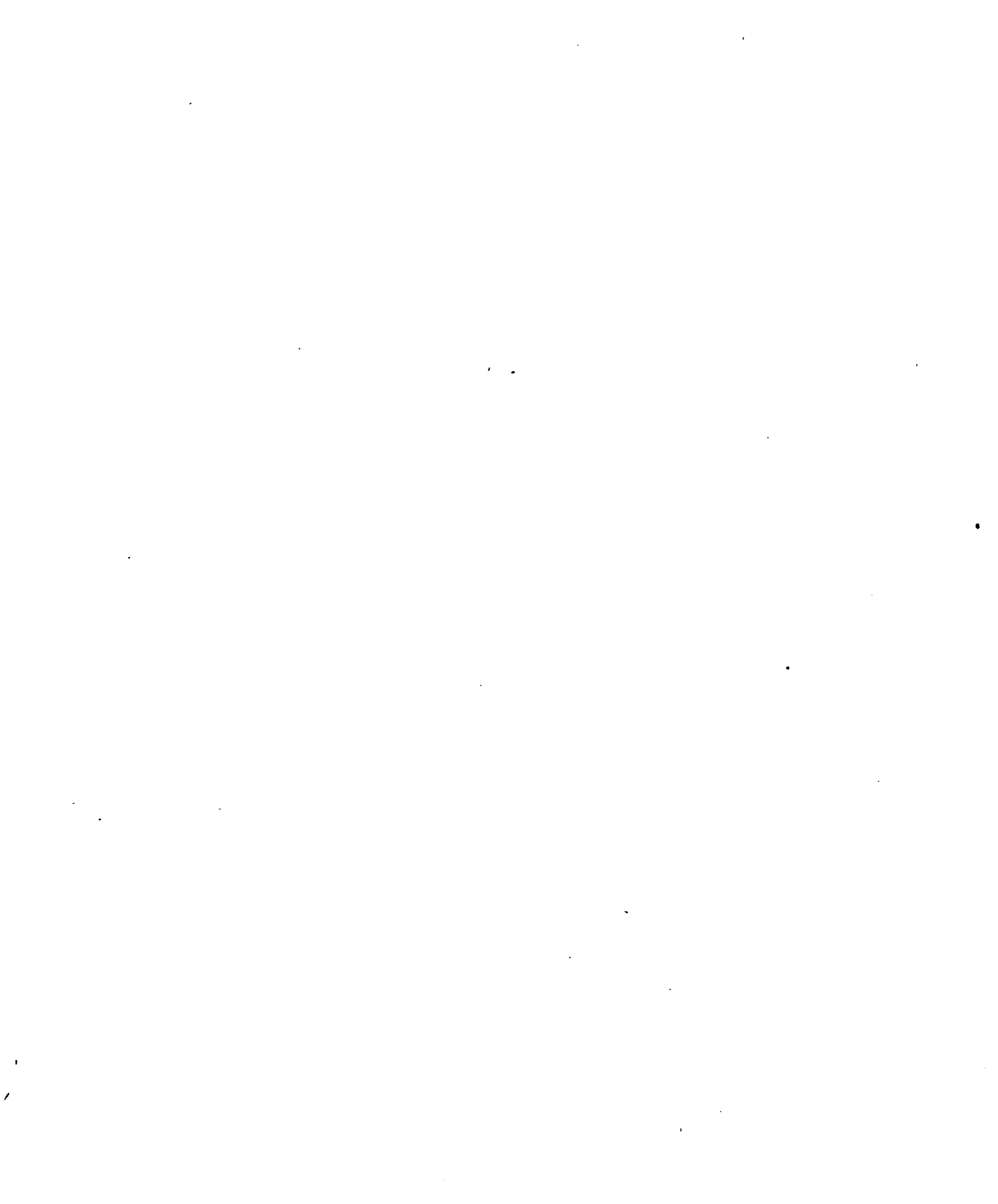
Fig. 17.



Echelle des Fig. 15, 16 et 17.







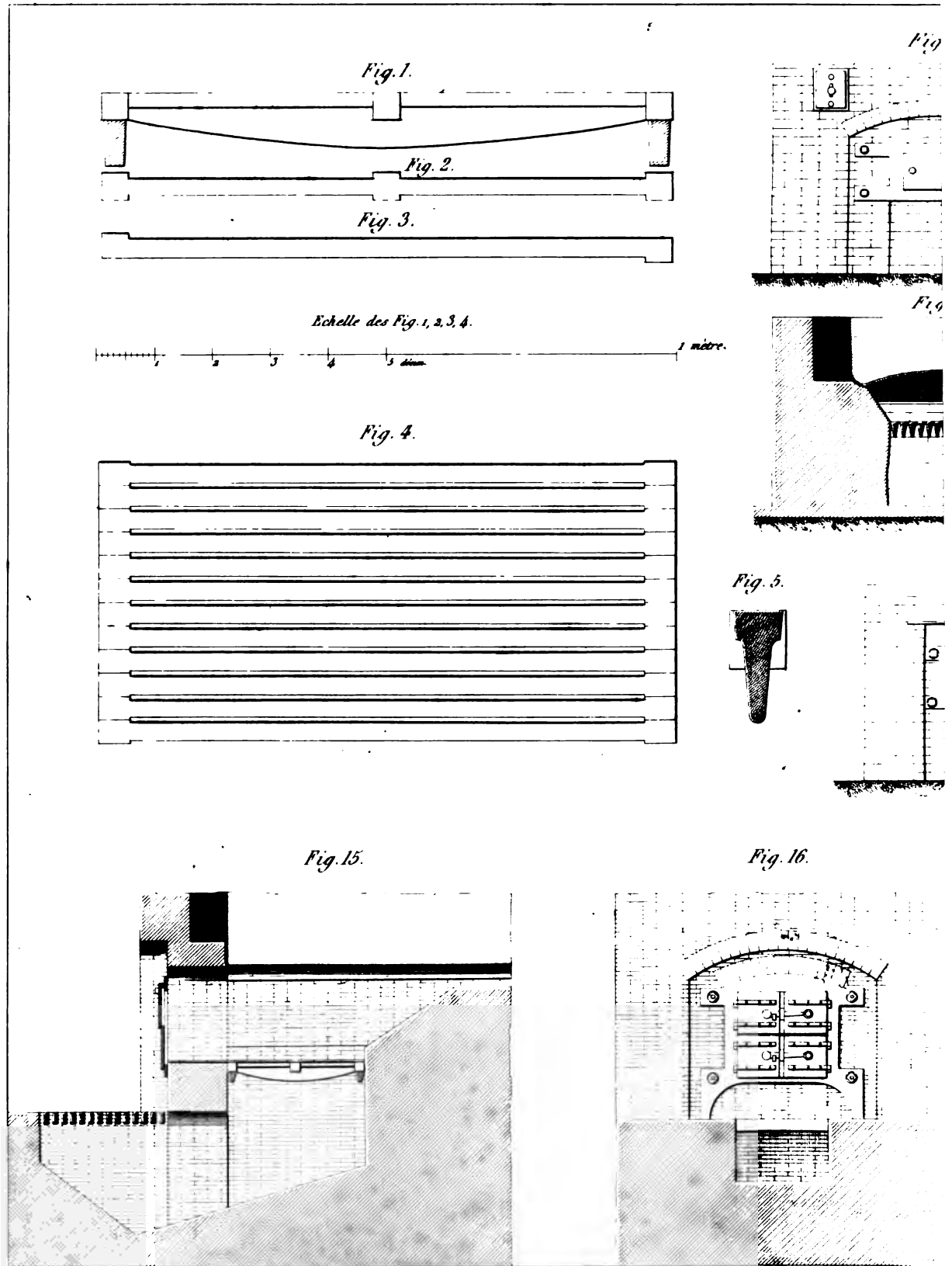
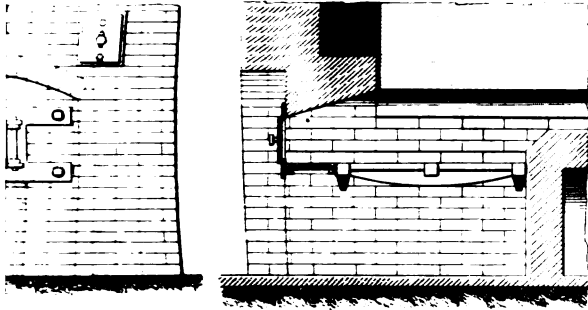


Fig. 8.



Echelle des Fig. 7, 8, 9, 10.

Fig. 10.



Fig. 14.

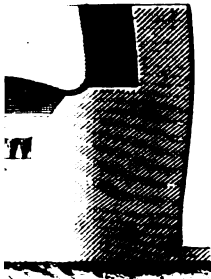
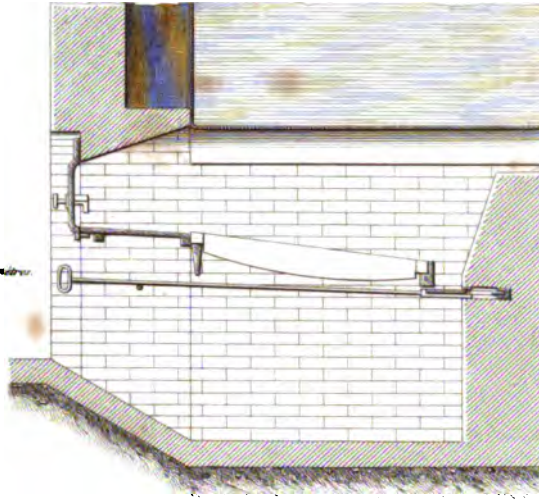


Fig. 11.

Fig. 12.

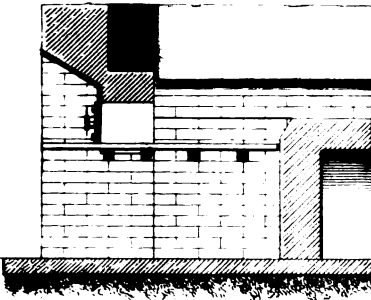


Fig. 13.

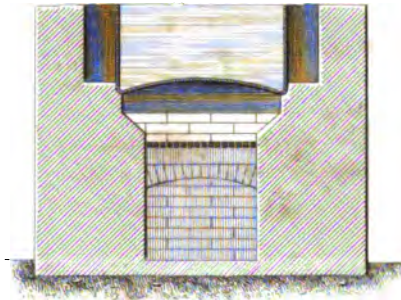


Fig. 17.

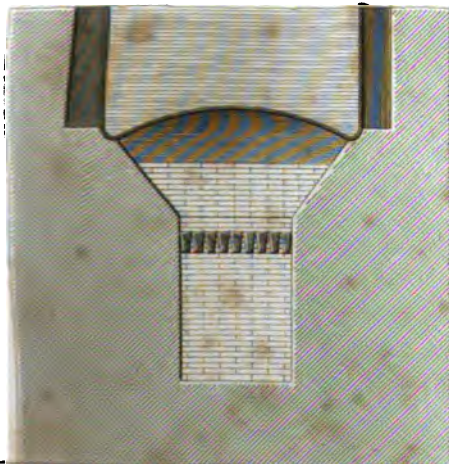
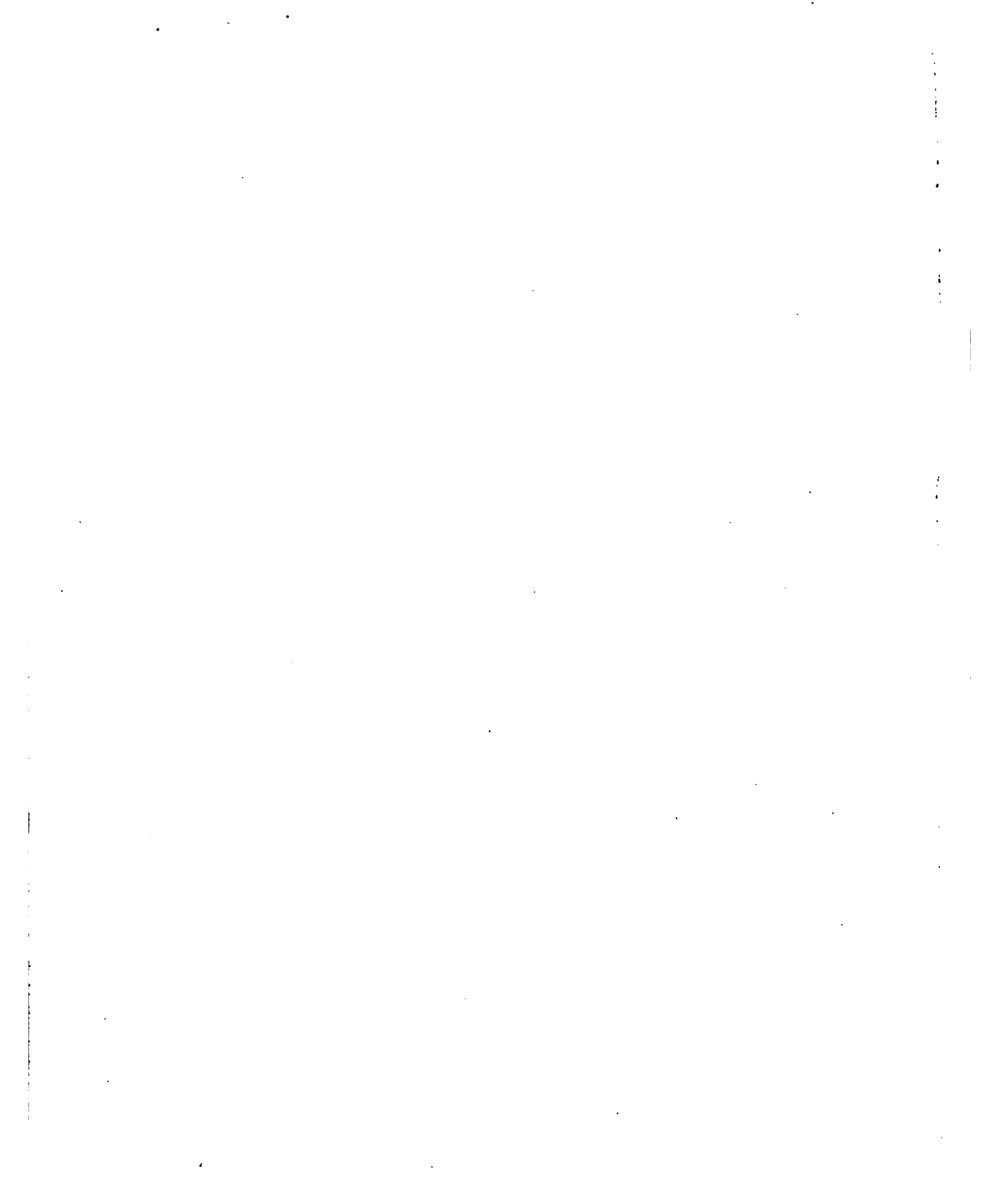


Fig. 18.





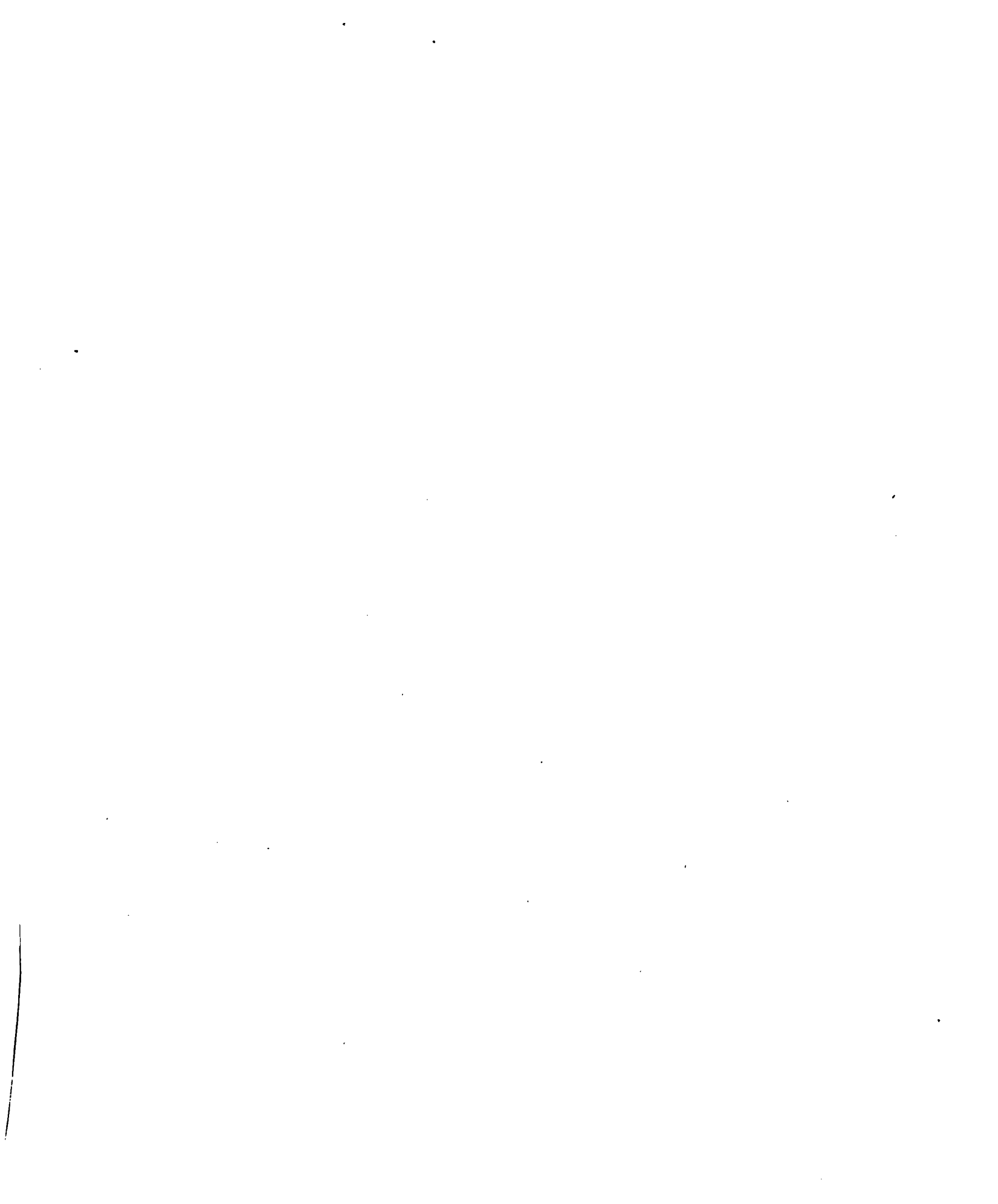


Fig. 1.

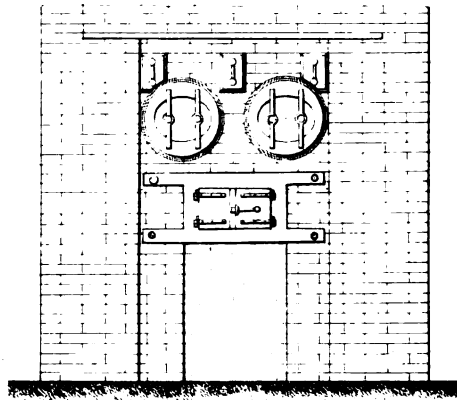
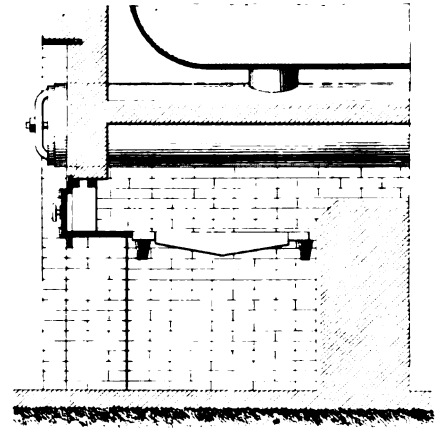


Fig. 2.



Echelle des Fig. 1, 2 et 3.

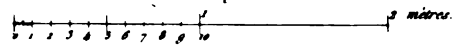


Fig. 4.

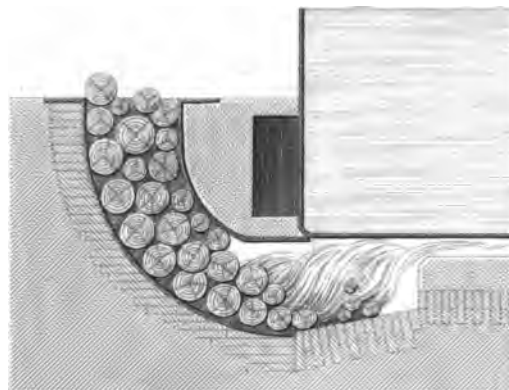


Fig. 6.

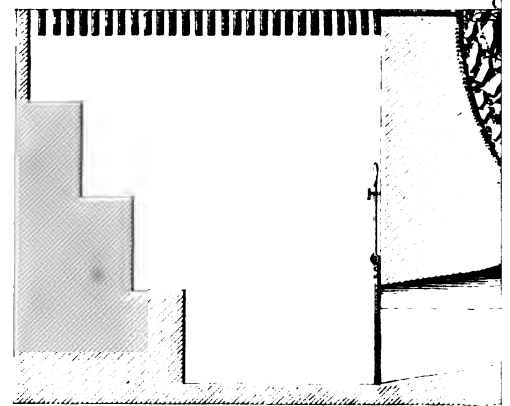


Fig. 5.

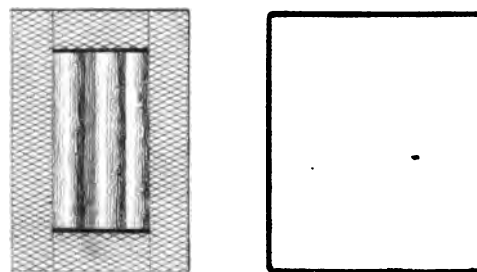
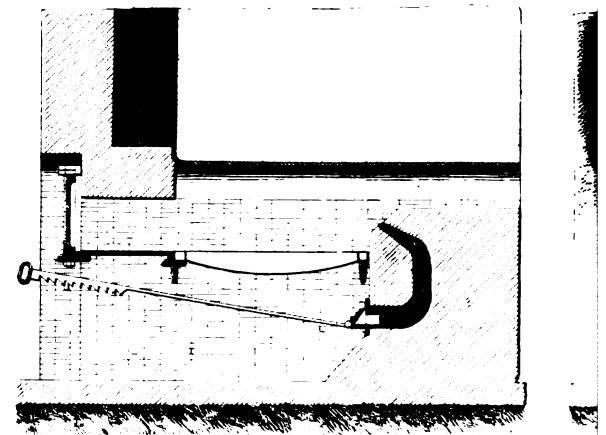


Fig. 7.



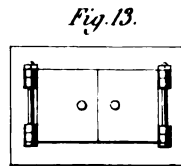
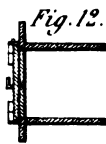
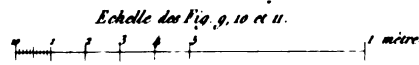
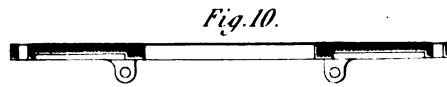
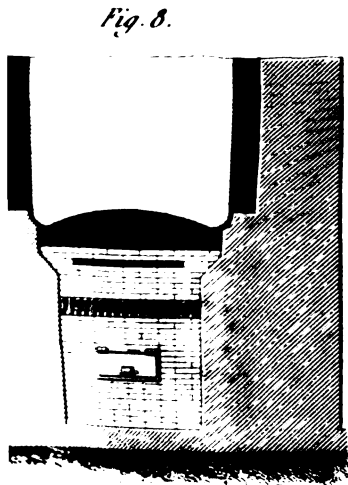
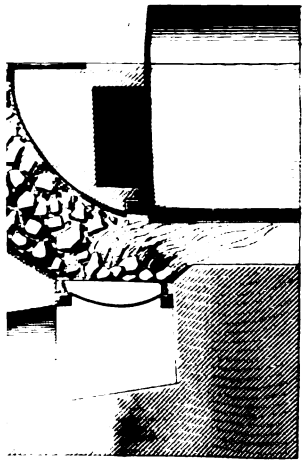
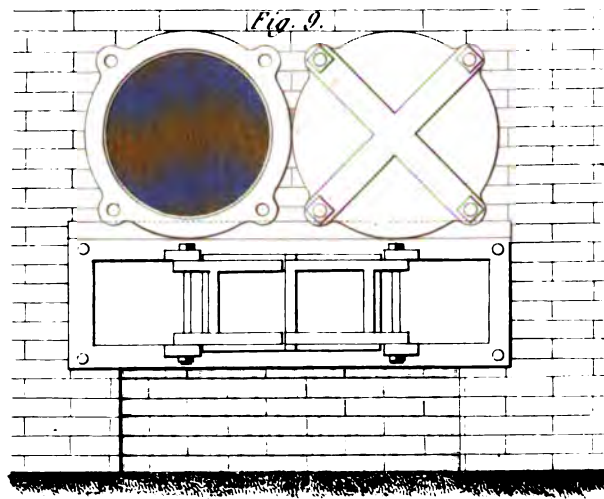
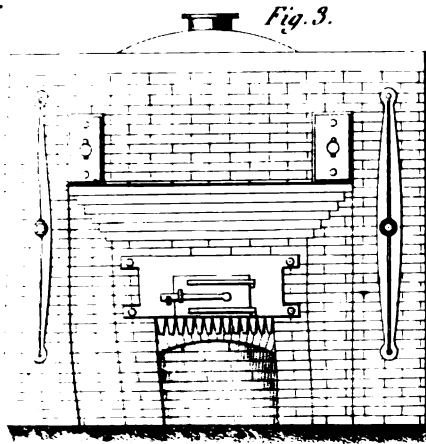
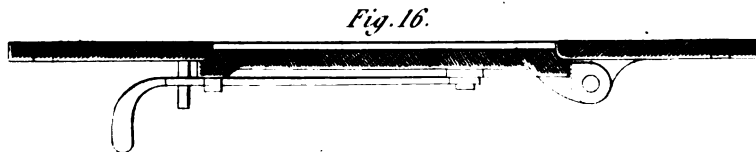
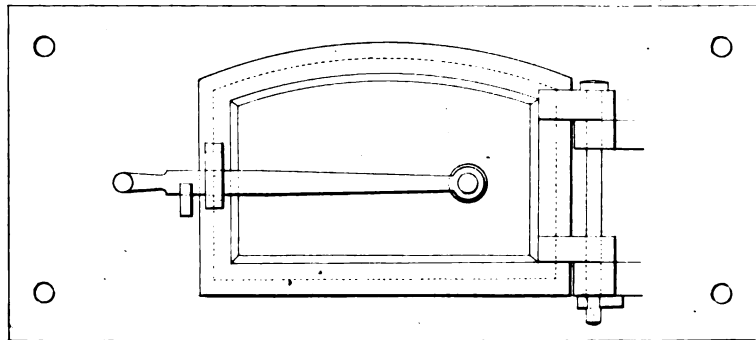


Fig. 15.





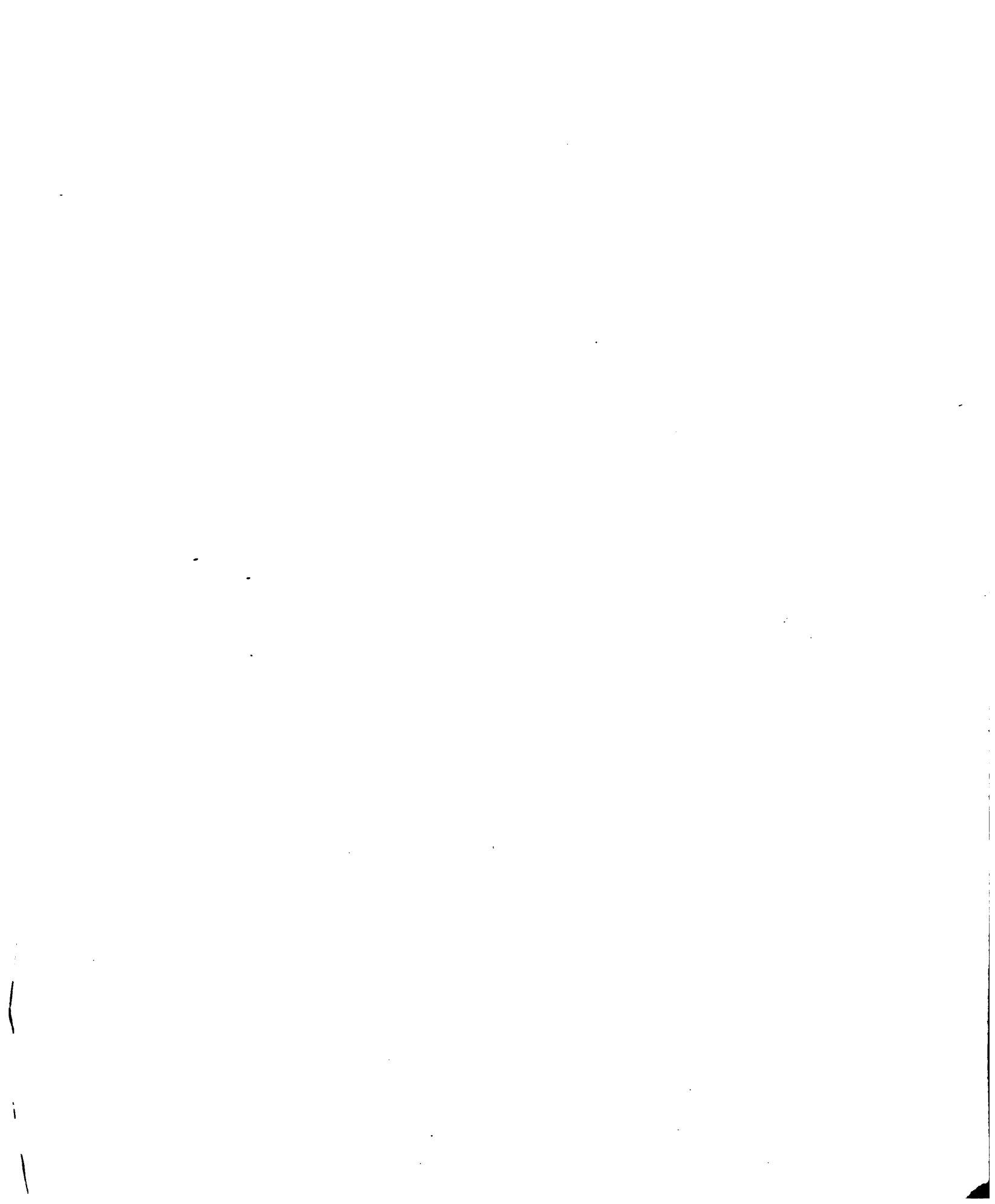


Fig. 1.

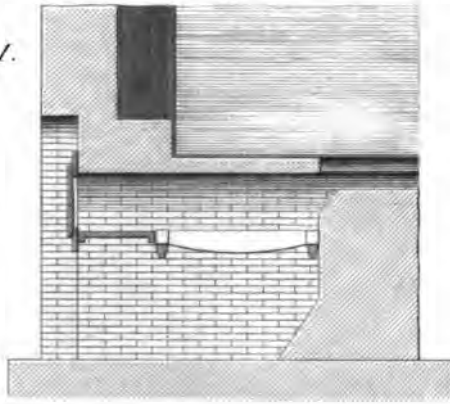


Fig. 3.

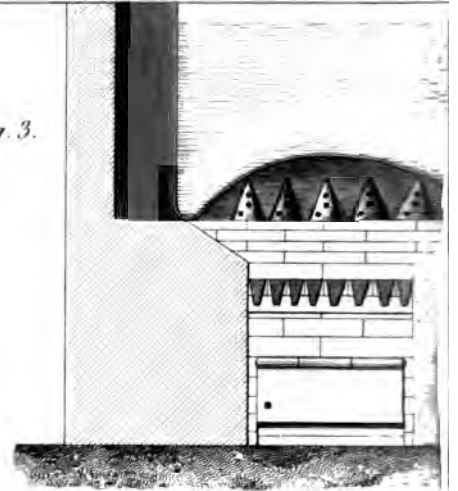


Fig. 2.

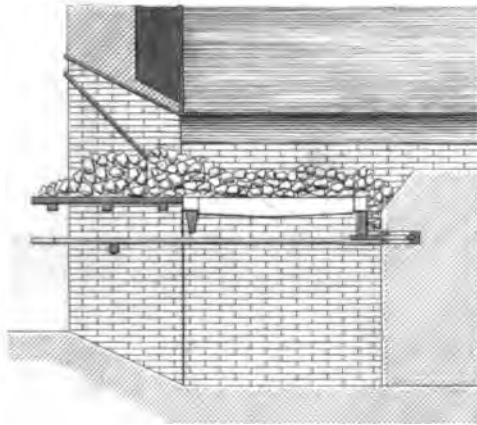


Fig. 5.

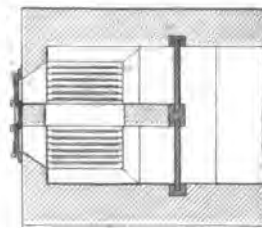
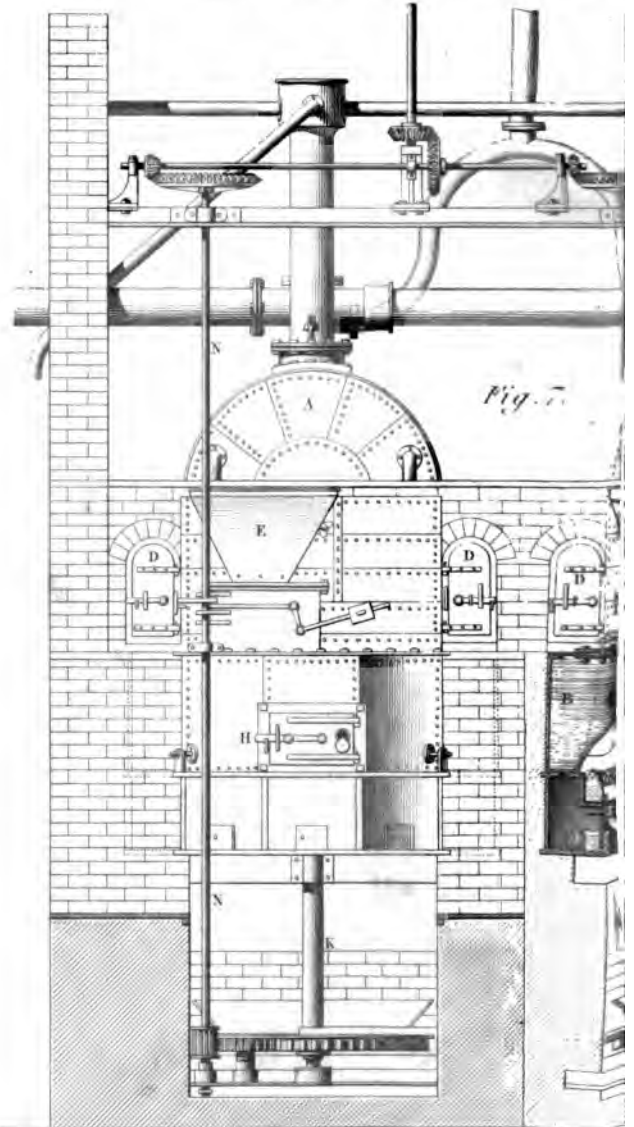
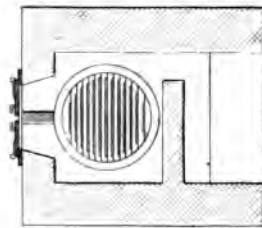
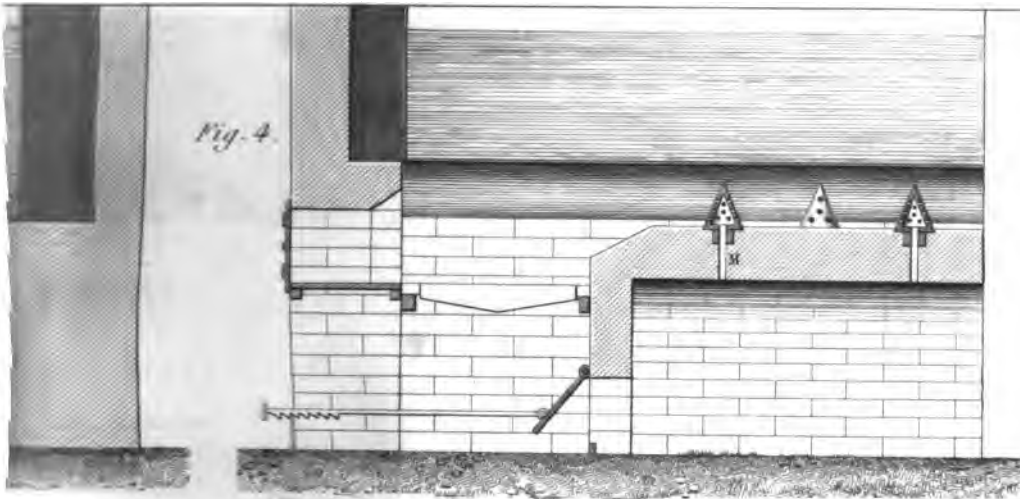
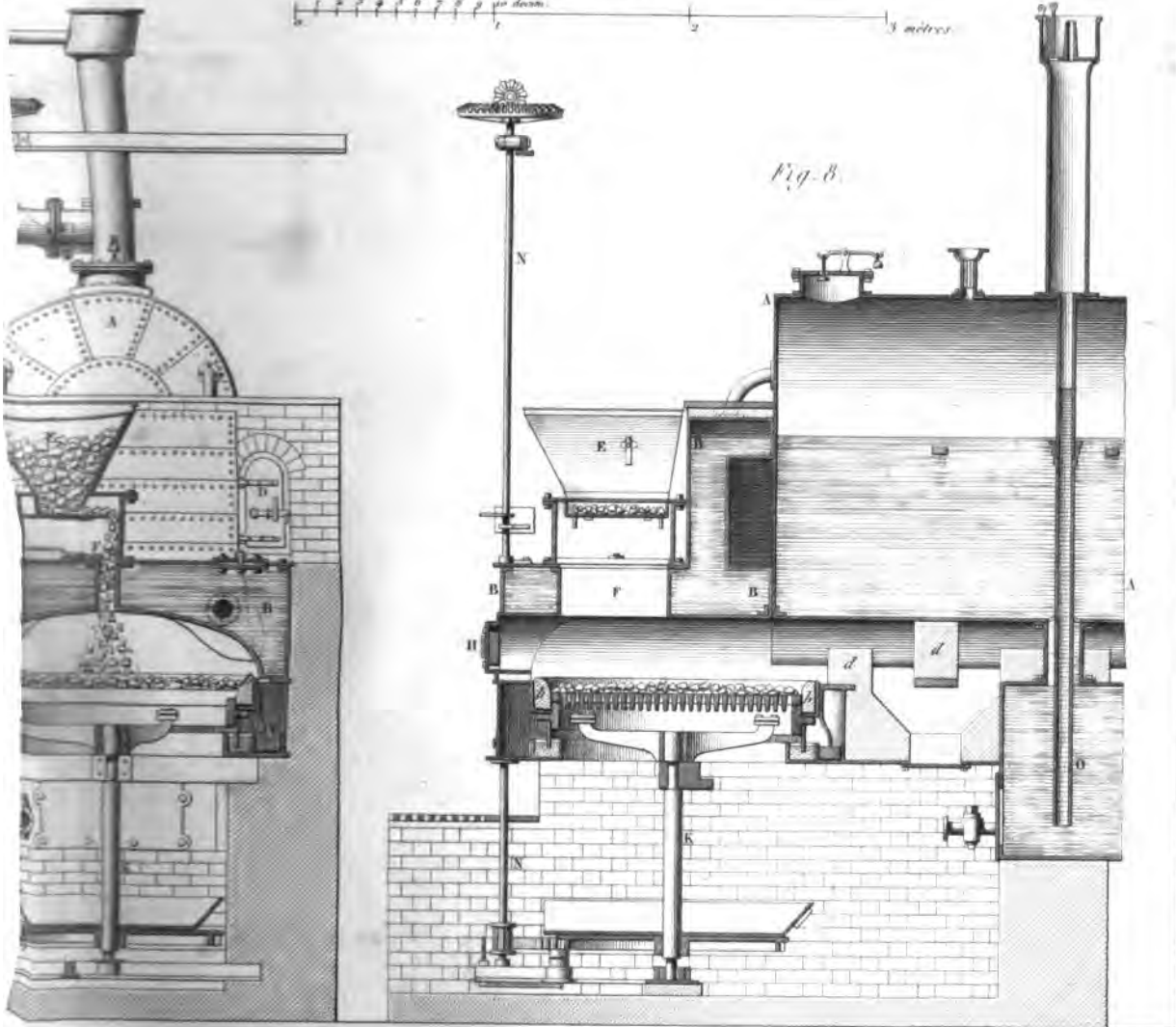


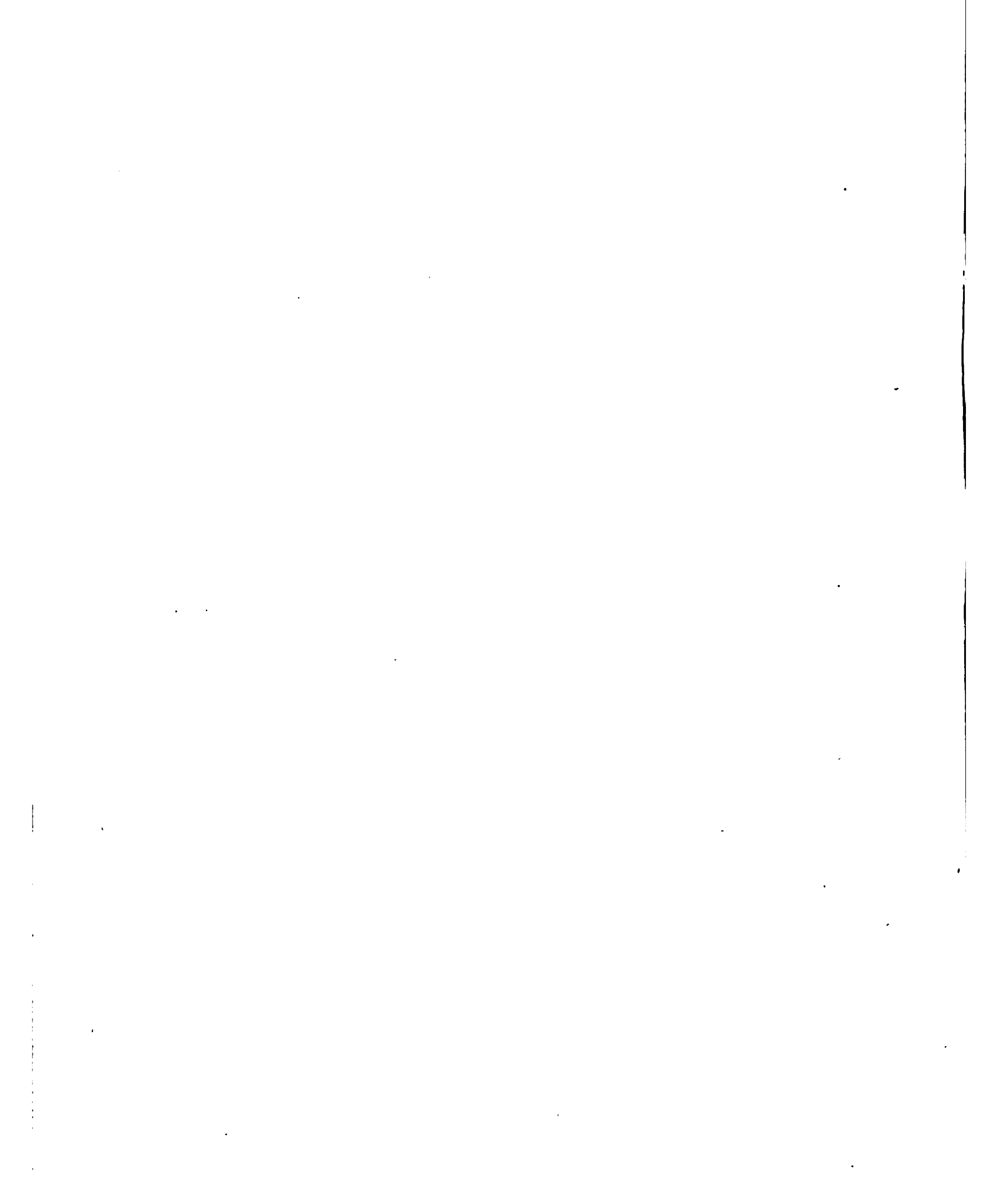
Fig. 6.

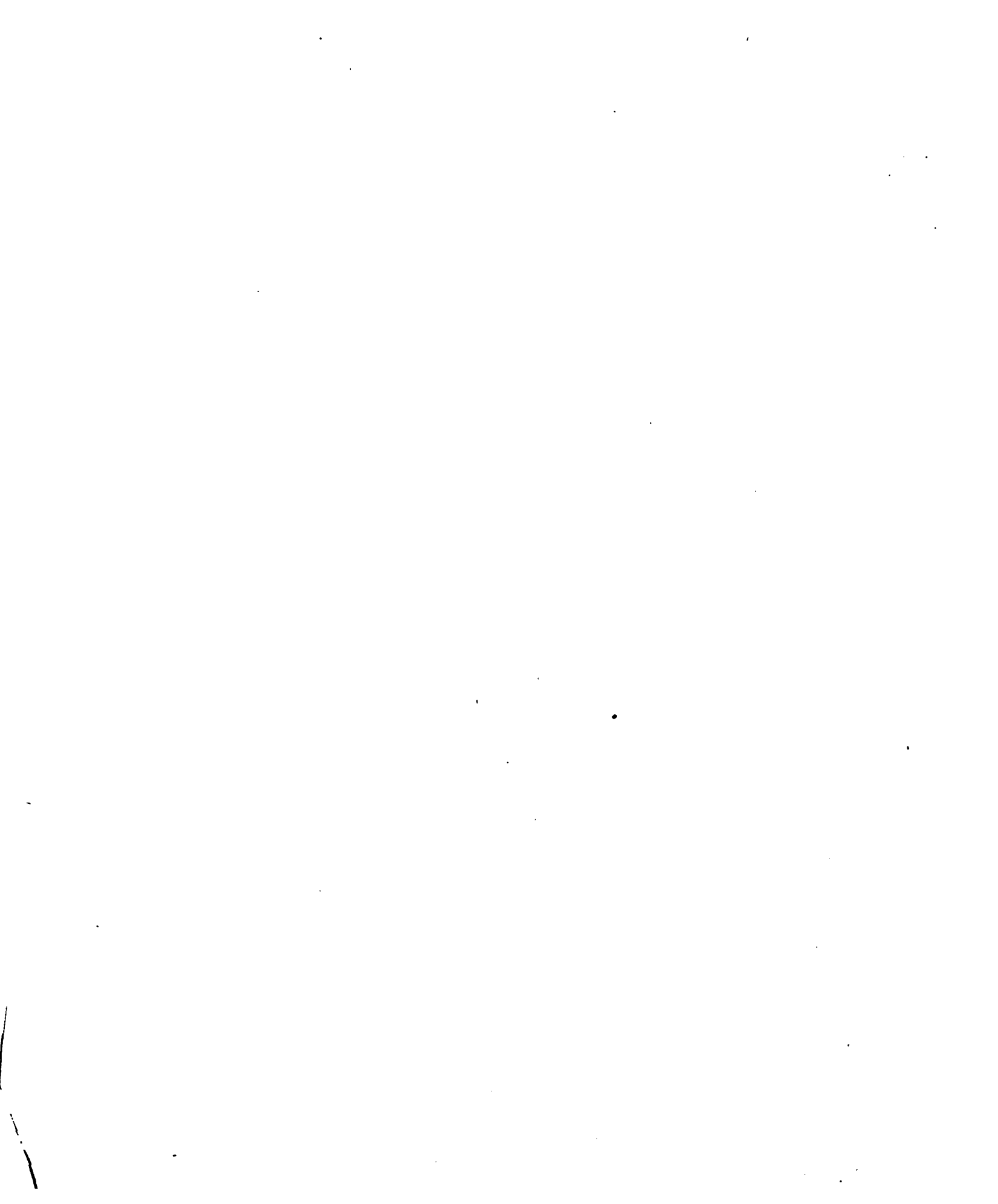




Echelle des Fig 7 et 8.
0 1 2 3 4 5 6 7 8 9 10
100 centim.
1 2 3 mètres







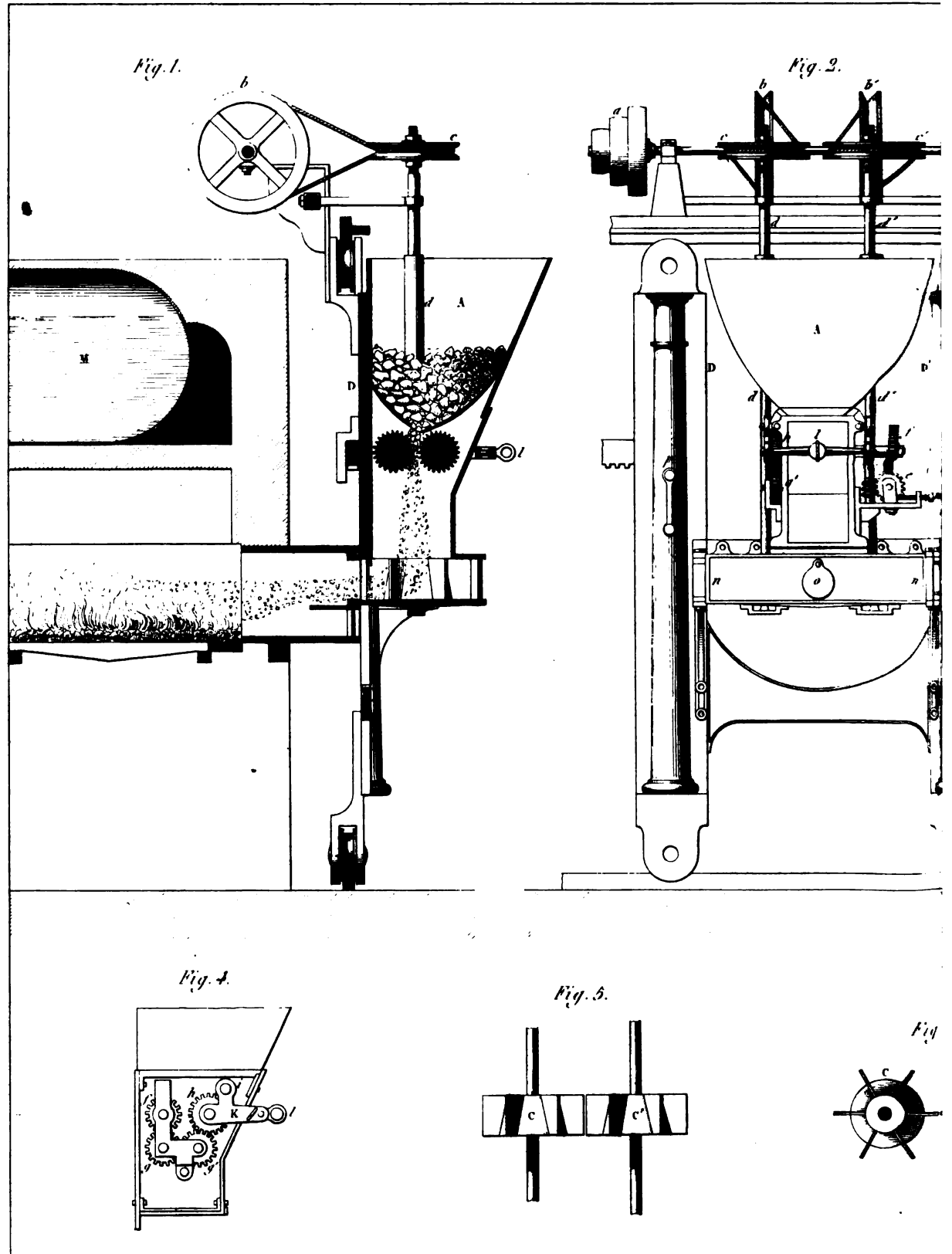


Fig. 3.

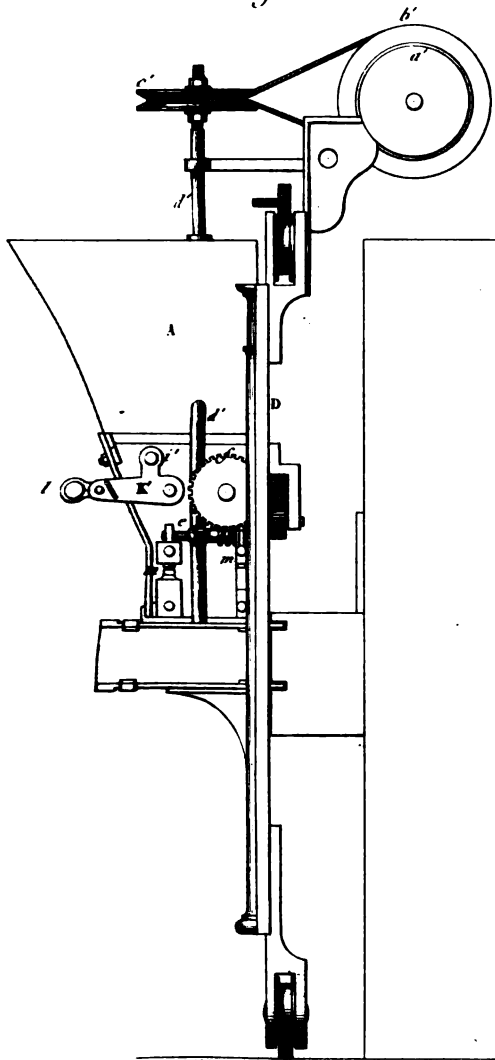
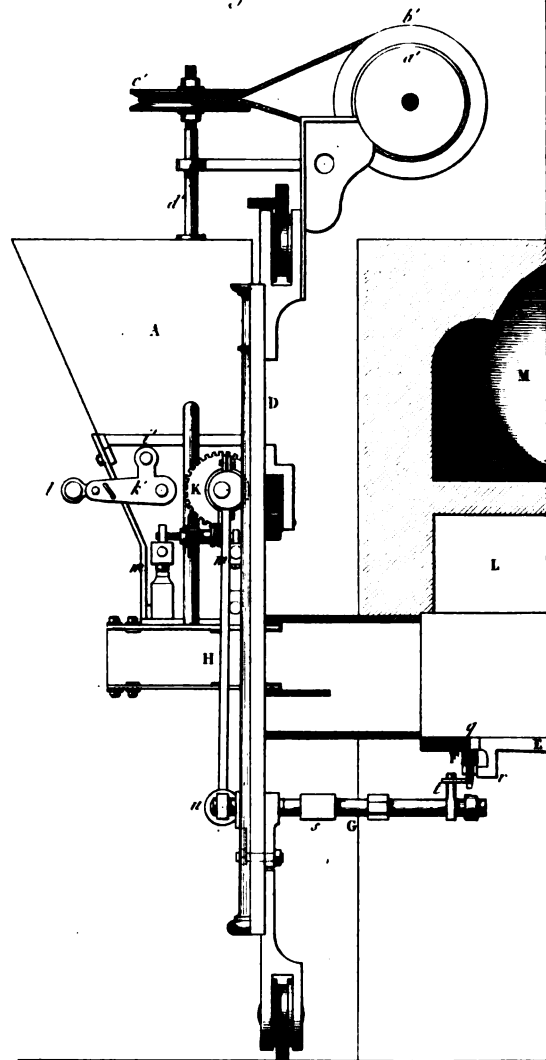
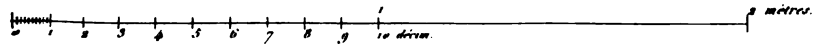
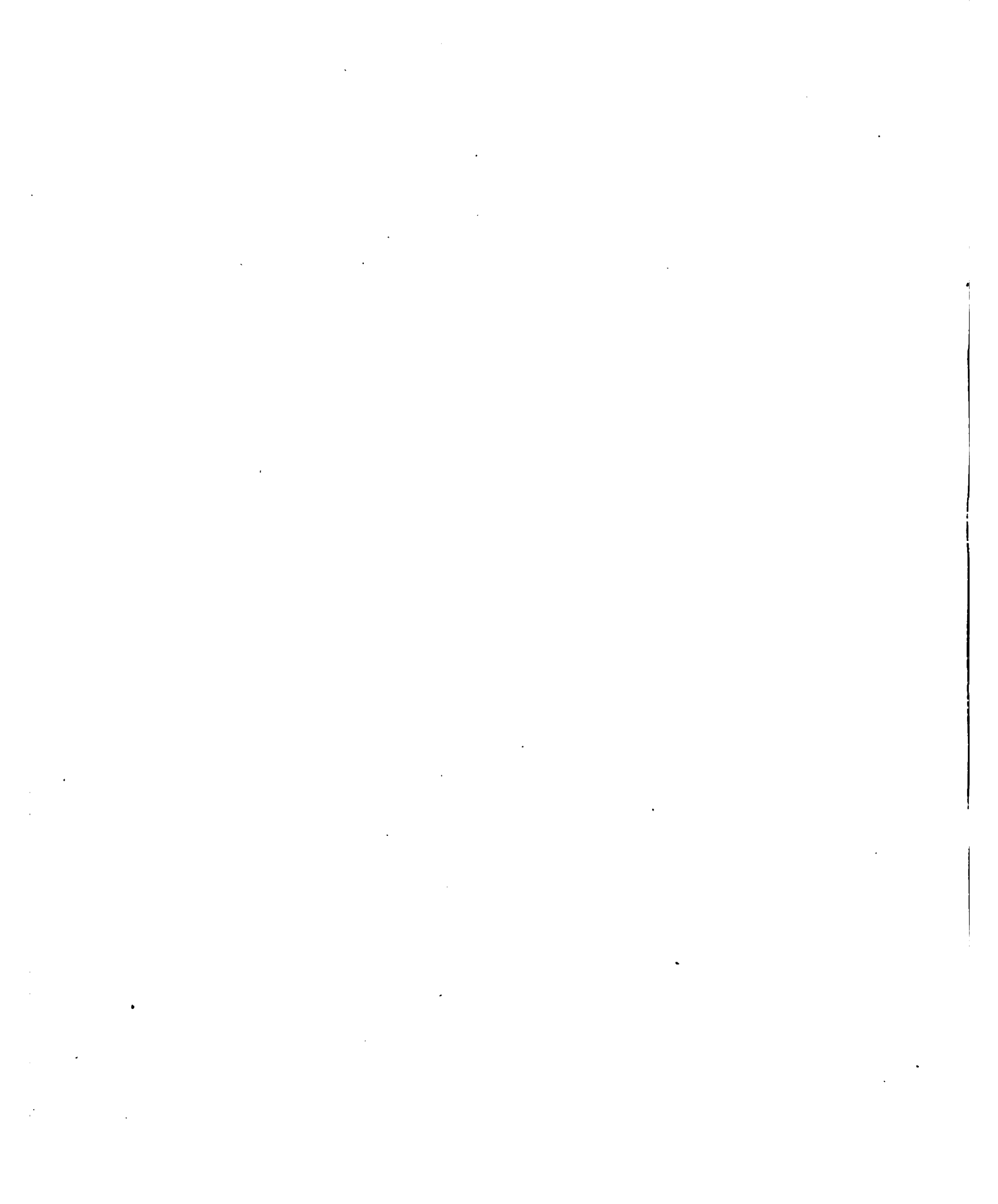


Fig. 8.



Echelle.





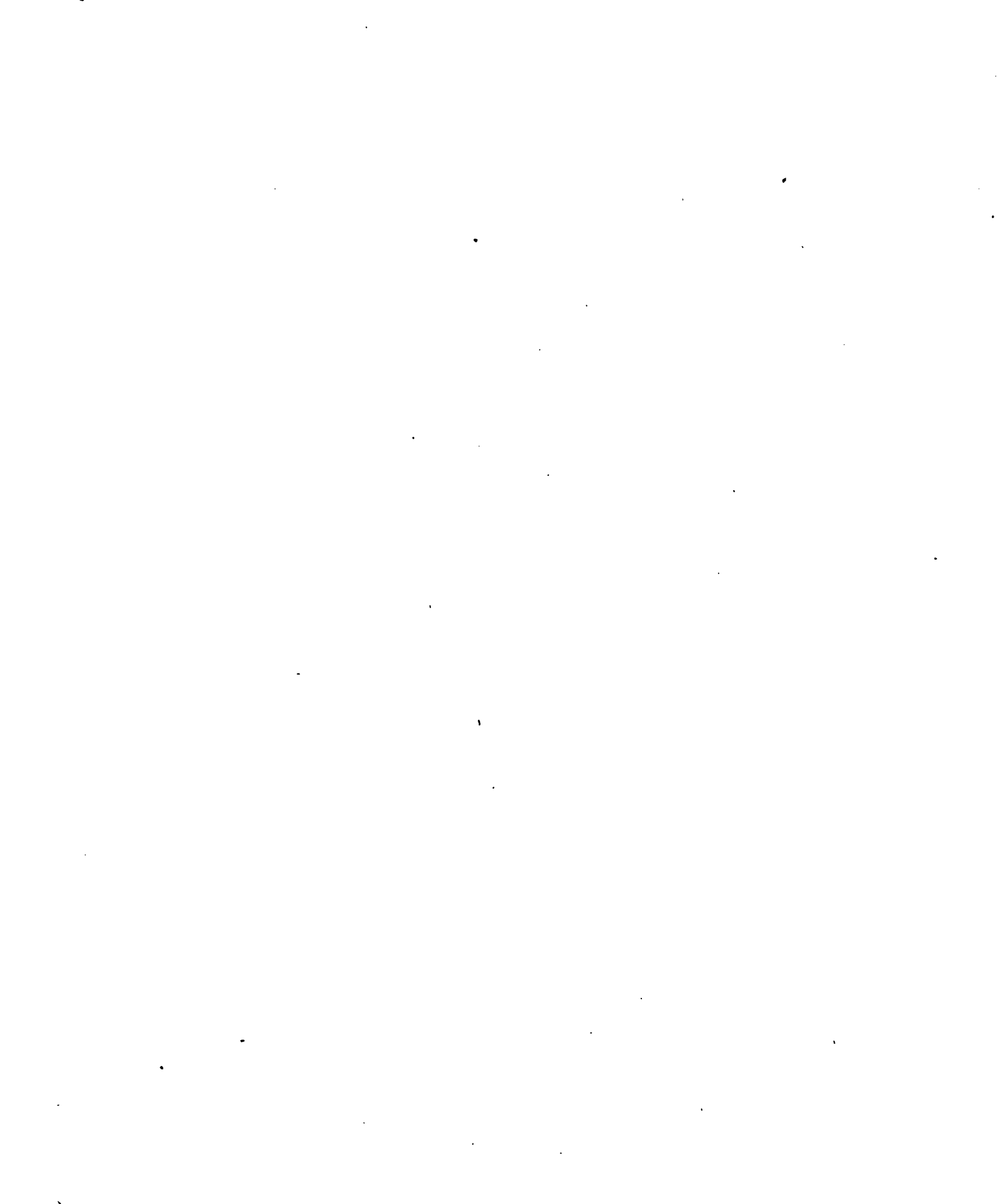


Fig. 1.

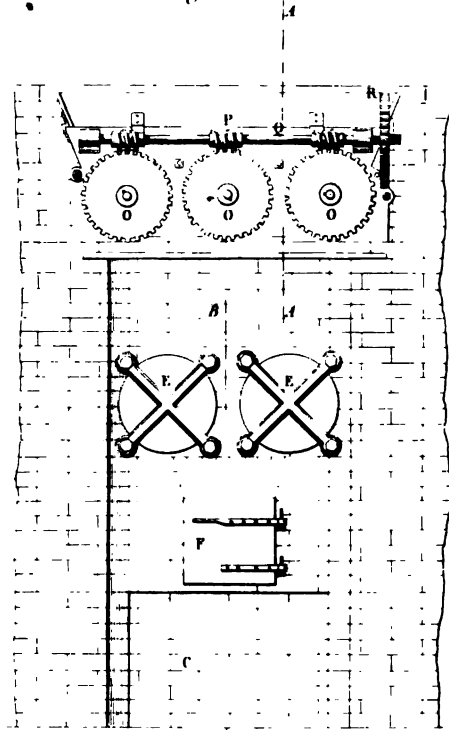
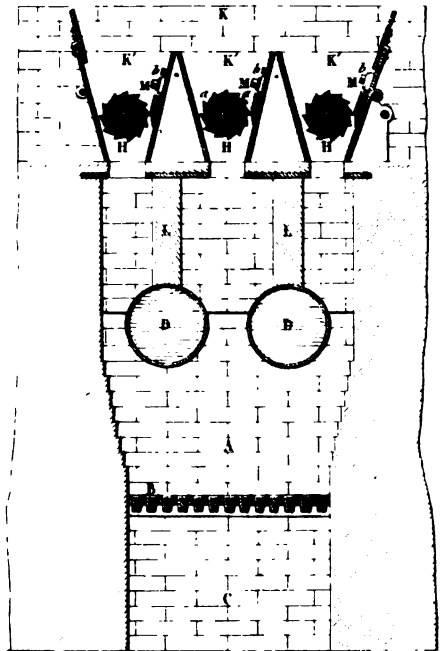


Fig. 2.



B

Echelle des Fig. 1, 2 et 3.

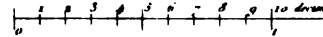


Fig. 11.

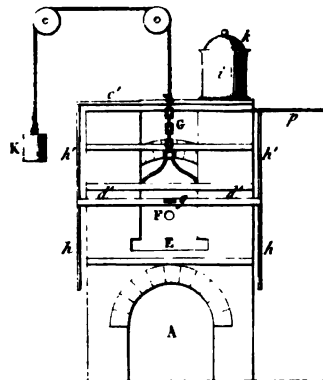


Fig. 10.

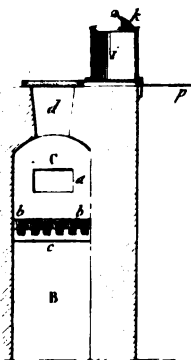
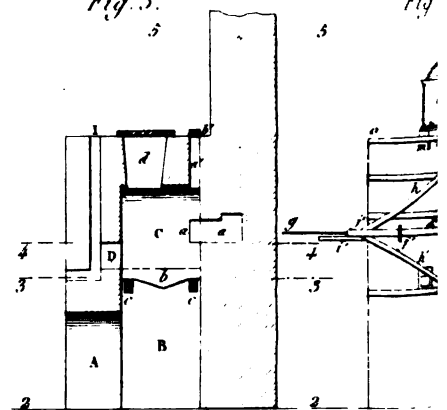


Fig. 3.



Echelle des Fig. 6, 7, 8, 9, 10, 11 et 12.

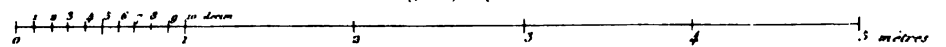


Fig. 3.

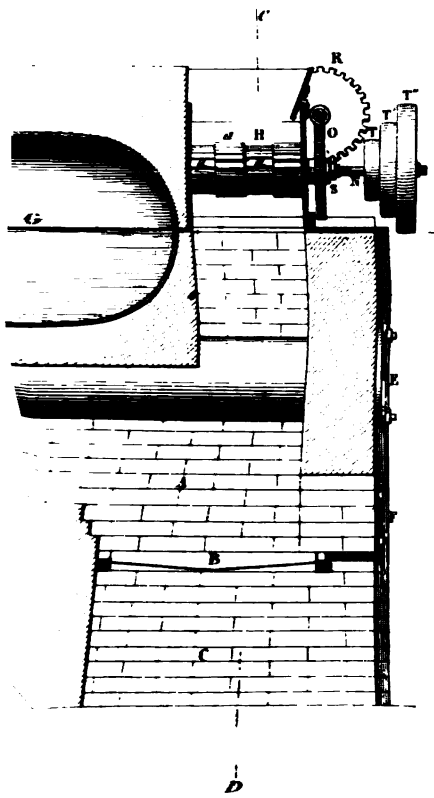


Fig. 4.

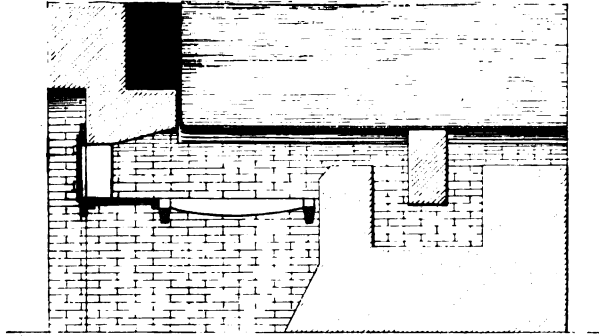


Fig. 14.

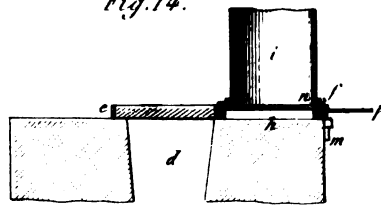


Fig. 15.

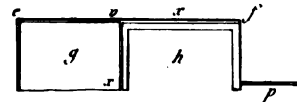


Fig. 13.



Fig. 6.

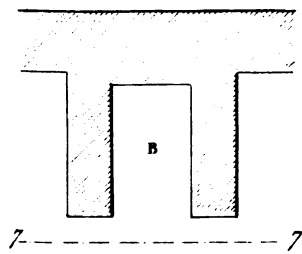


Fig. 7.

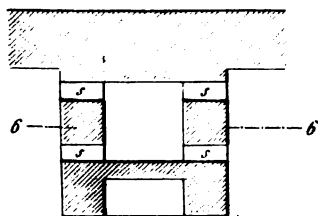


Fig. 8.

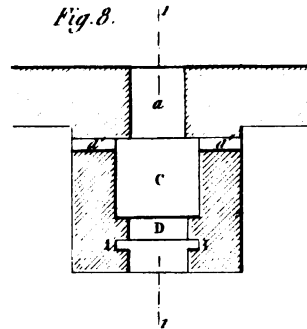
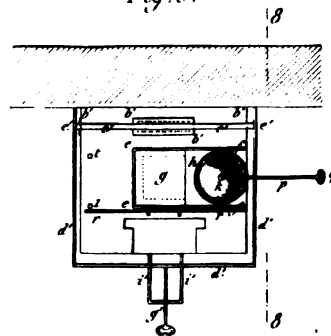
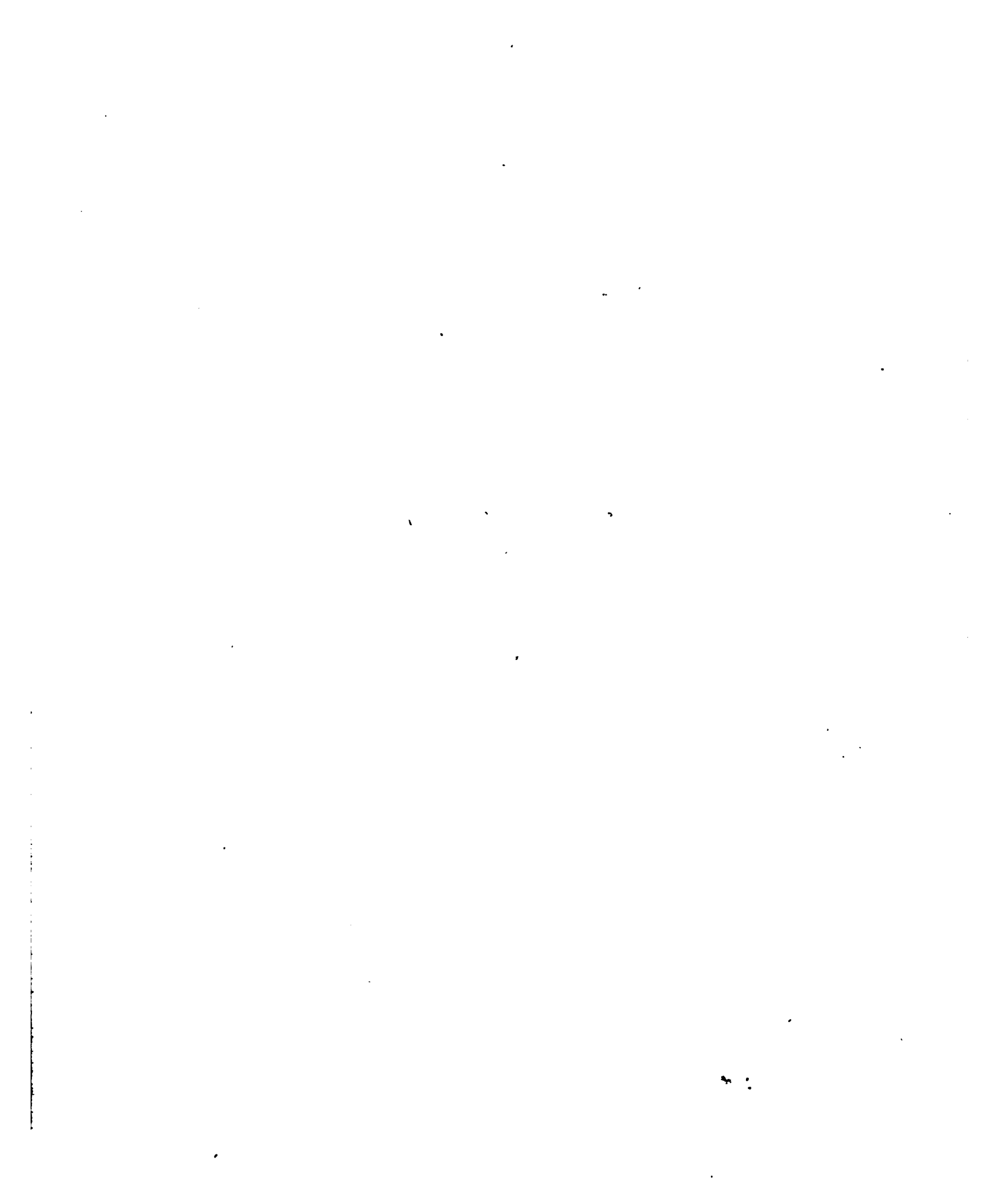
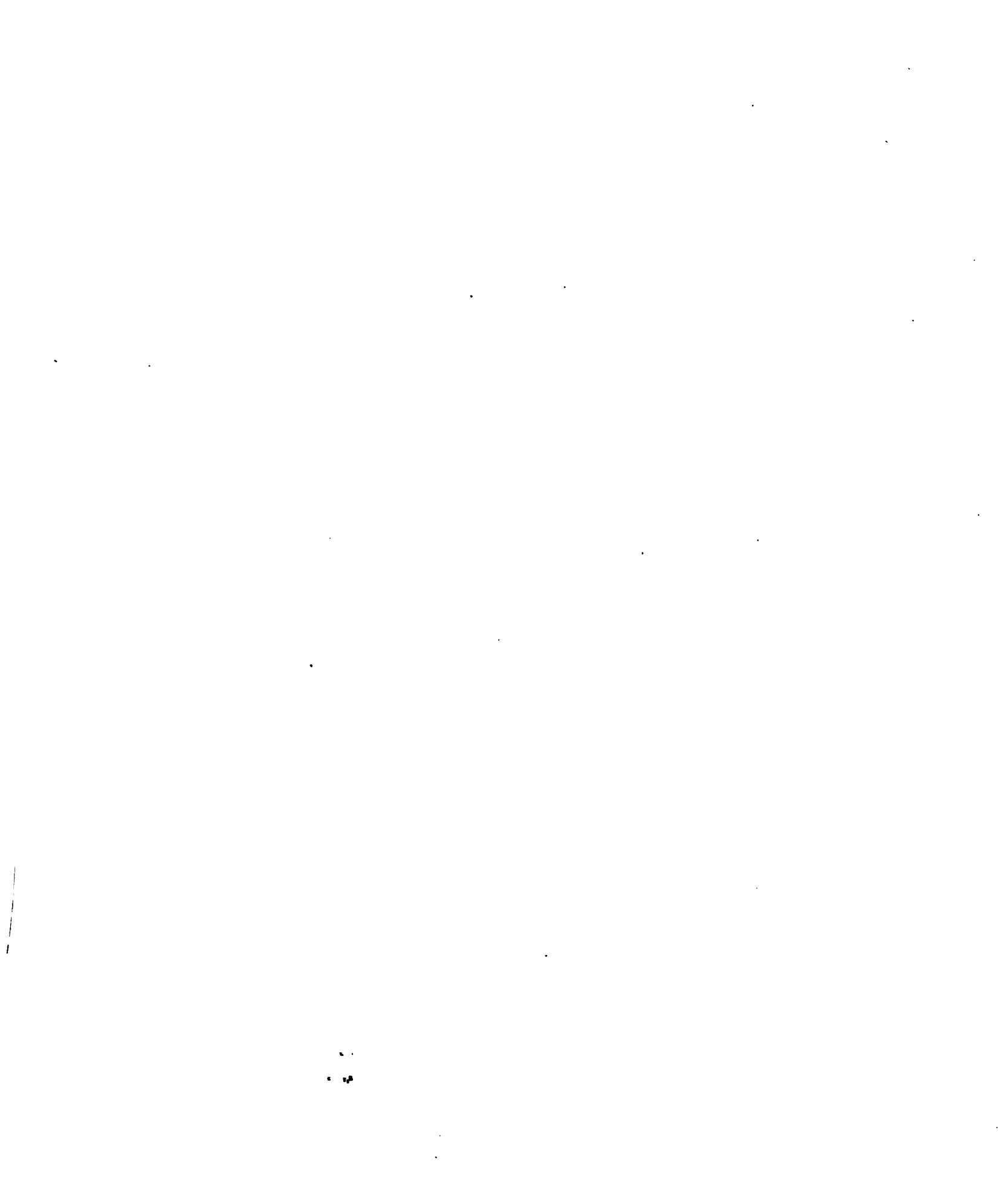


Fig. 9.







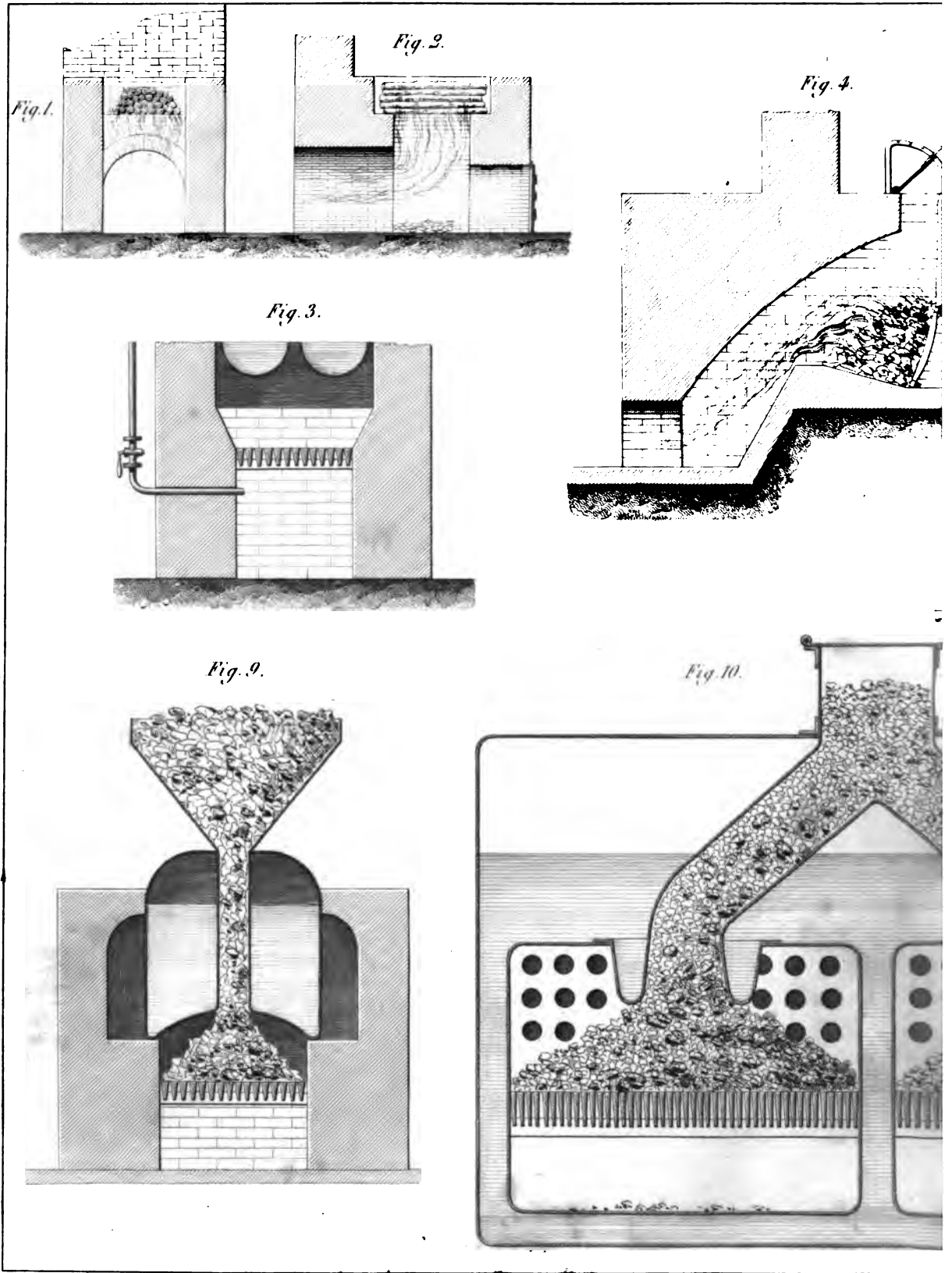


Fig. 5.

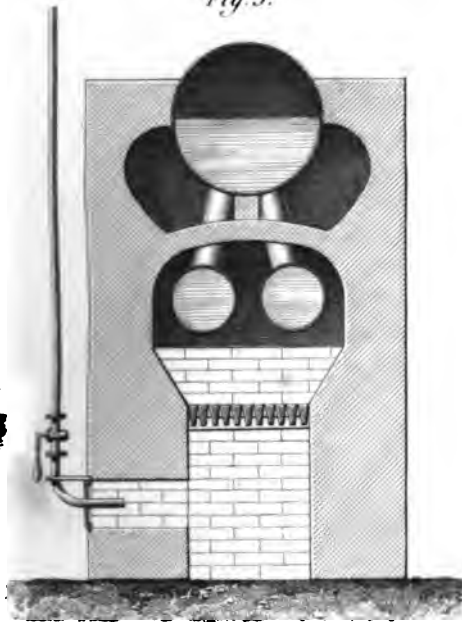


Fig. 7.

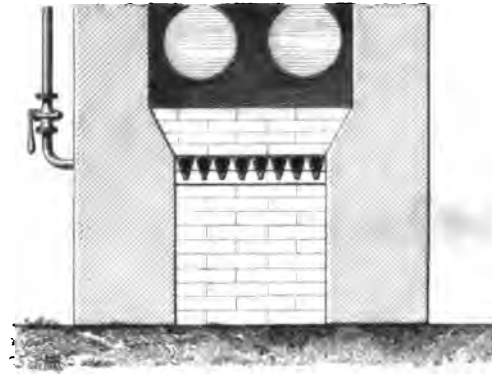


Fig. 6.

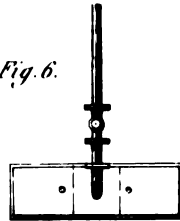
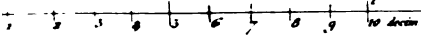


Fig. 8.

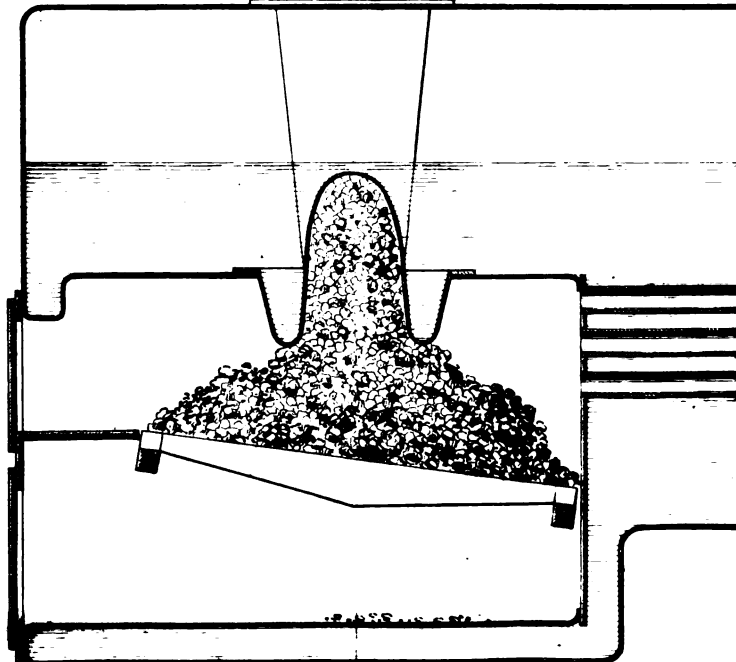
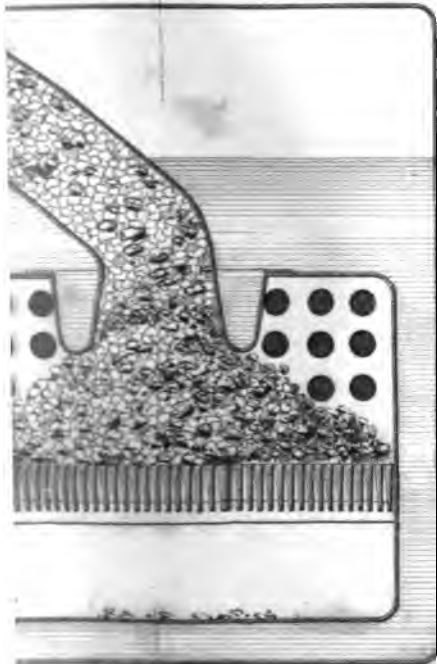
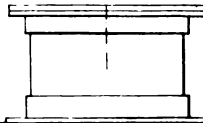


Echelle des Fig. 10 à 12.



3 mètres

Fig. 11.



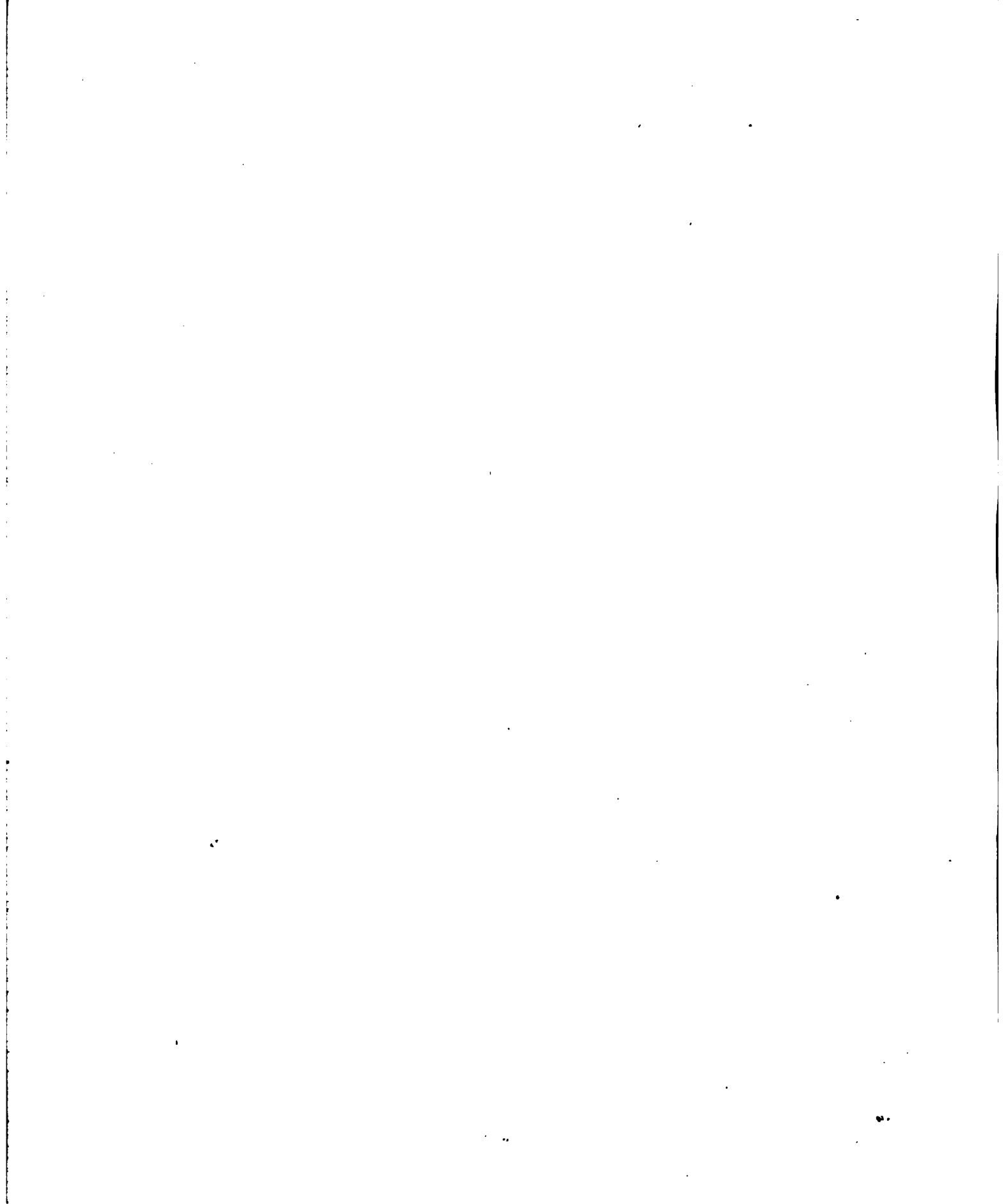
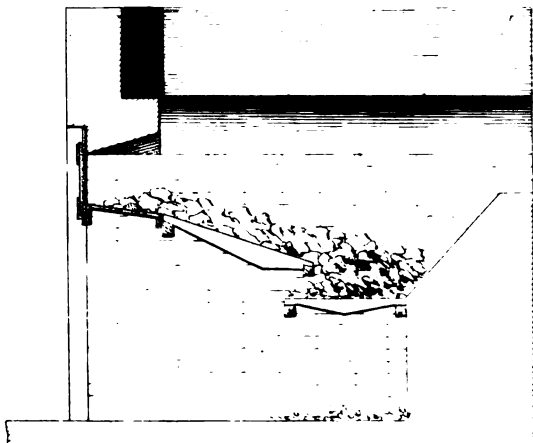




Fig. 1.



Echelle de la Fig. 1.

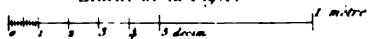


Fig. 2.

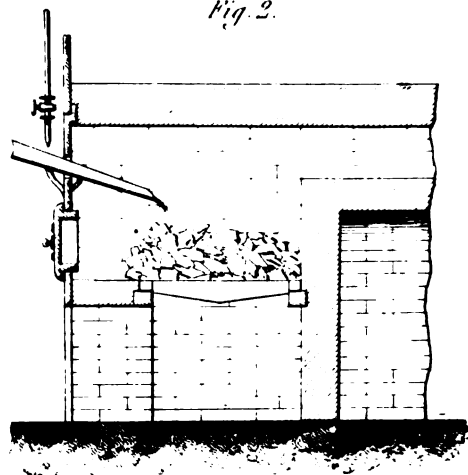


Fig. 7.

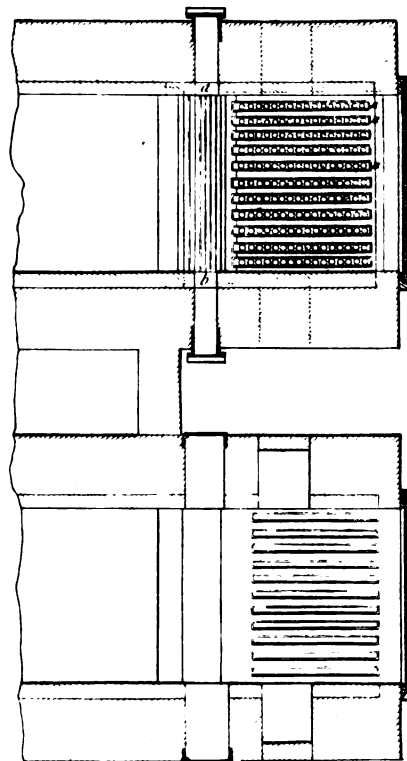


Fig. 8.

Echelle des Fig. 6, 7, 8, 9 et 10.

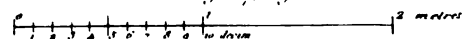


Fig. 5.

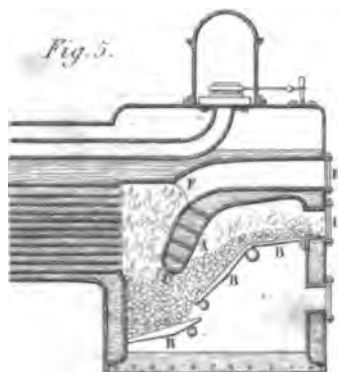


Fig. 6.

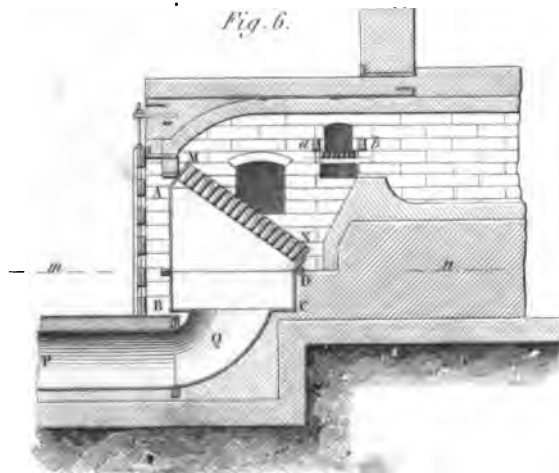


Fig. 3.

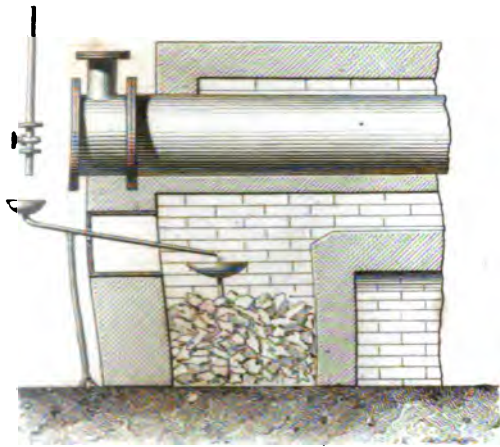


Fig. 4.

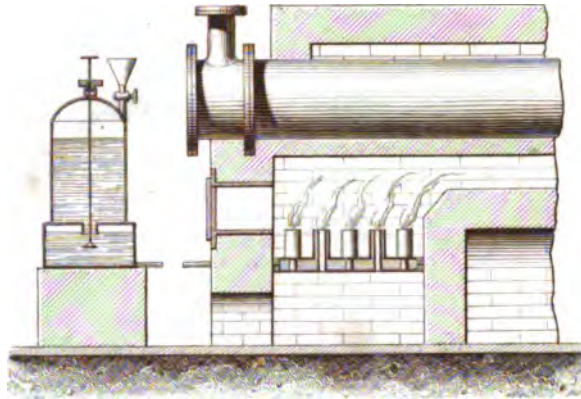


Fig. 9.

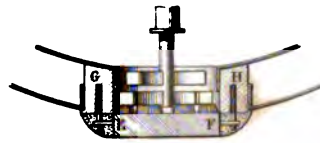
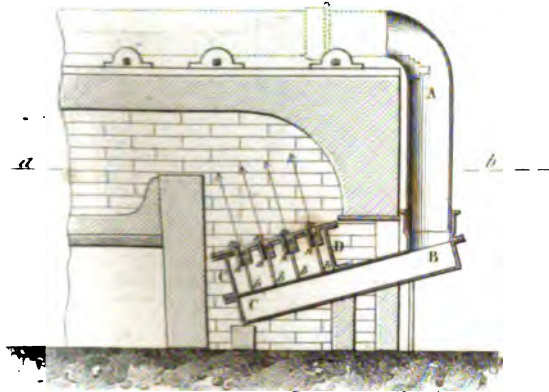
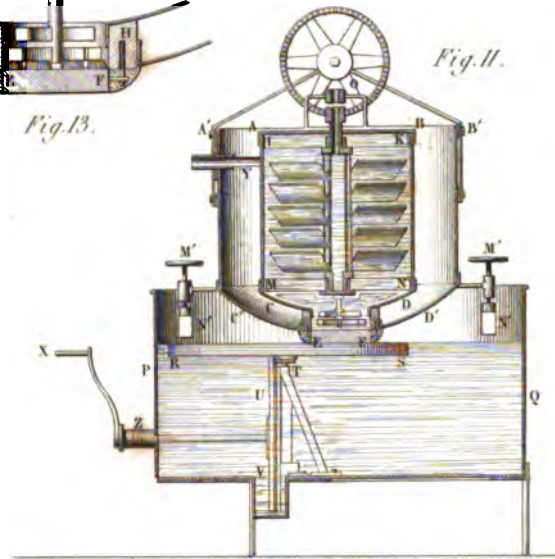


Fig. 13.

Fig. 11.



Echelle des Fig. 11 et 12.

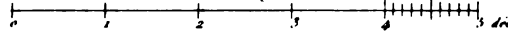


Fig. 10.

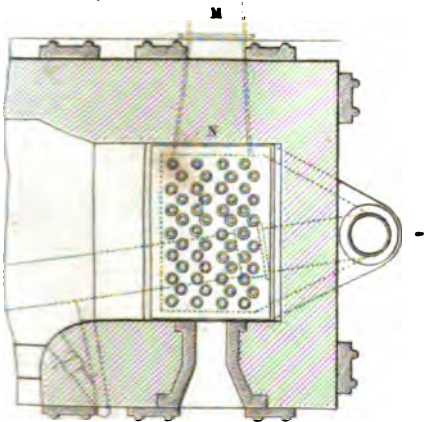
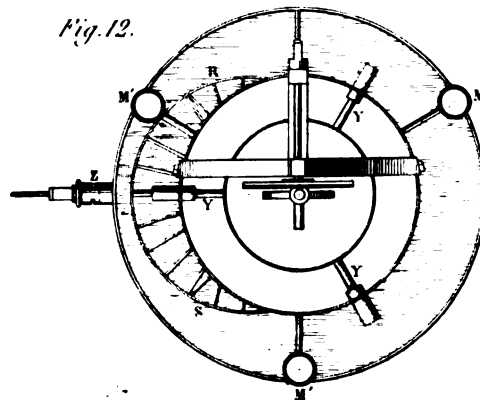


Fig. 12.



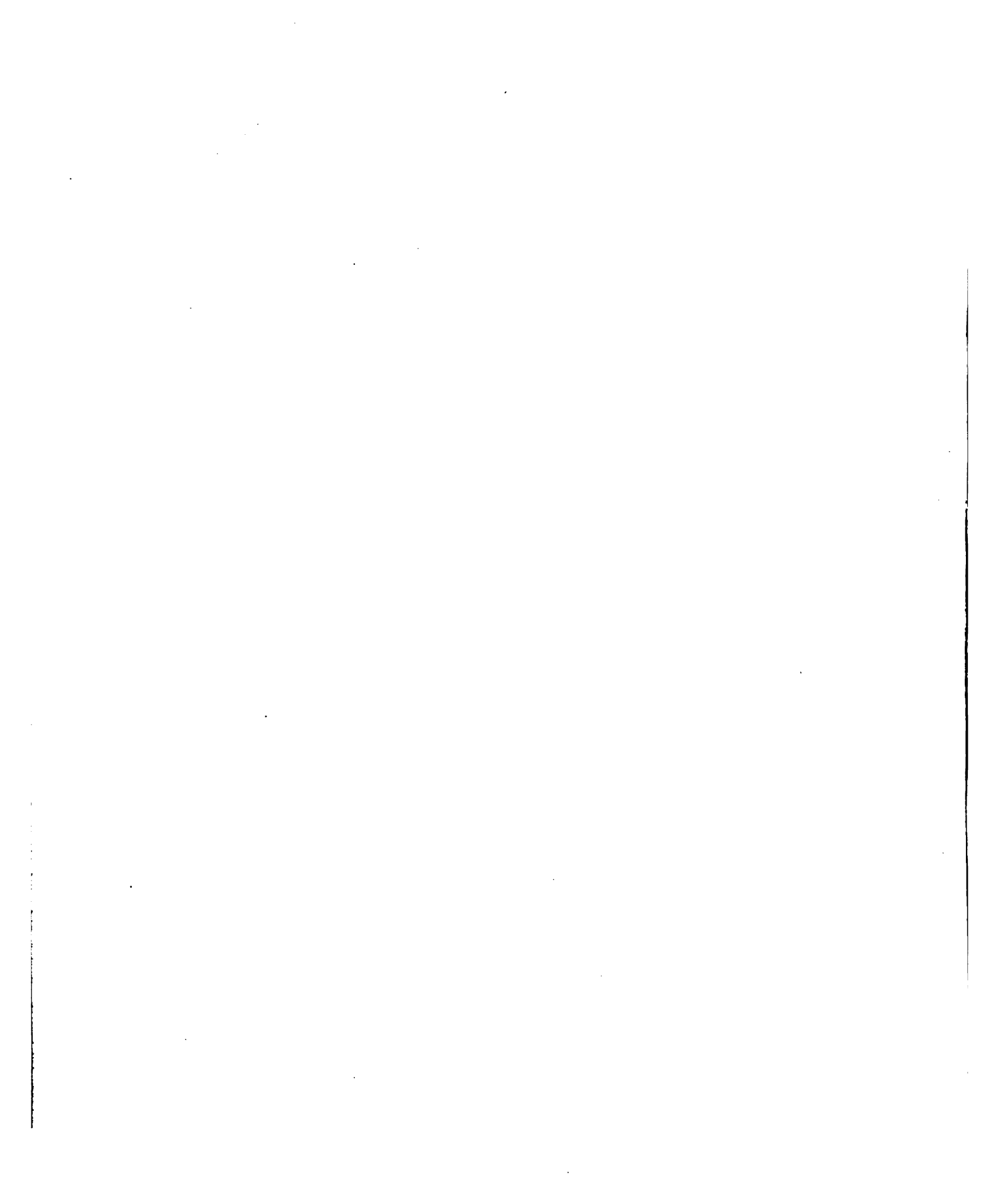




Fig. 1.

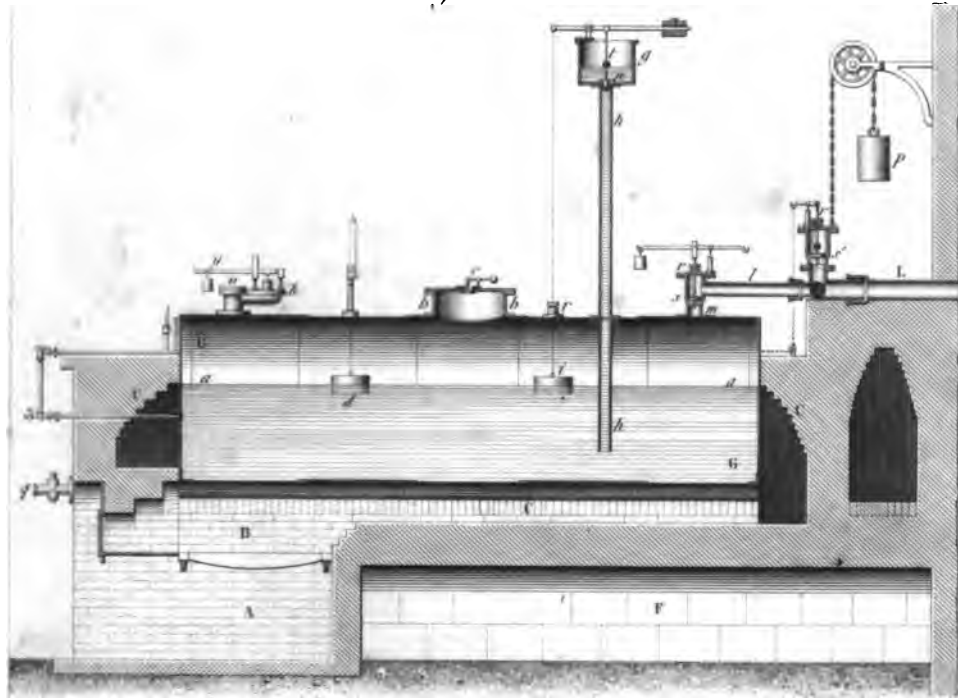
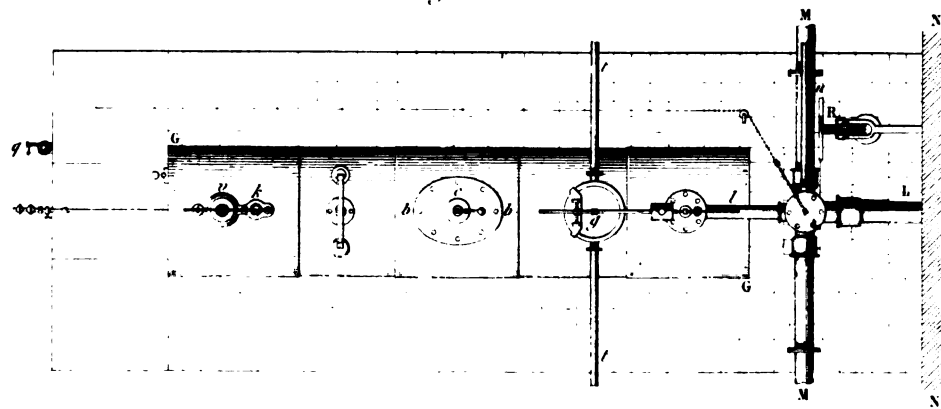


Fig. 2.



Echelle des Fig. 1, 2 et 3.



Fig. 4.

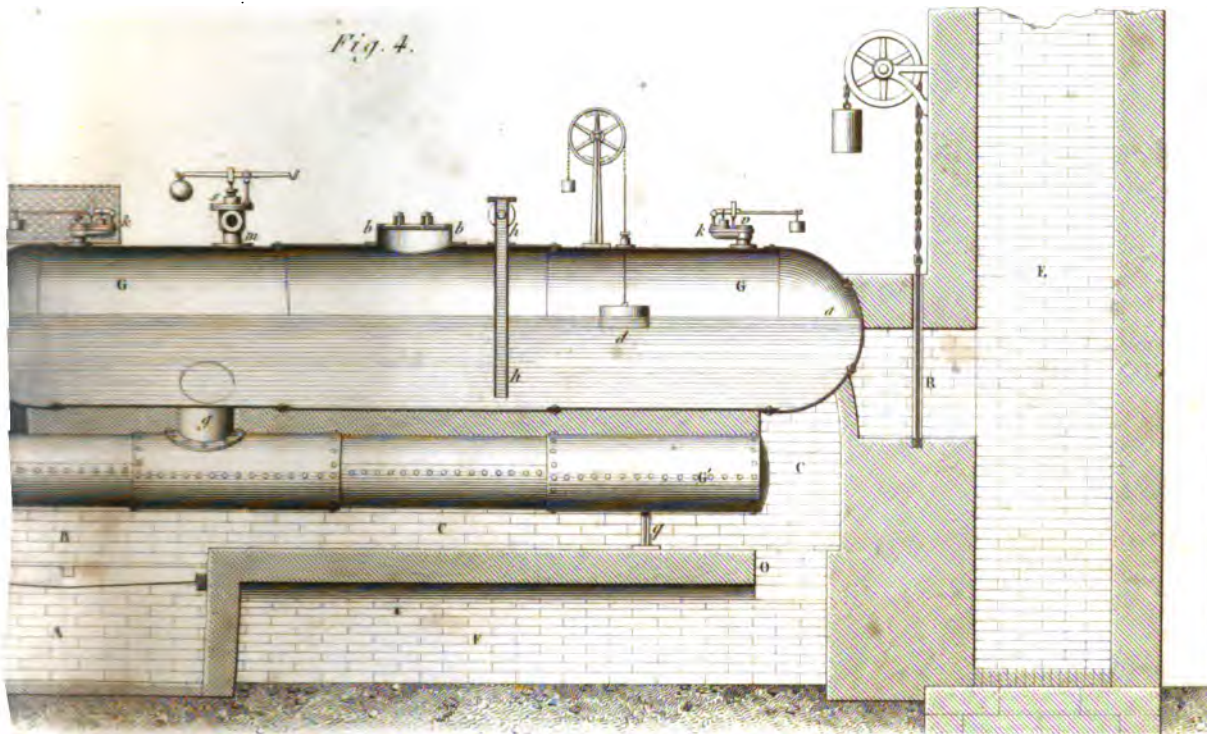


Fig. 5.

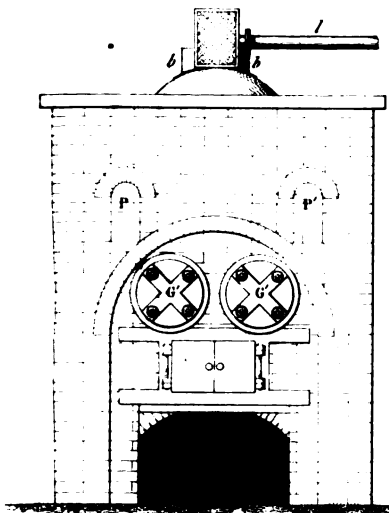


Fig. 6.

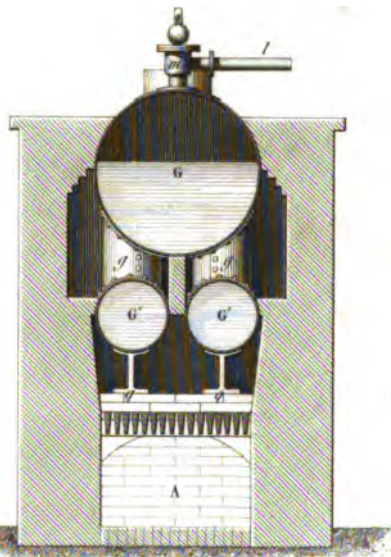
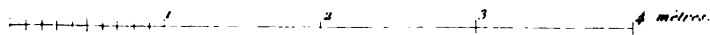
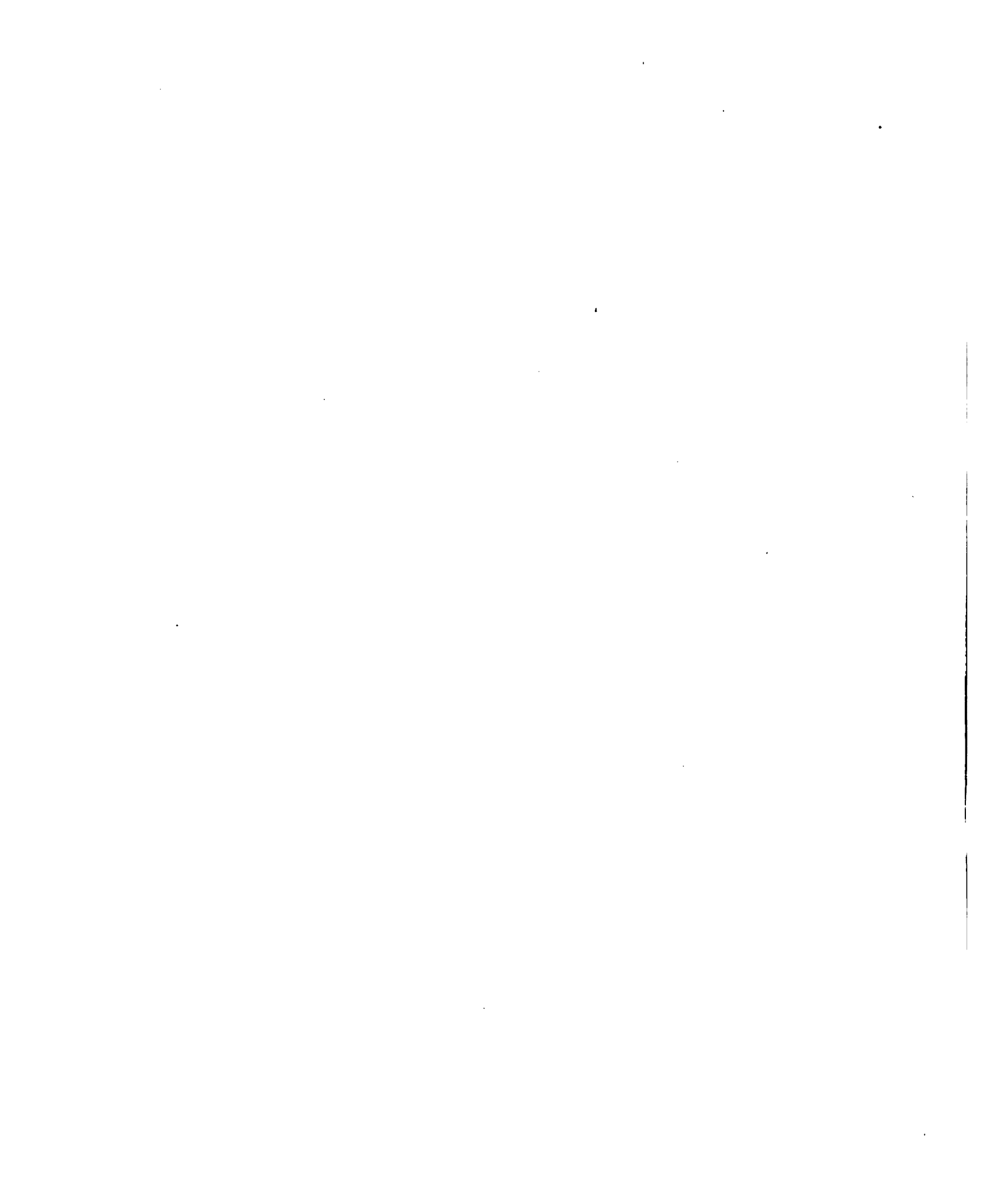


Fig. 3.



Echelle des Fig. 4, 5 et 6.





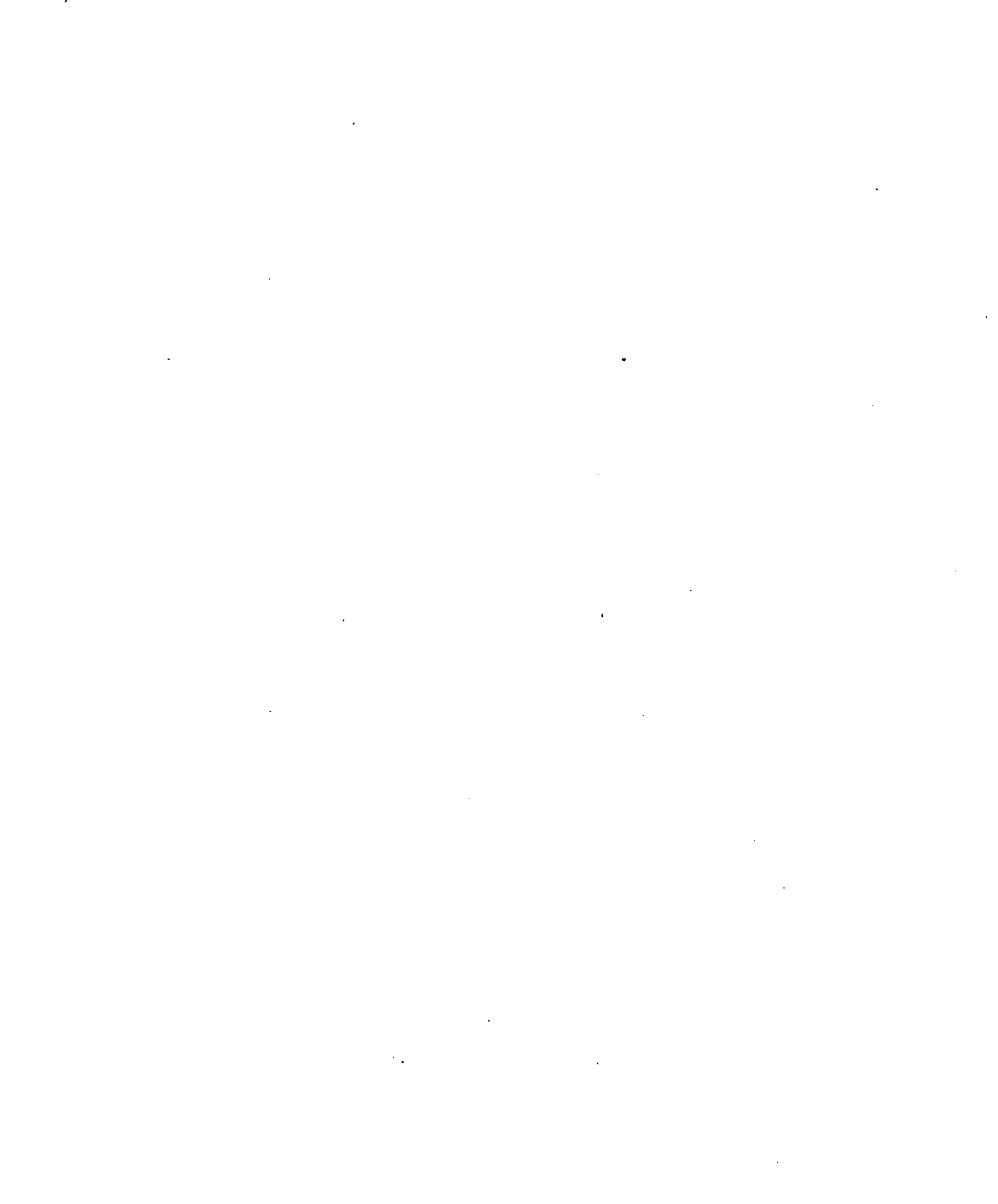


Fig. 1.

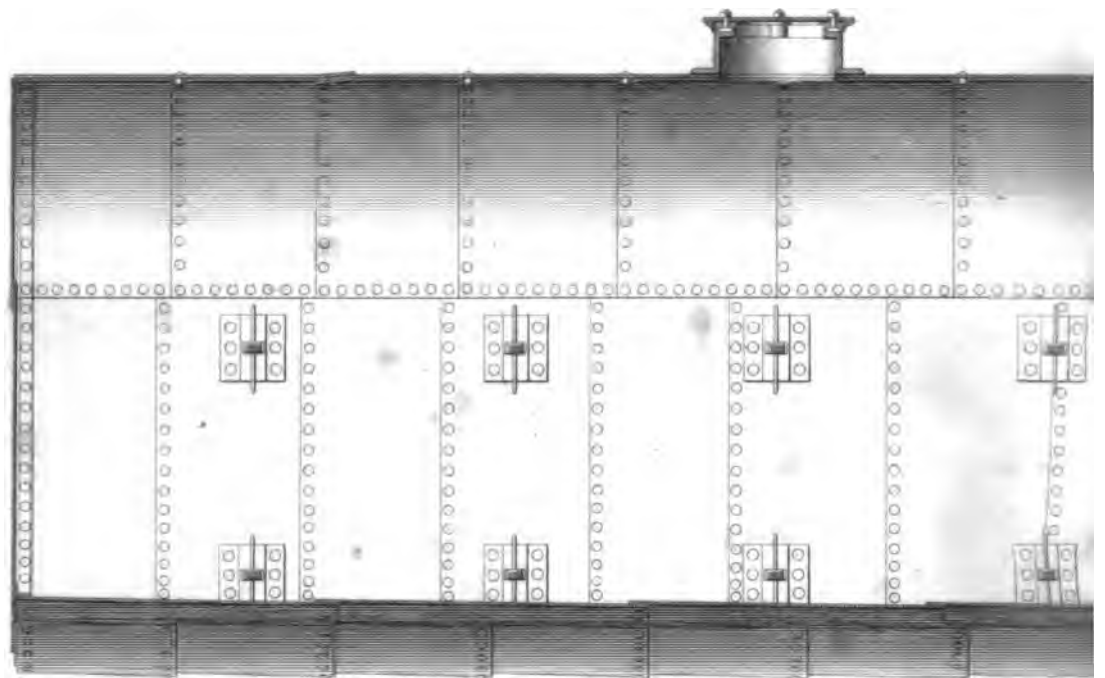


Fig. 8.

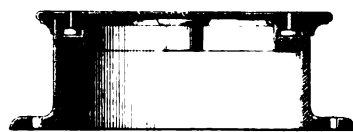


Fig. 12.

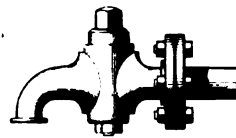


Fig. 10.

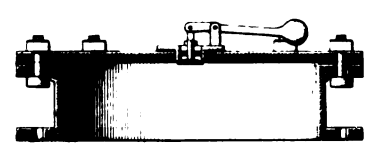


Fig. 9.

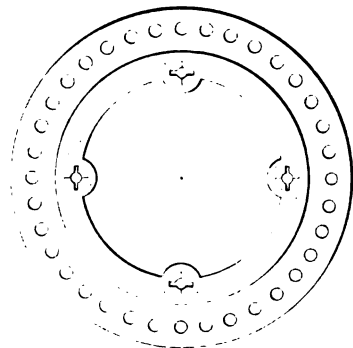


Fig. 13.

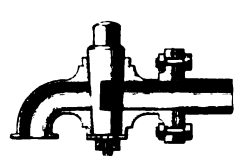
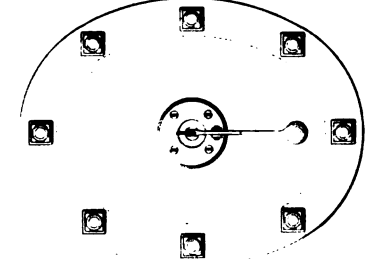
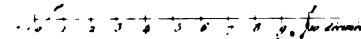


Fig. 11.



Echelle des Fig. 1, 2, 3 et 4



2 mètres

Fig. 2.

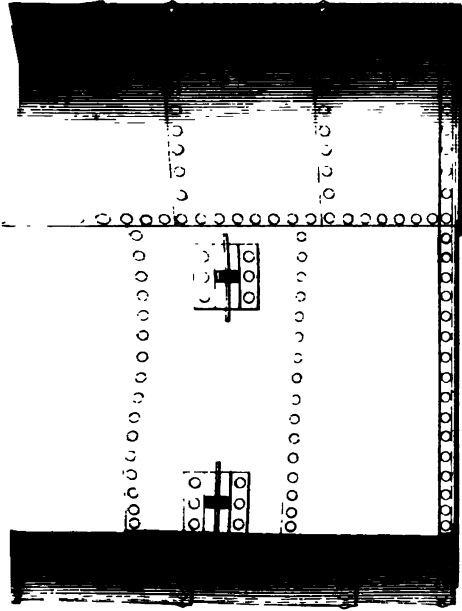
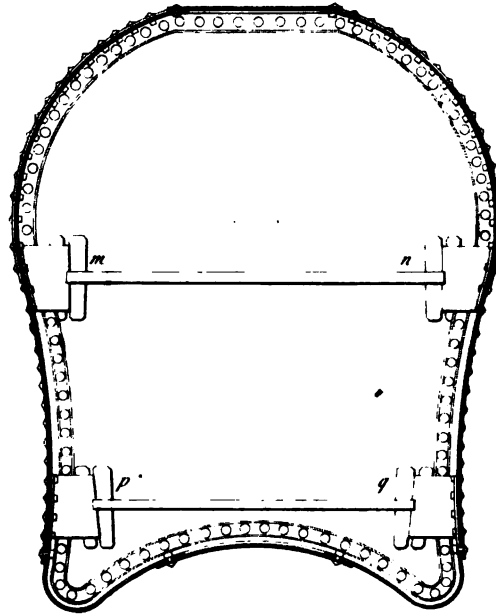


Fig. 5.

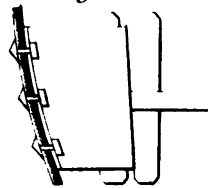


Fig. 6.

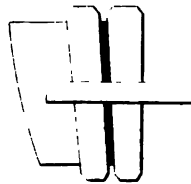


Fig. 7.

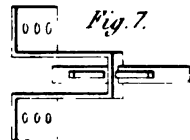


Fig. 4.

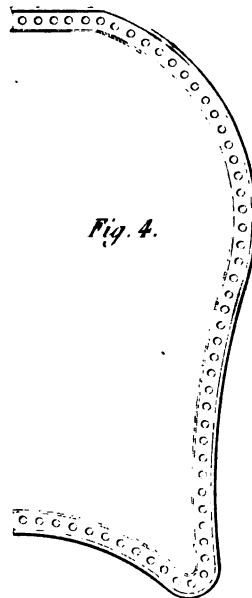


Fig. 14.

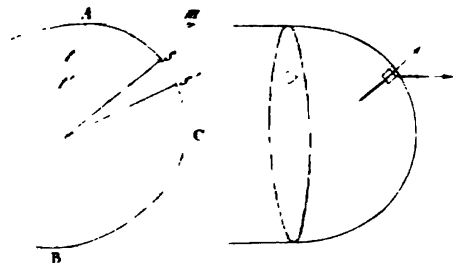


Fig. 15.

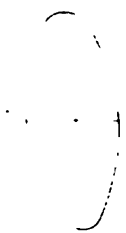


Fig. 3.



Echelle des Fig. 5, 6, 7 et 13.

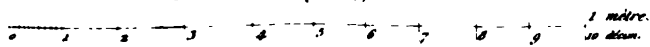


Fig. 1.

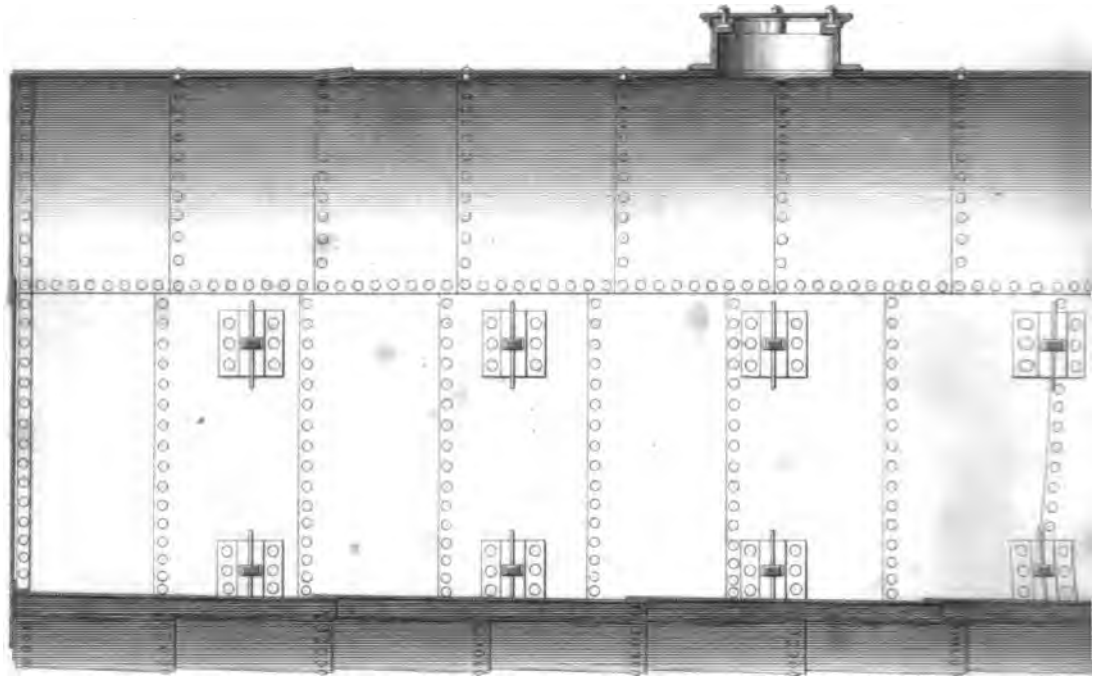


Fig. 8.



Fig. 12.

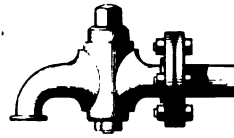


Fig. 10.

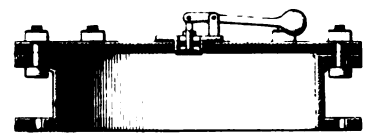


Fig. 9.

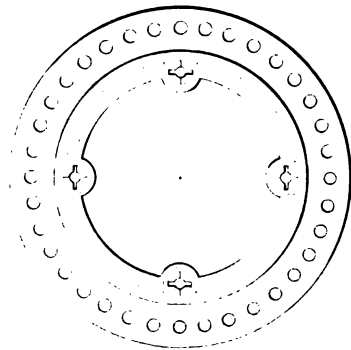


Fig. 13.

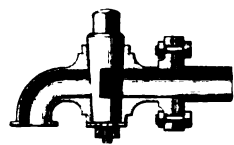
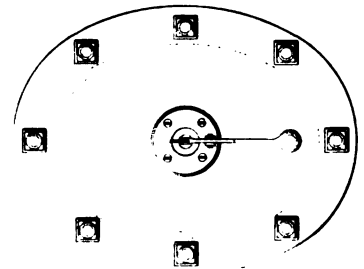
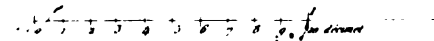


Fig. 11.



Echelle des Fig. 1, 2, 3 et 4.



2 mètres

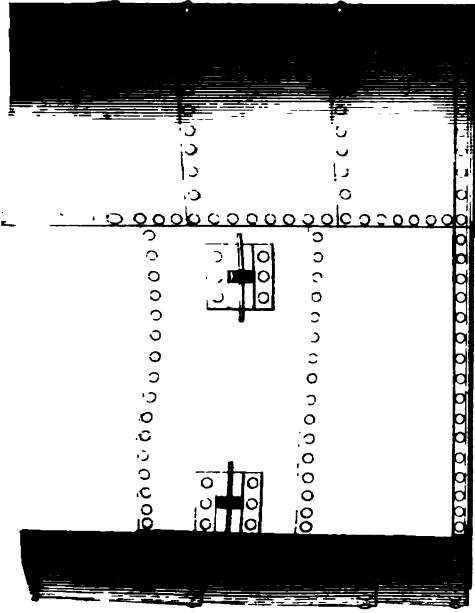


Fig. 2.

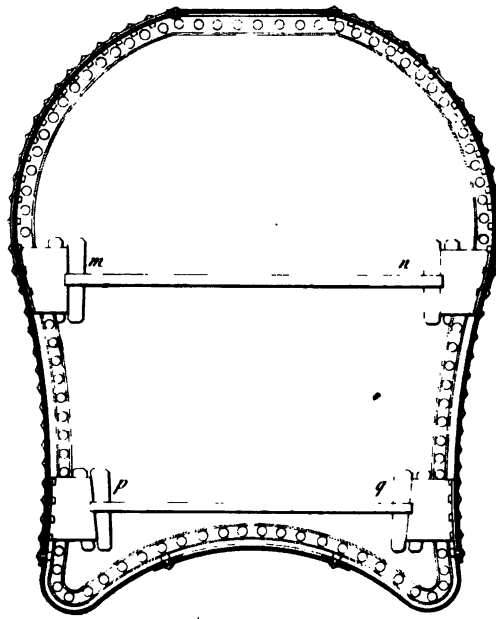


Fig. 14.

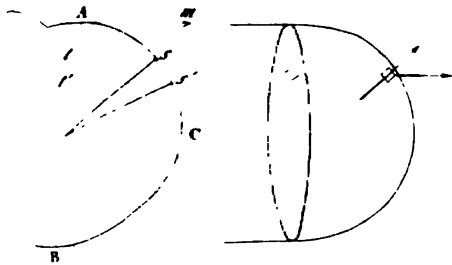


Fig. 15.

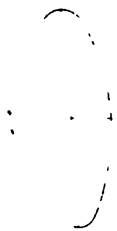


Fig. 3.

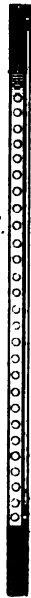


Fig. 5.

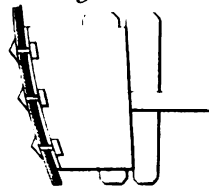


Fig. 6.

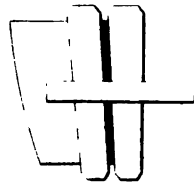


Fig. 7.

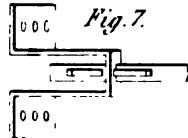
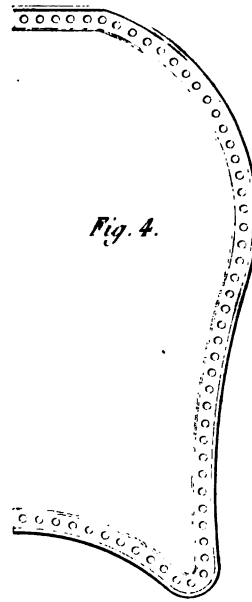
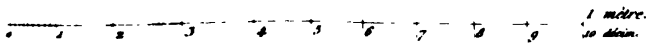
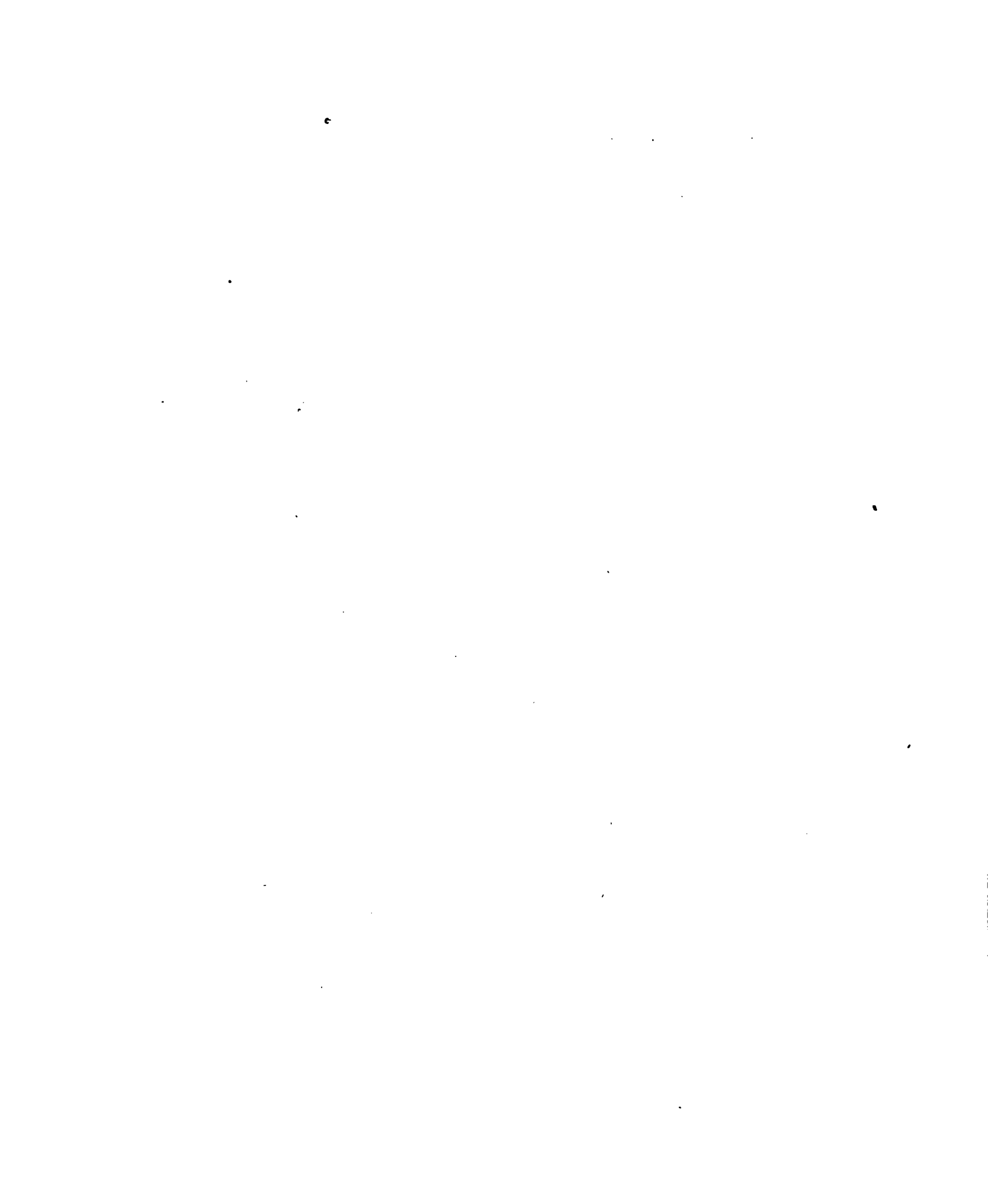


Fig. 4.



Echelle des Fig. 5, 6, 7 et 3.





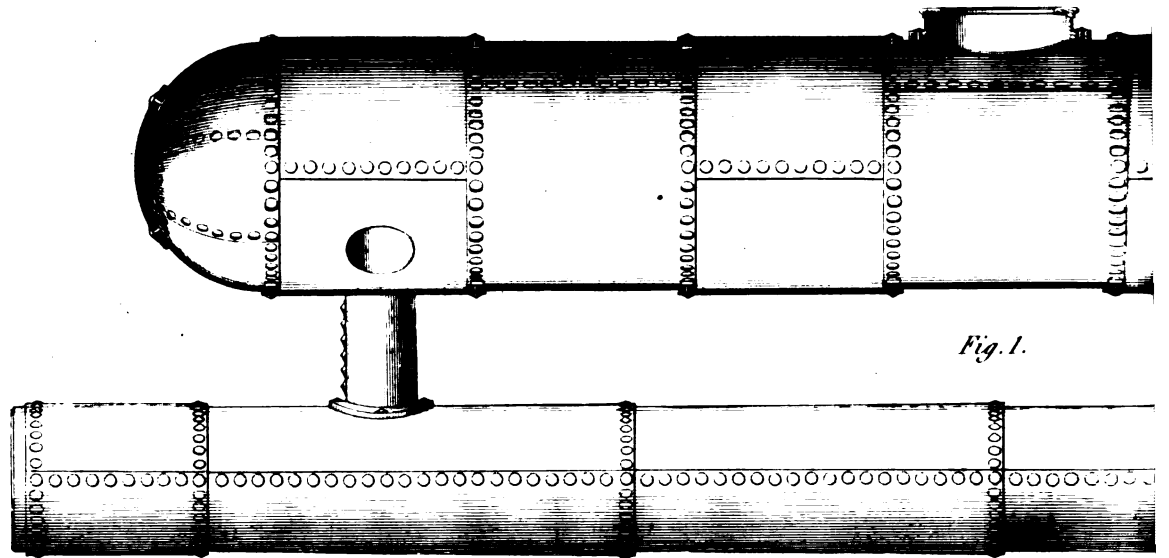


Fig. 1.

Fig. 5.

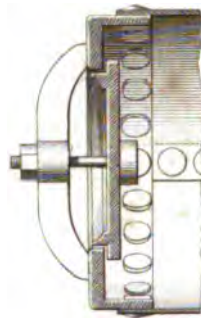
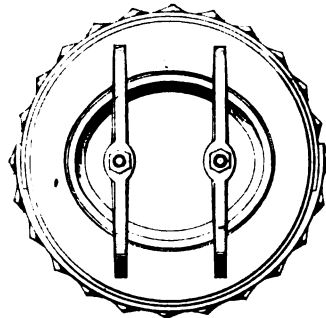


Fig. 6.



Echelle des Fig. 5, 6, 7 et 8.

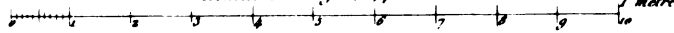


Fig. 7.

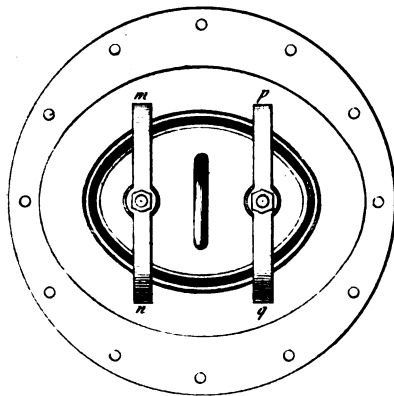
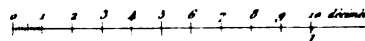
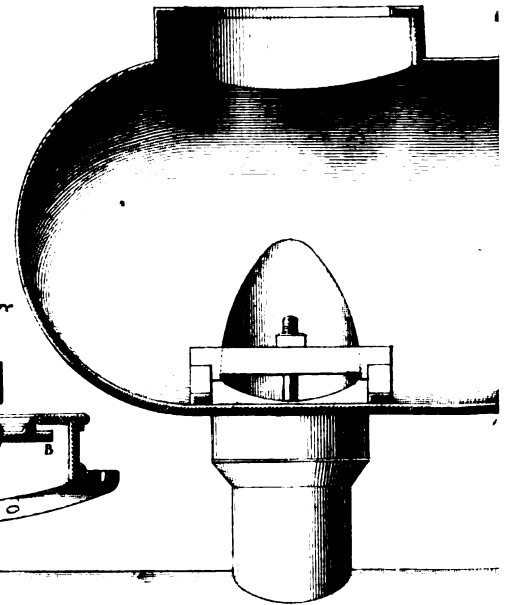
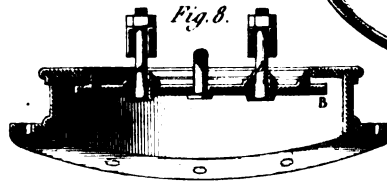
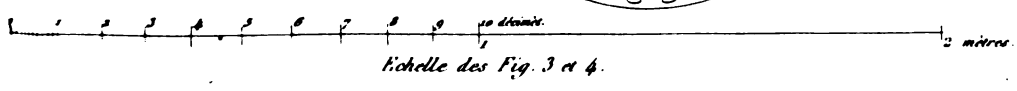
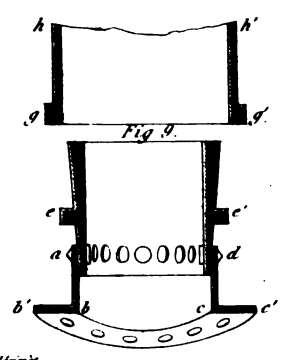
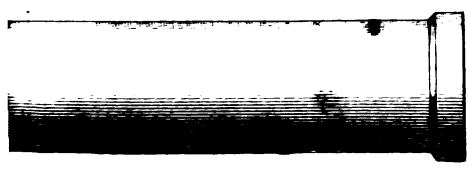
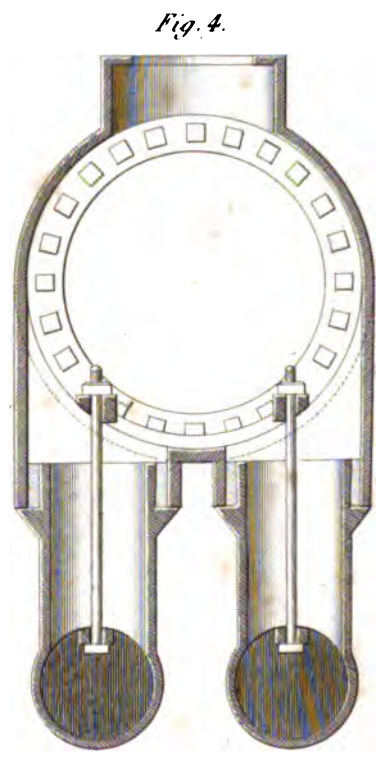
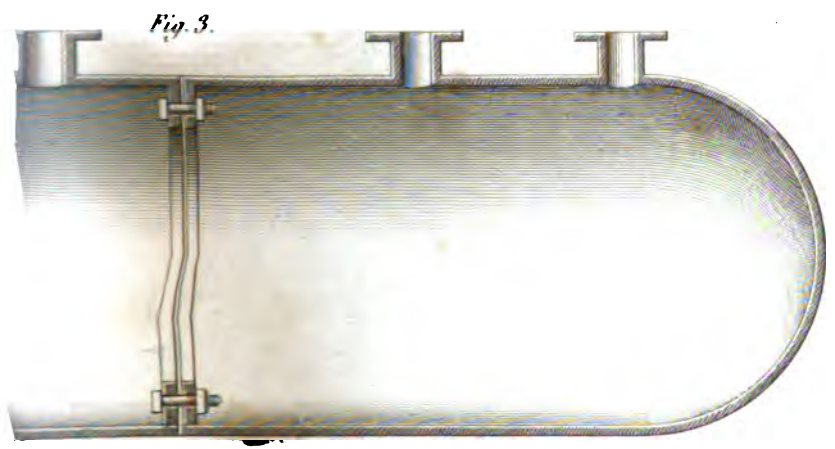
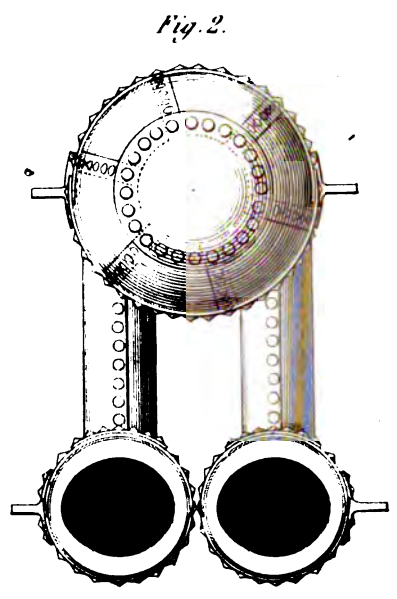
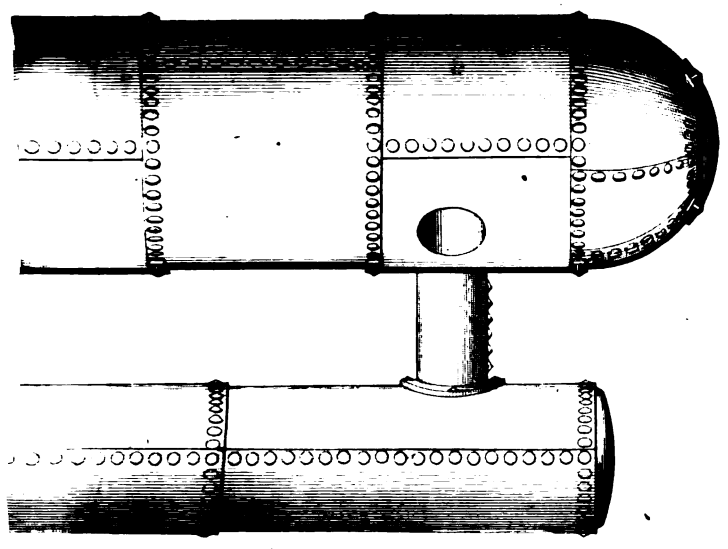


Fig. 8.



Echelle des Fig. 1 et 2.

2 mètres.



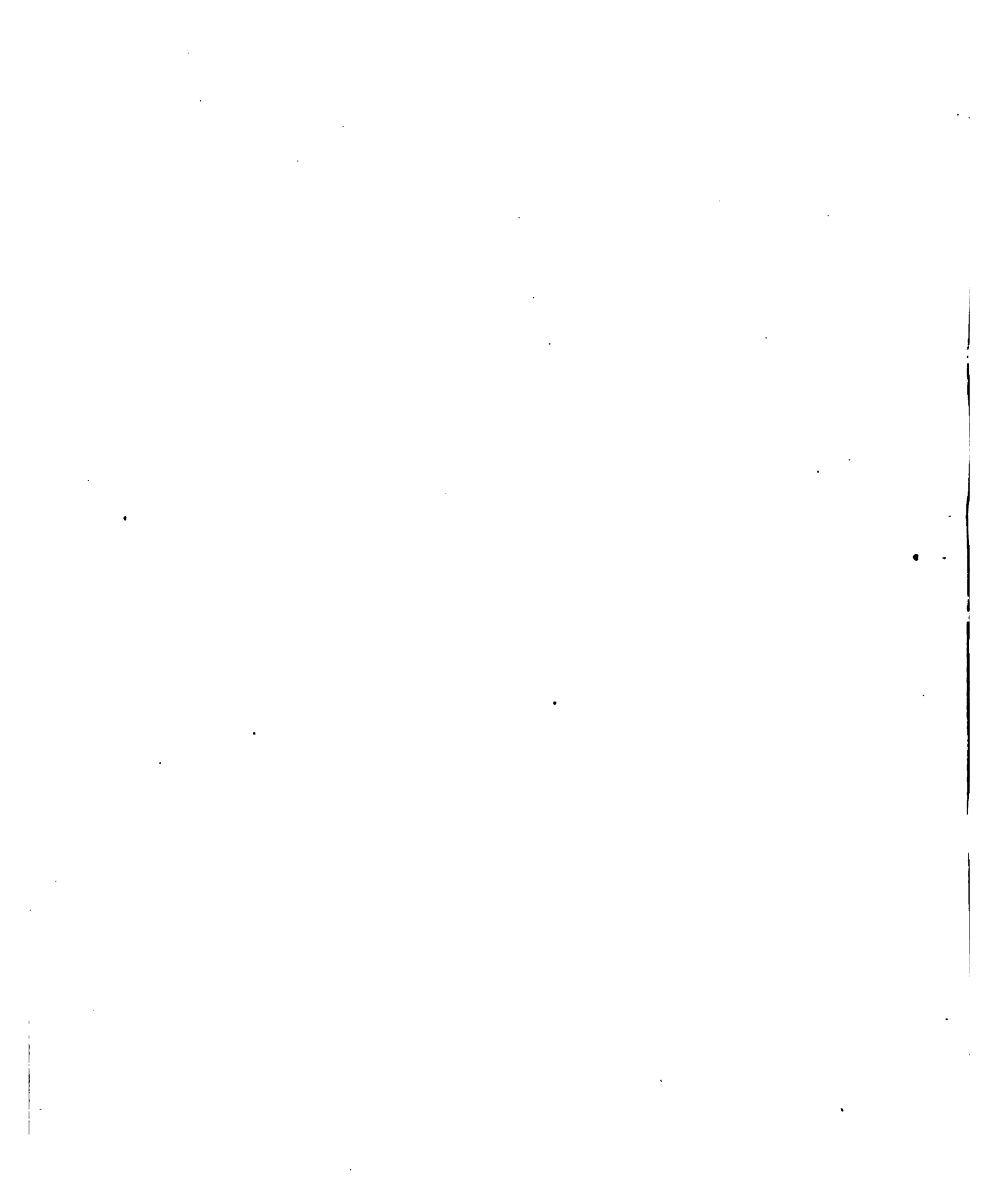




Fig. 1.

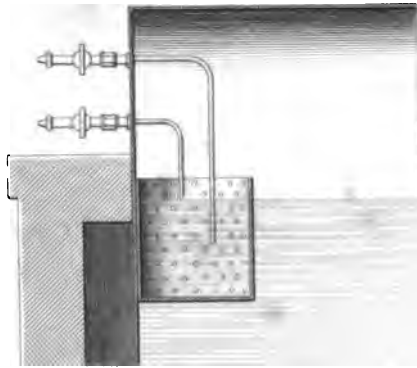


Fig. 2.

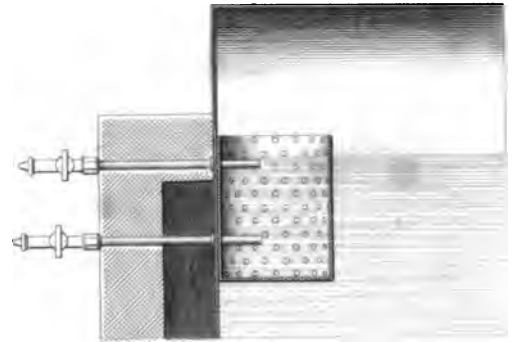


Fig. 7.

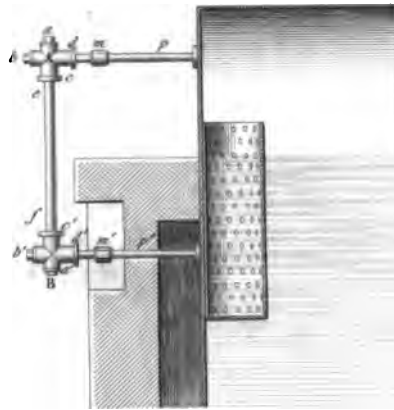


Fig. 8.

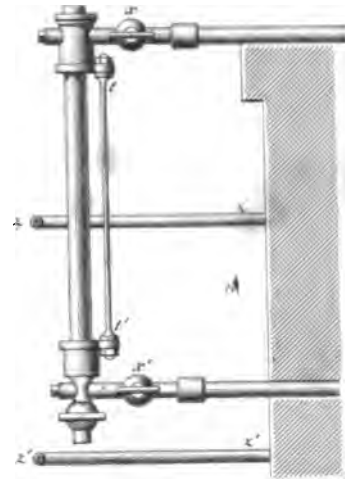


Fig. 9.

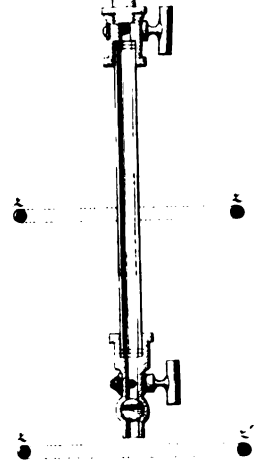


Fig. 6.

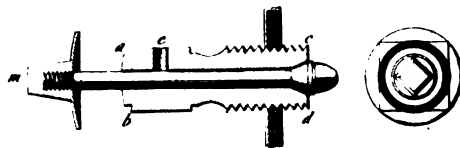


Fig. 10.

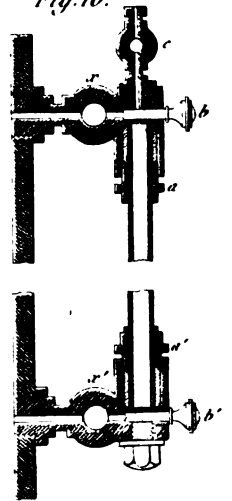
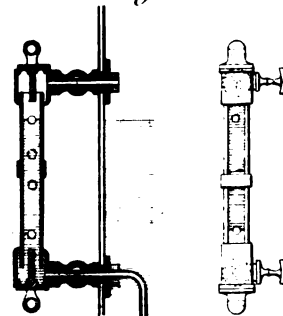


Fig. 18.



Echelle des Fig. 13 et 14.

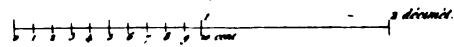


Fig. 3.

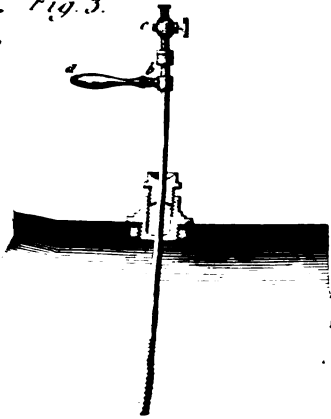


Fig. 4.

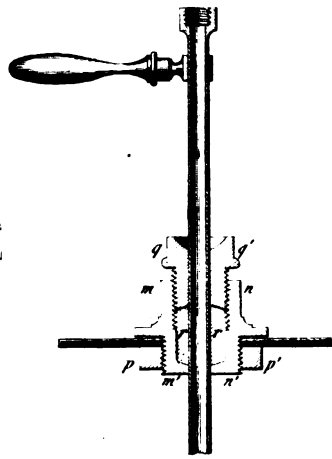


Fig. 5.

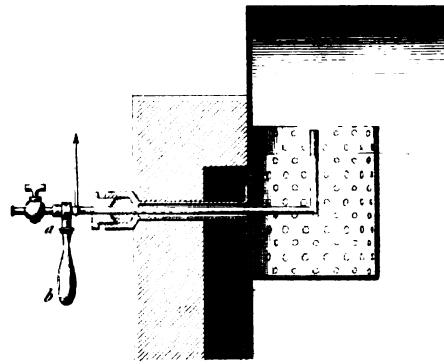


Fig. 13.

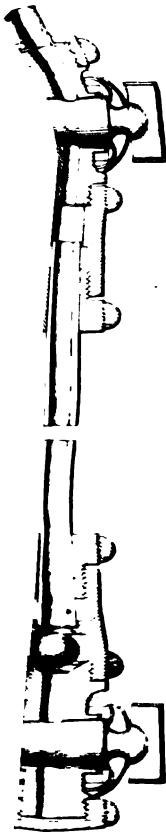


Fig. 14.

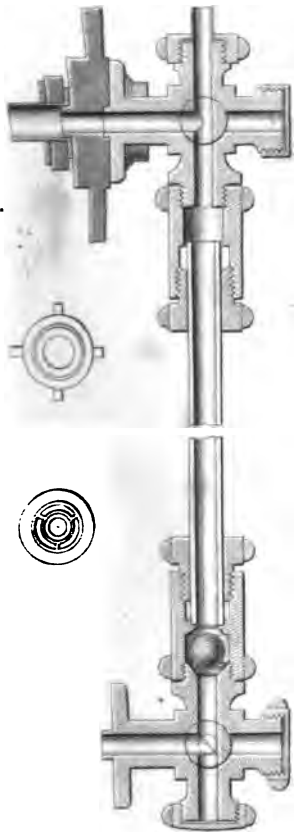


Fig. 11.



Fig. 12.

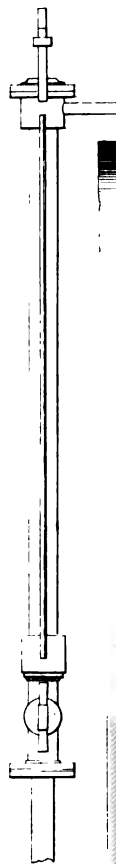


Fig. 15.

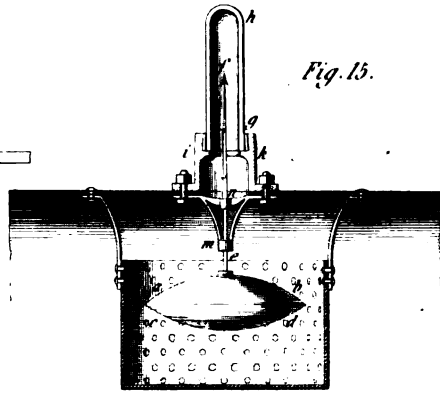


Fig. 16.

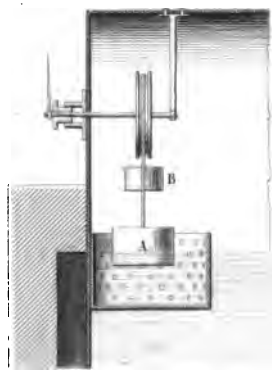
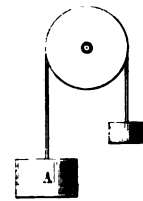
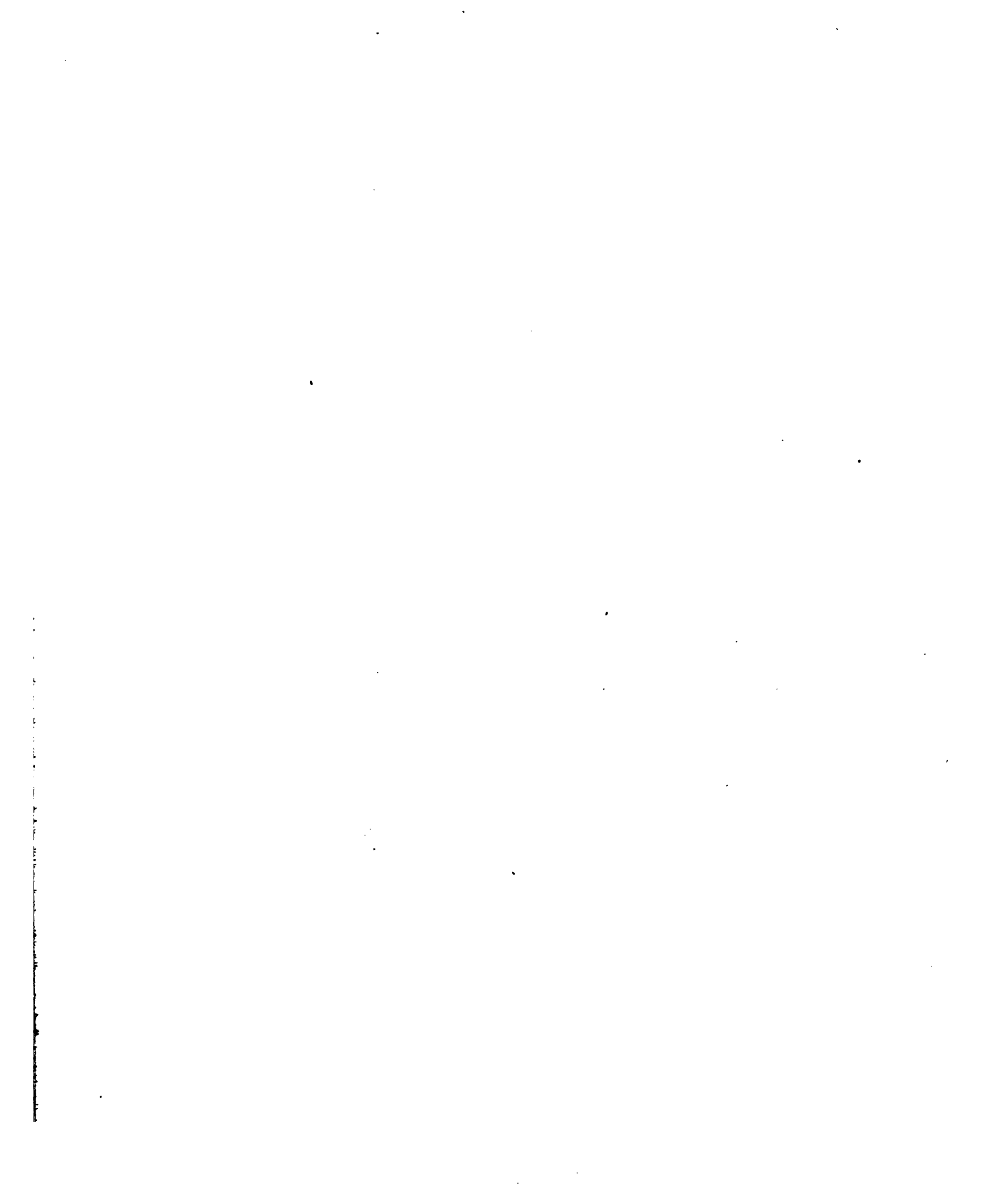
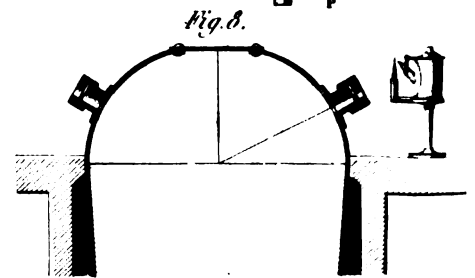
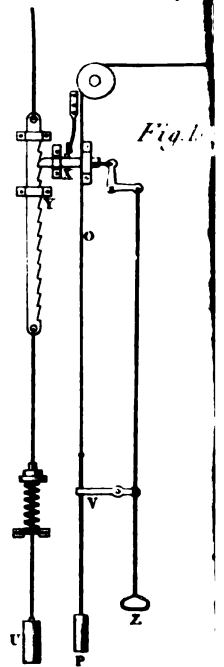
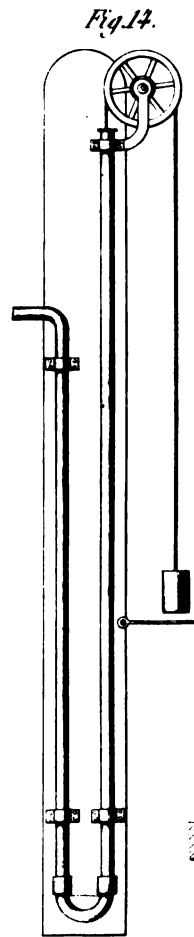
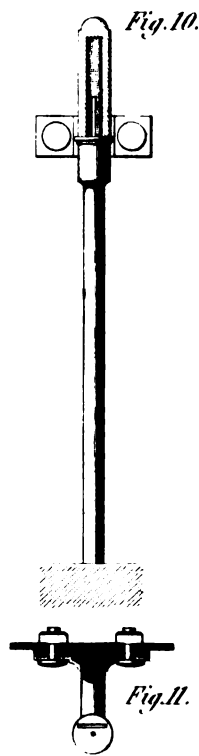
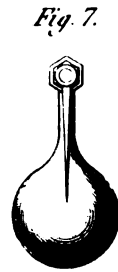
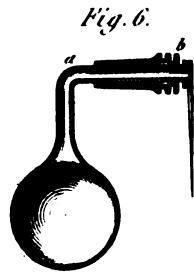
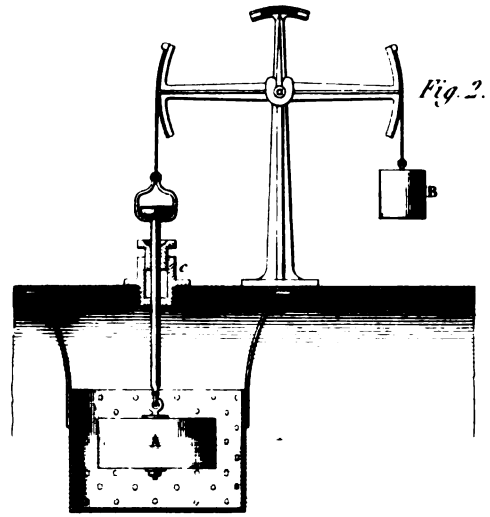
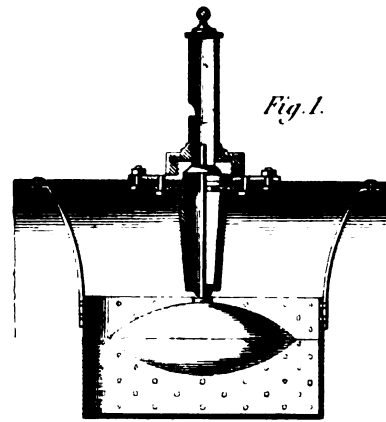


Fig. 17.









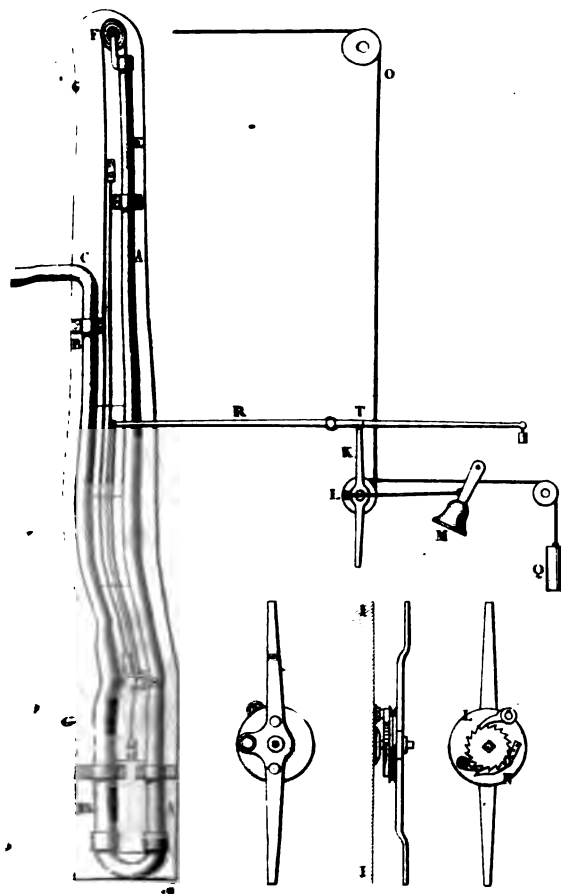
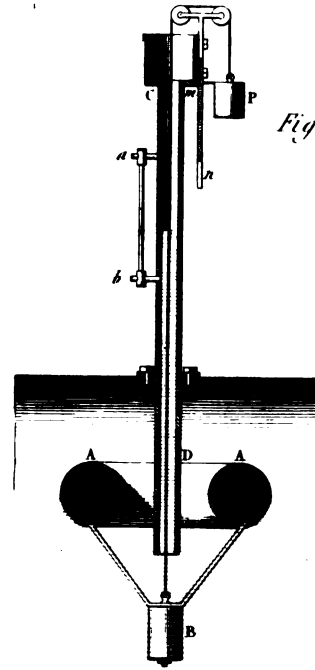
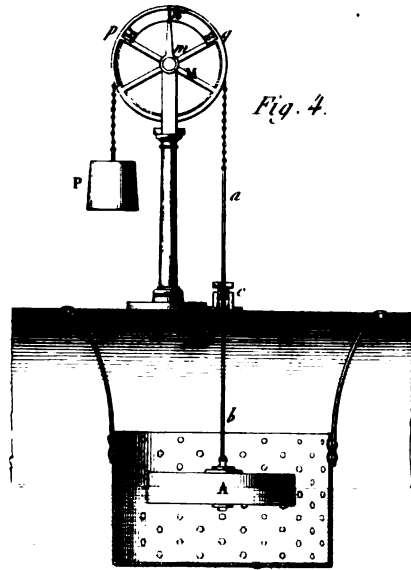
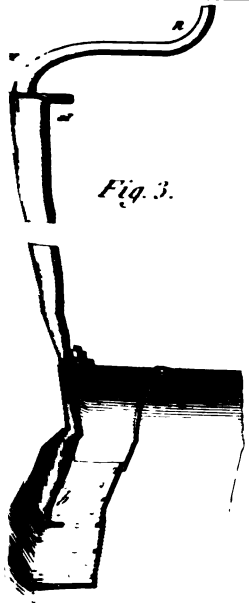


Fig. 13.

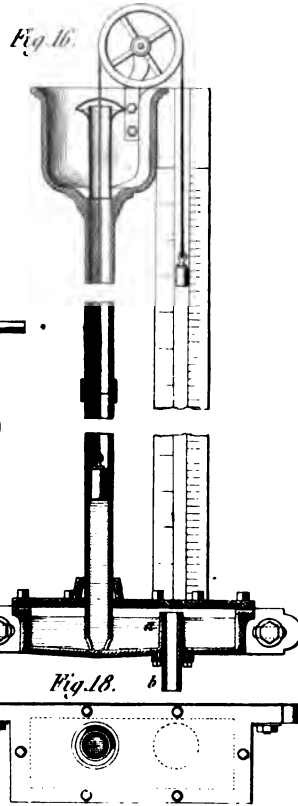
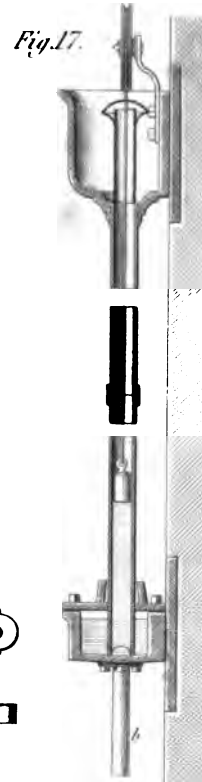
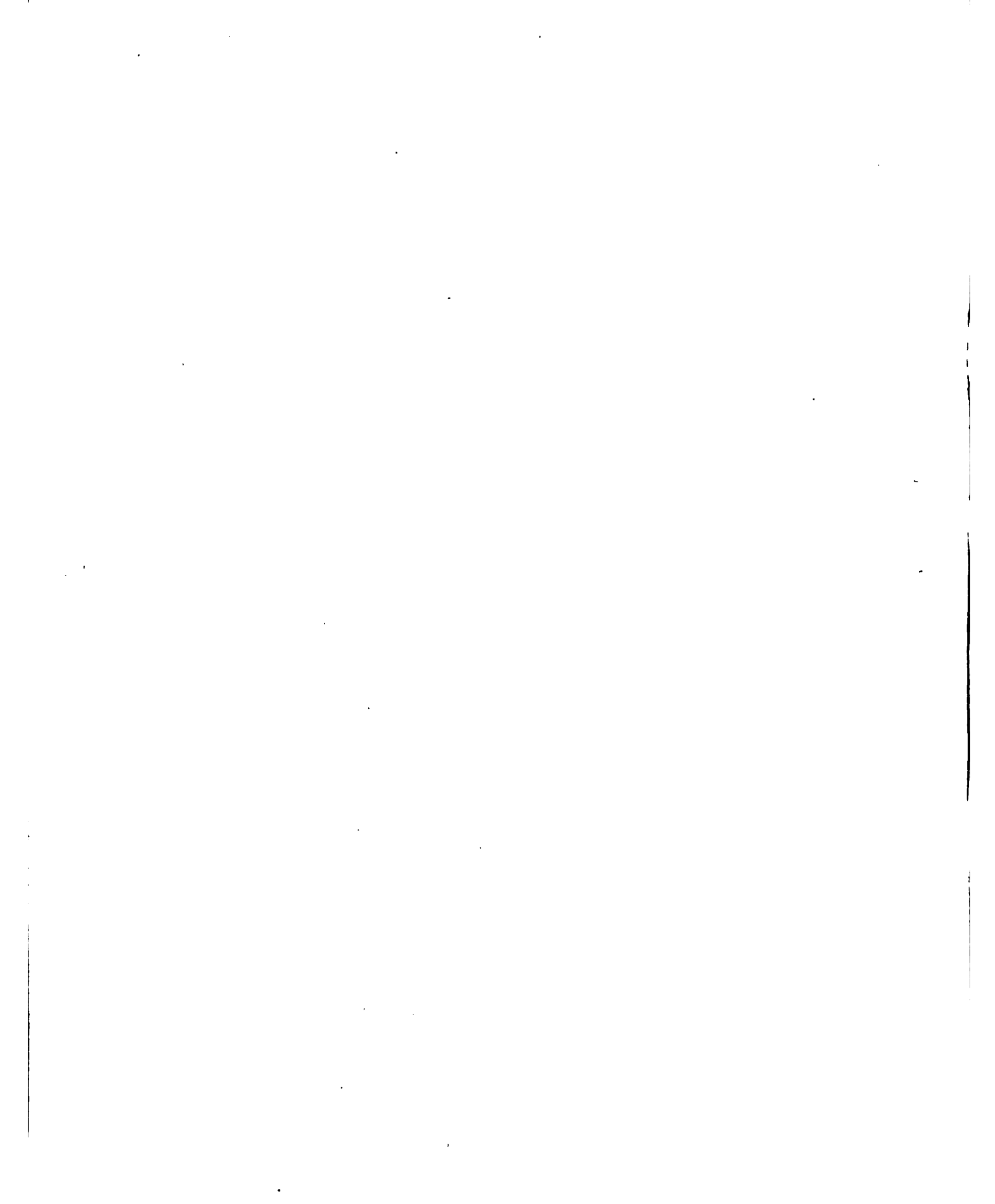


Fig. 18.







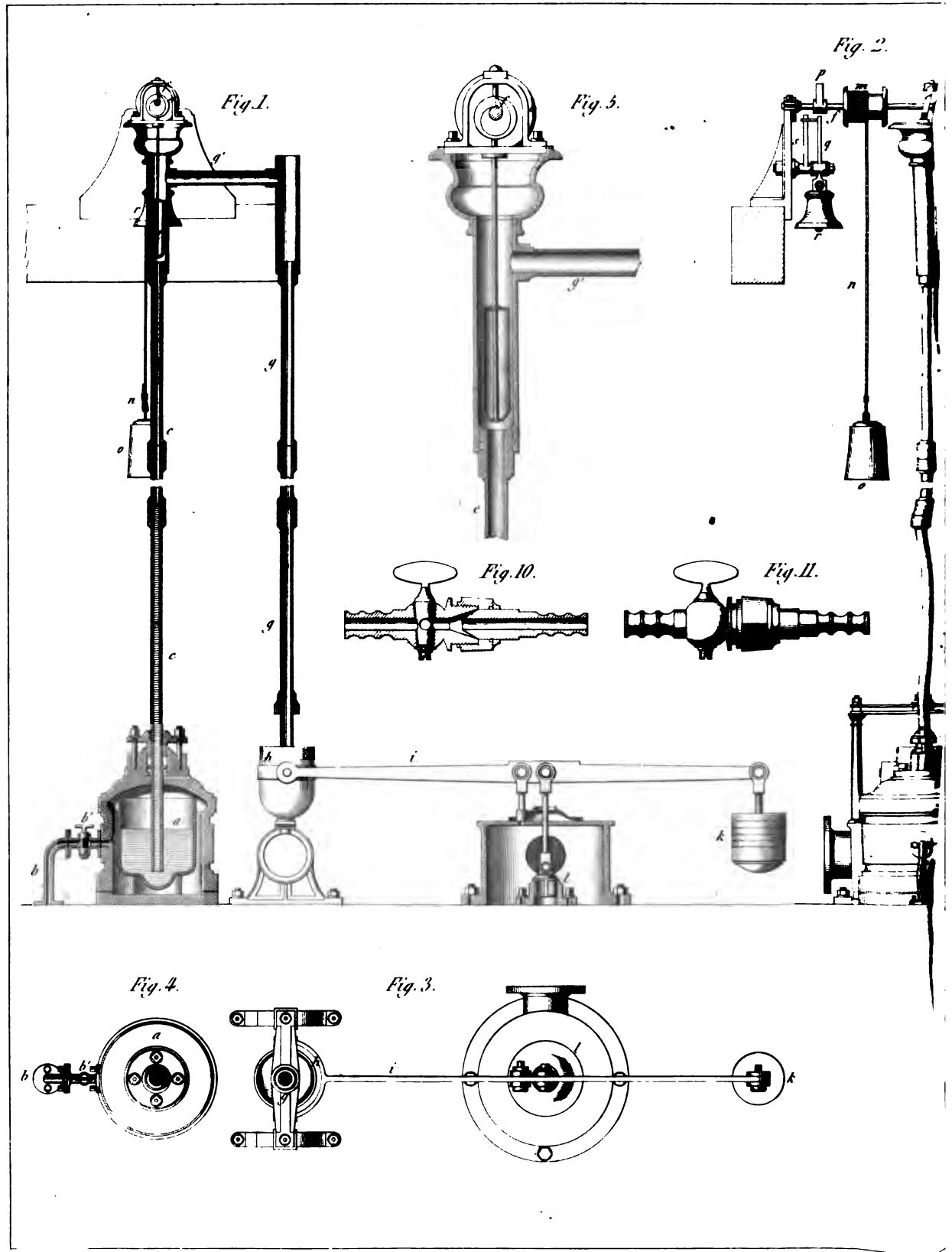


Fig. 6.

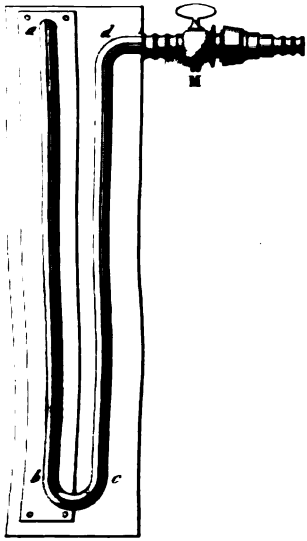


Fig. 7.

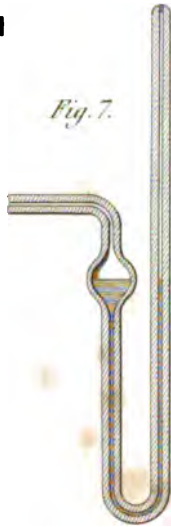


Fig. 8.

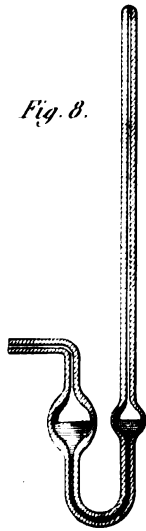


Fig. 9.

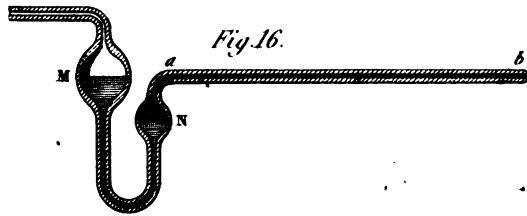
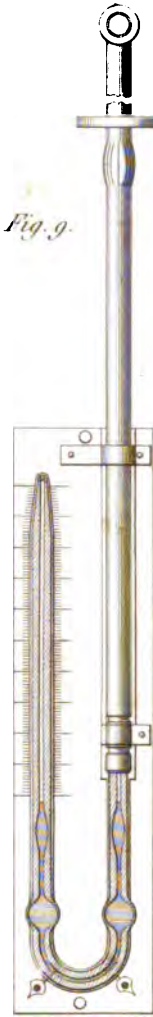


Fig. 14.

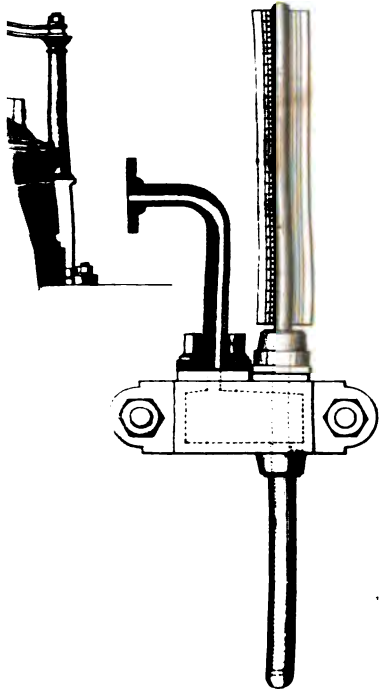


Fig. 15.

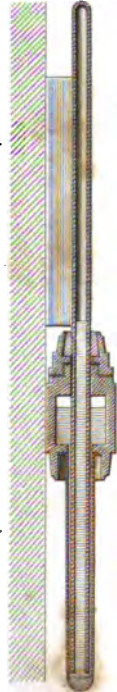


Fig. 12.

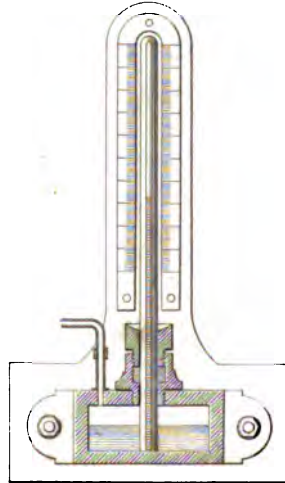
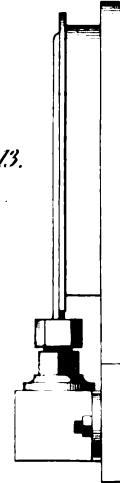
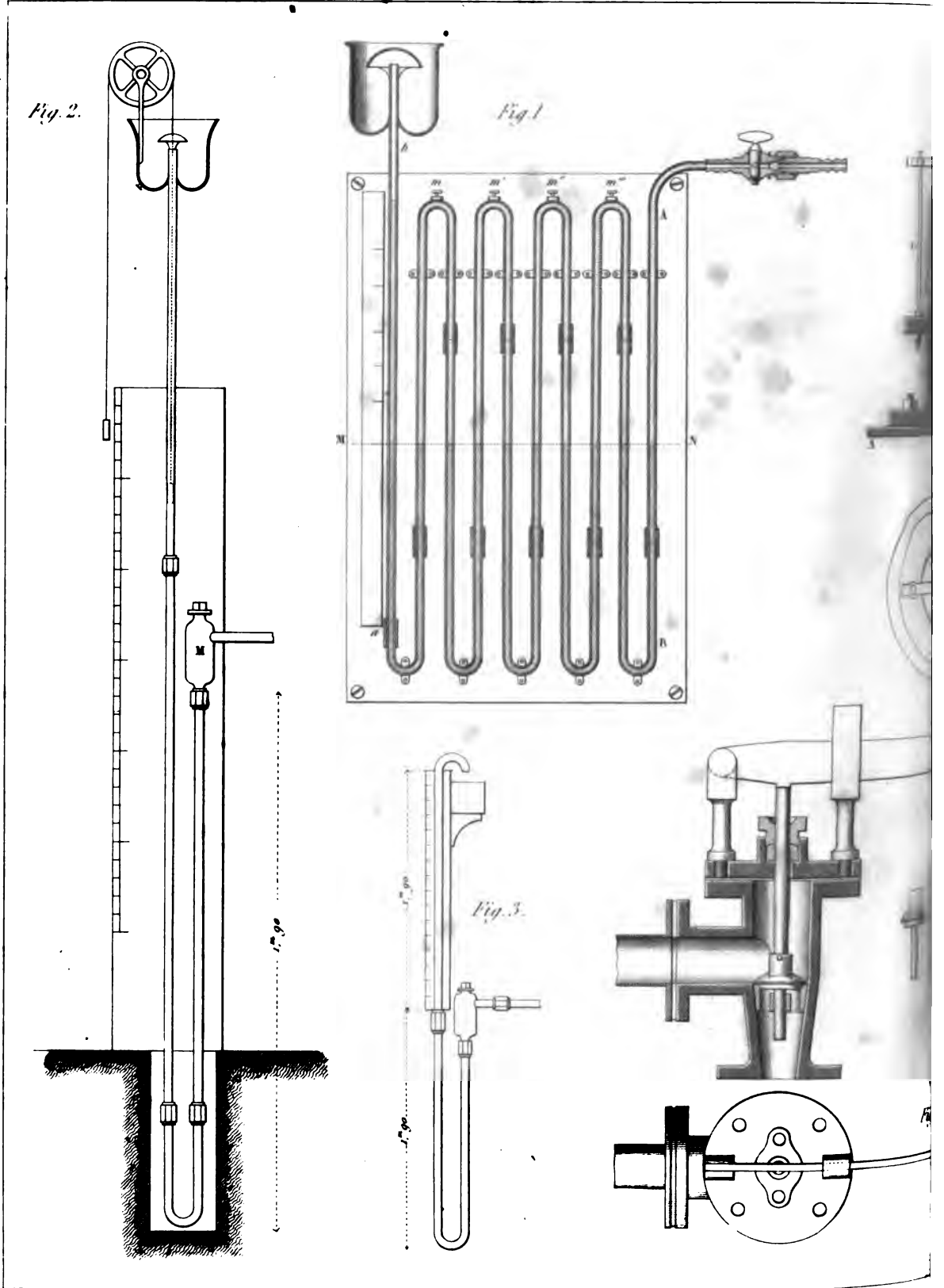


Fig. 13.







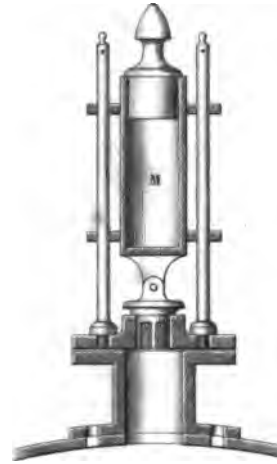
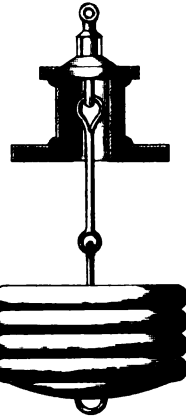
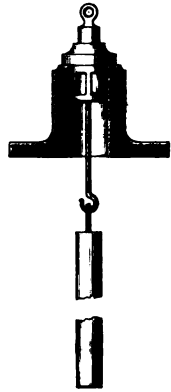
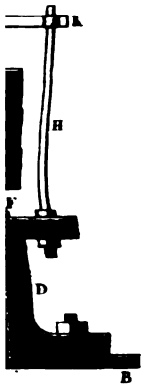
2.

Fig. 6.

Fig. 8.

Fig. 9.

Fig. 10.



3.

Fig. 7.

Fig. 16.

Fig. 11.

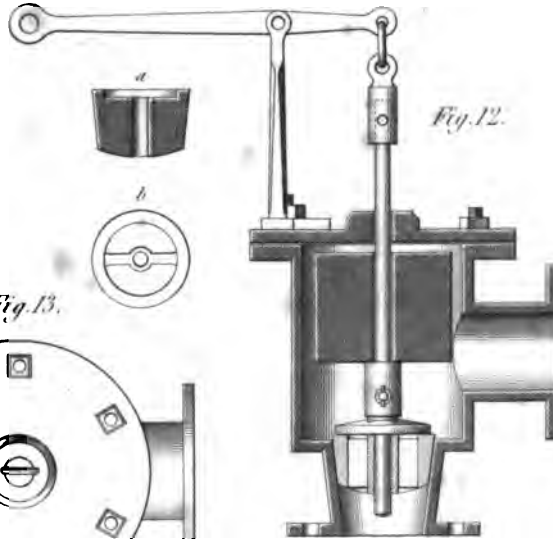
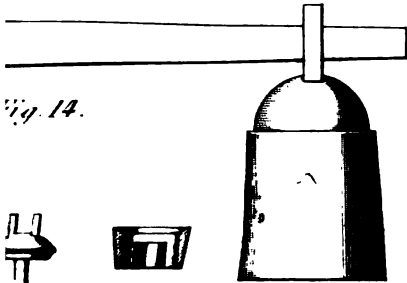
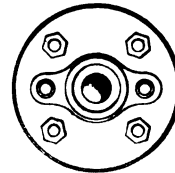
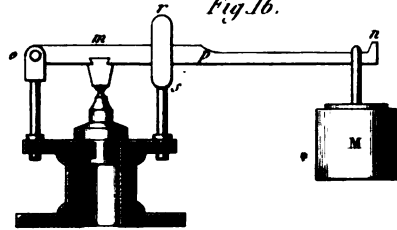
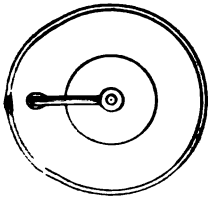
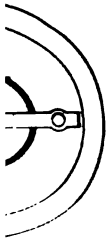


Fig. 14.

Fig. 12.

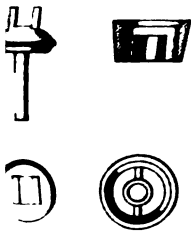
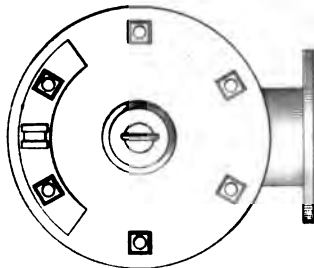
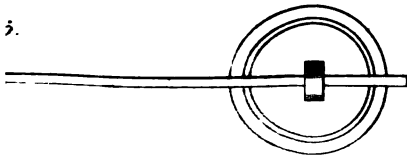


Fig. 13.



5.



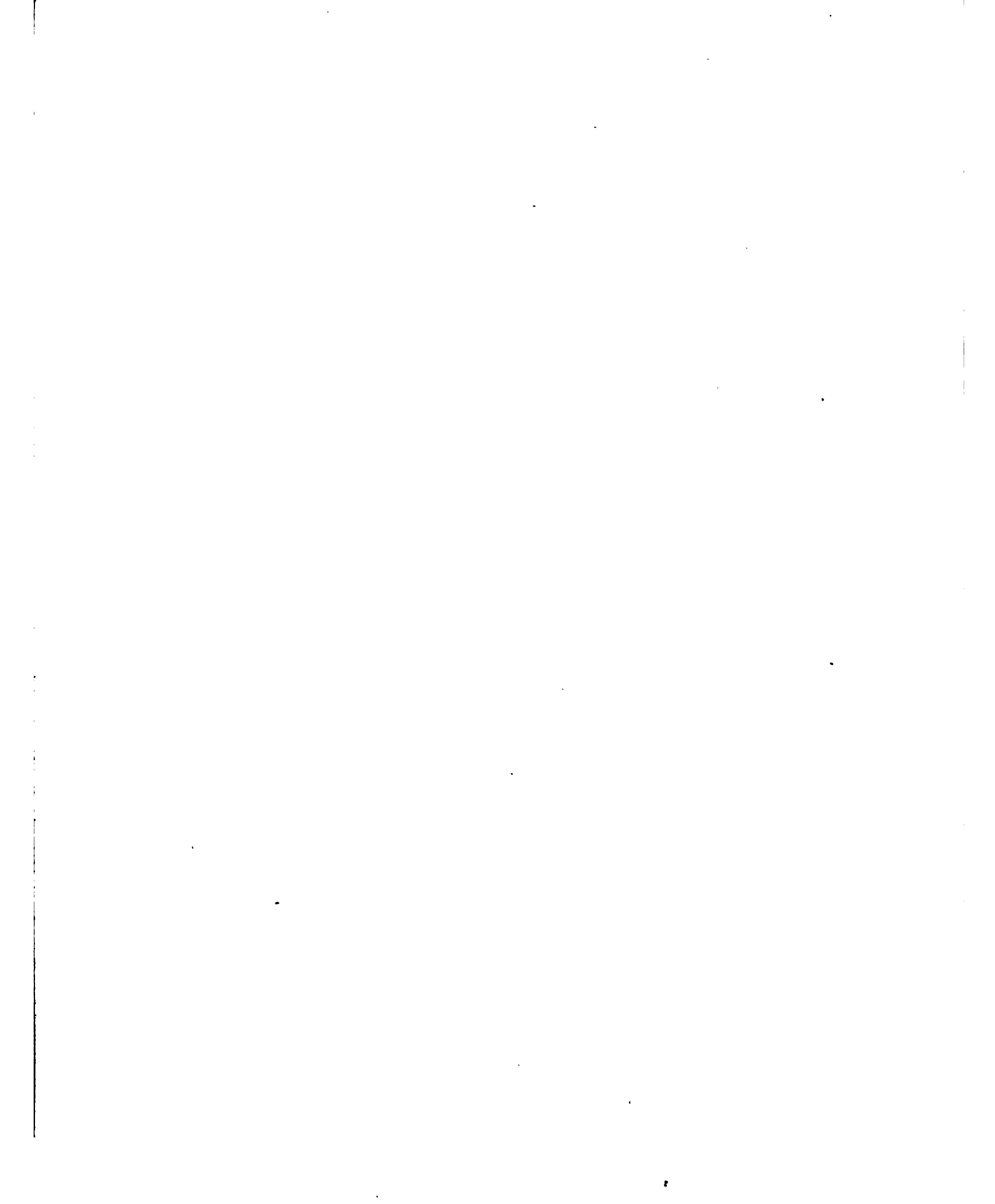


Fig. 6.

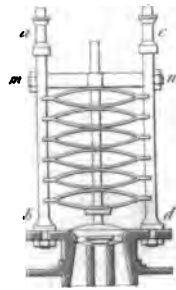


Fig. 18.

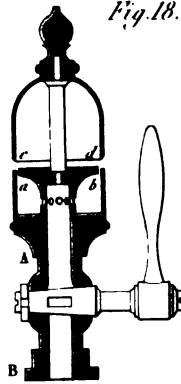


Fig. 7.

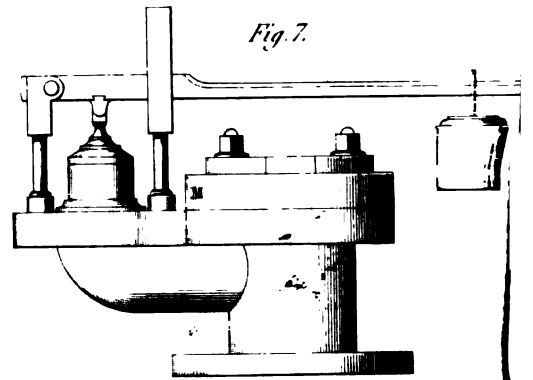


Fig. 5.

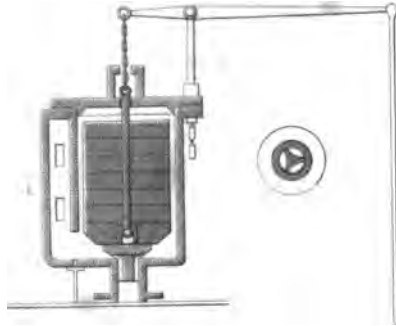


Fig. 14.

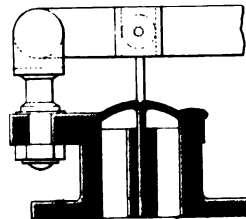


Fig. 17.

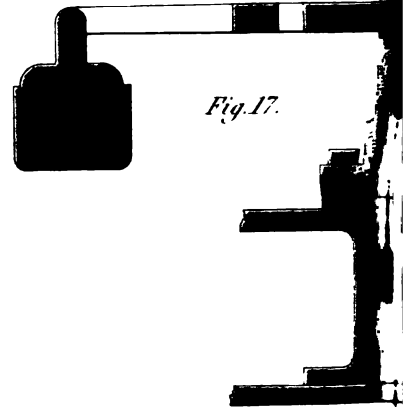


Fig. 15.

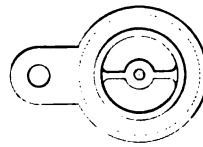


Fig. 16.

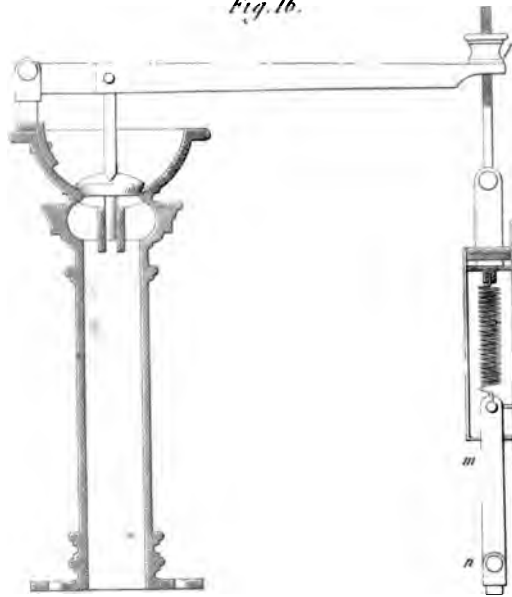


Fig. 1.

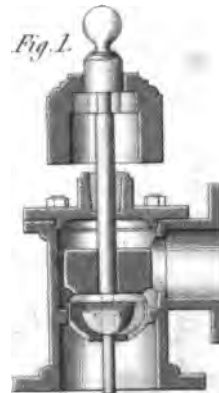


Fig. 2.

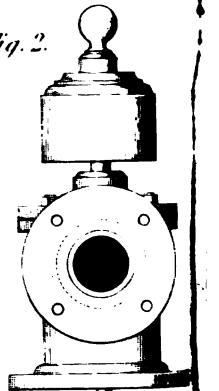
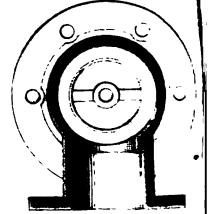
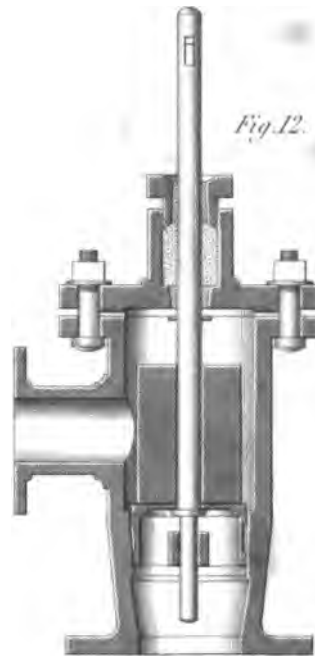
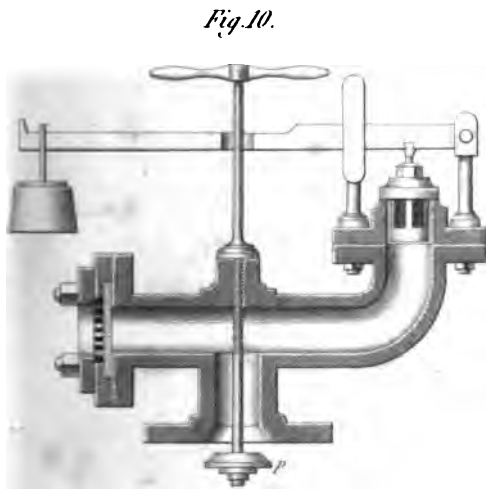
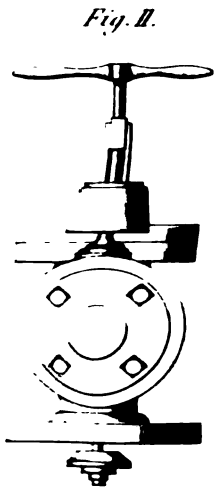
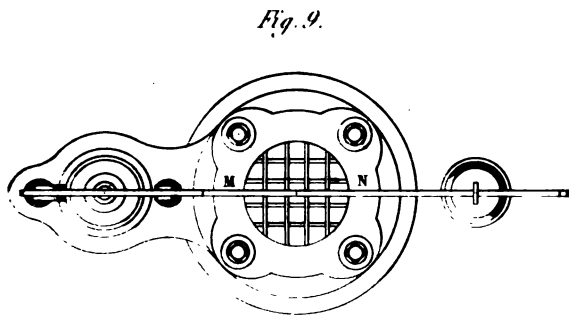
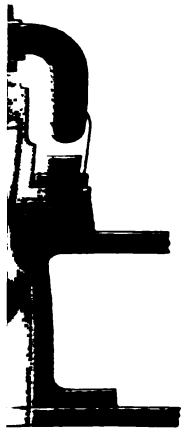
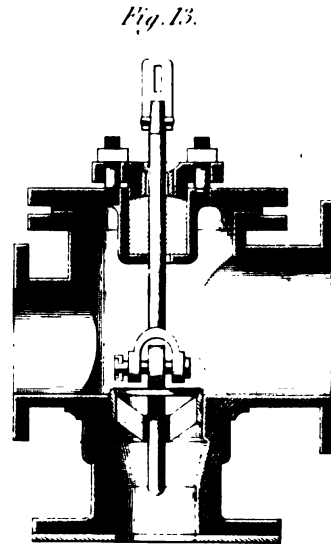
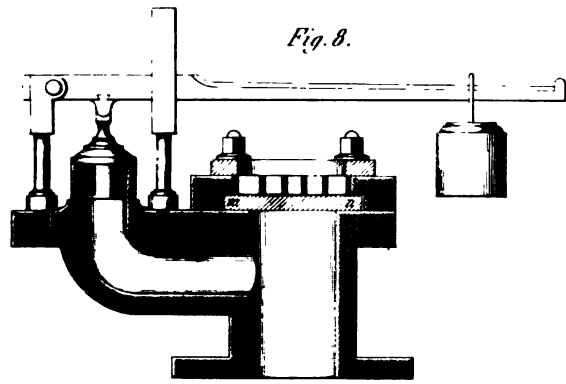


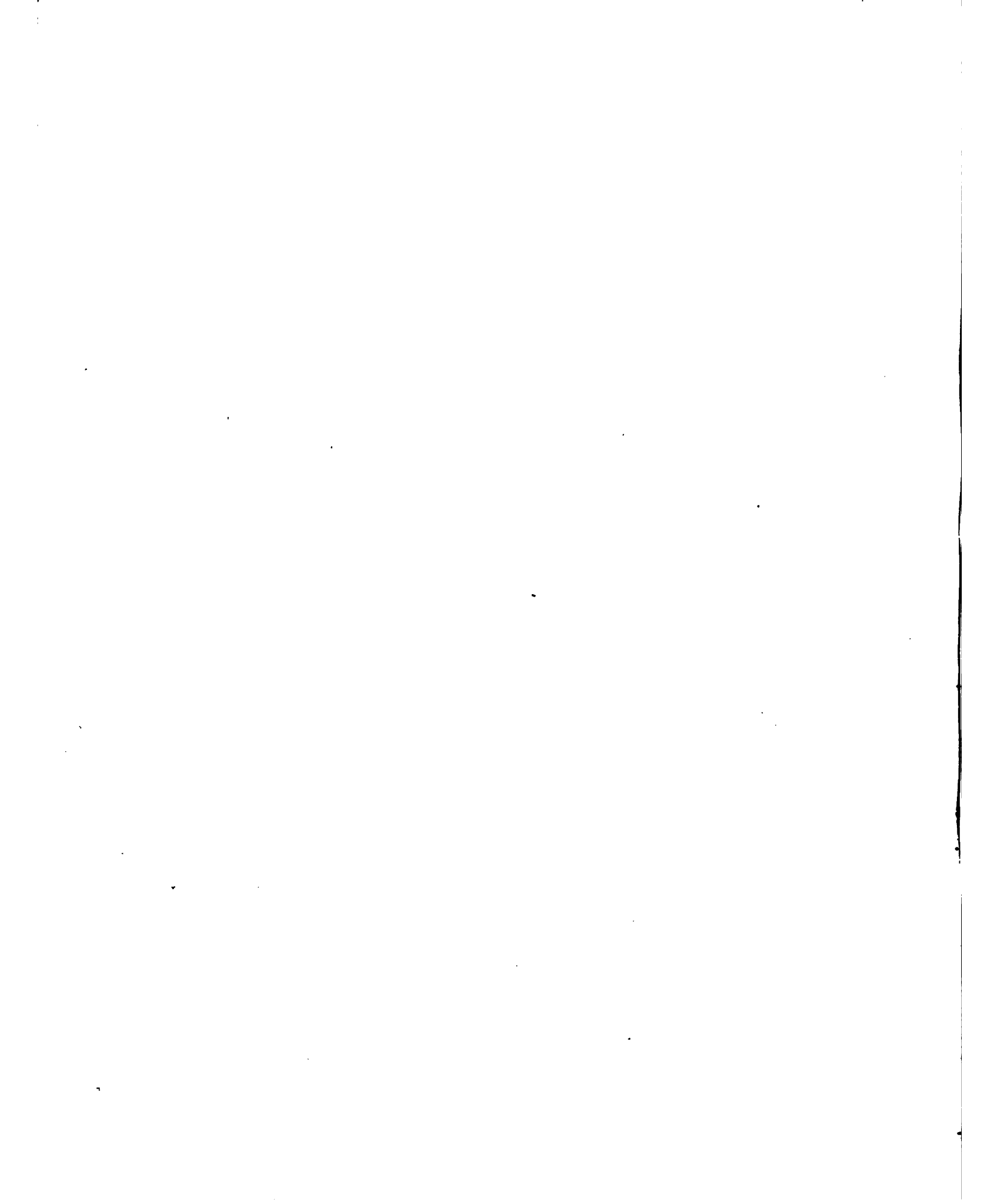
Fig. 3.



Fig. 4.









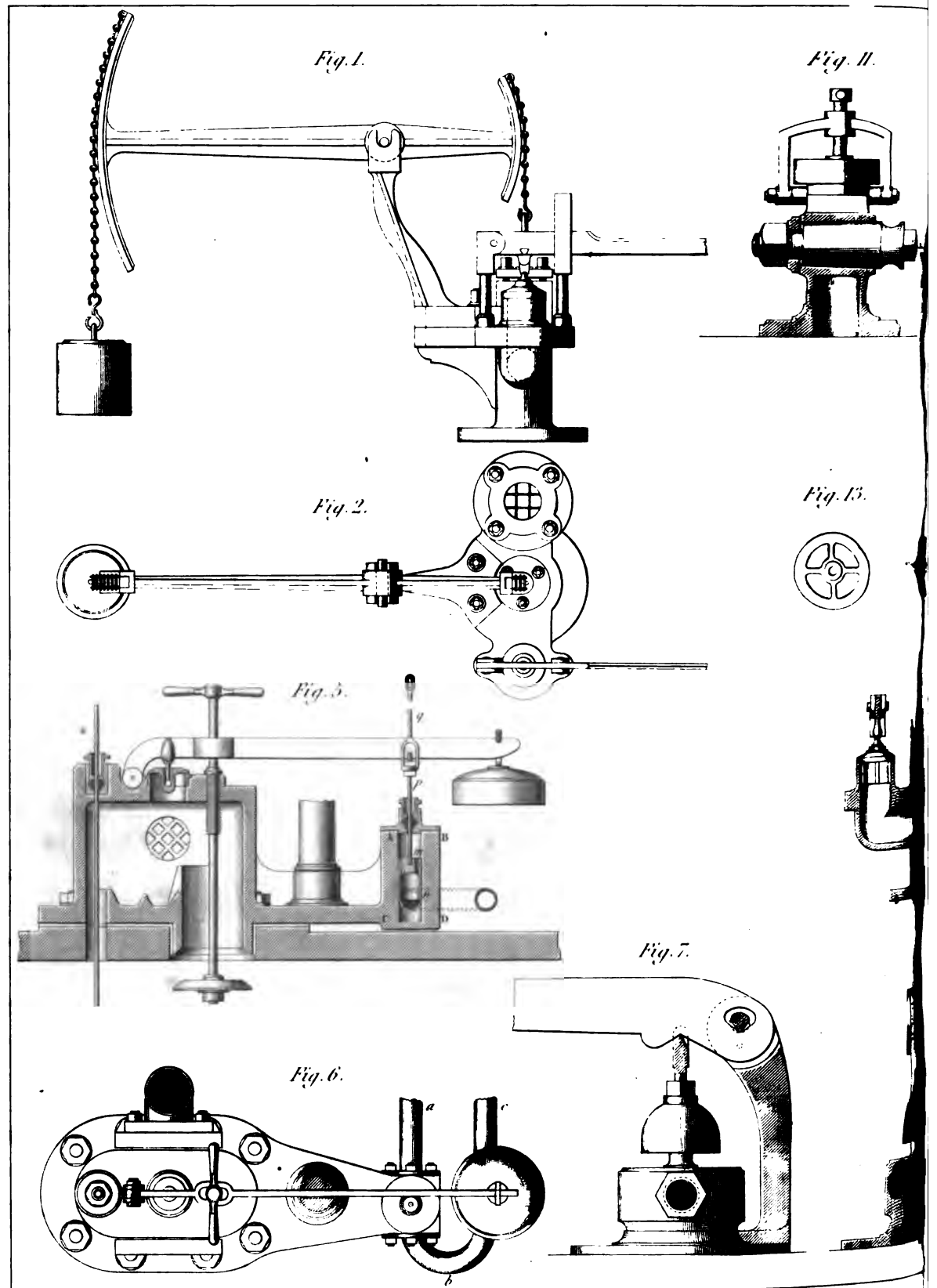


Fig. 10.

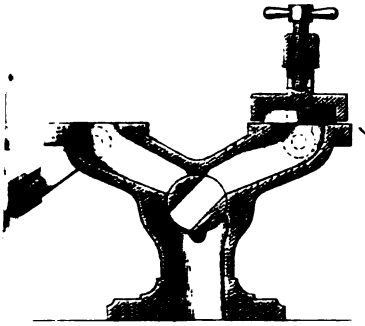


Fig. 4.

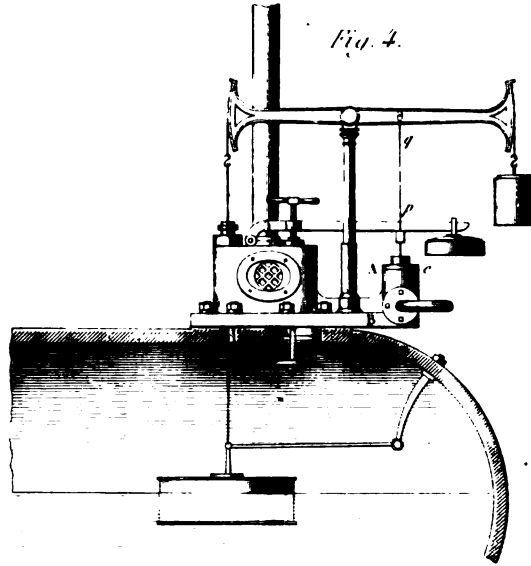


Fig. 12.

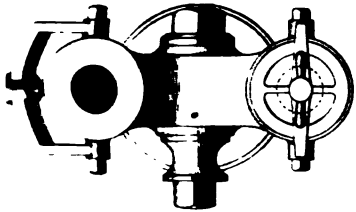


Fig. 9.

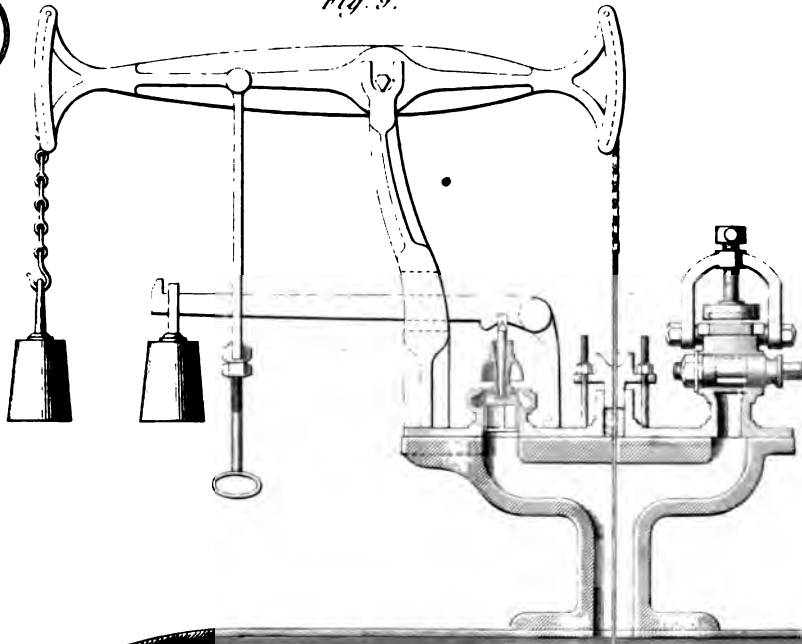
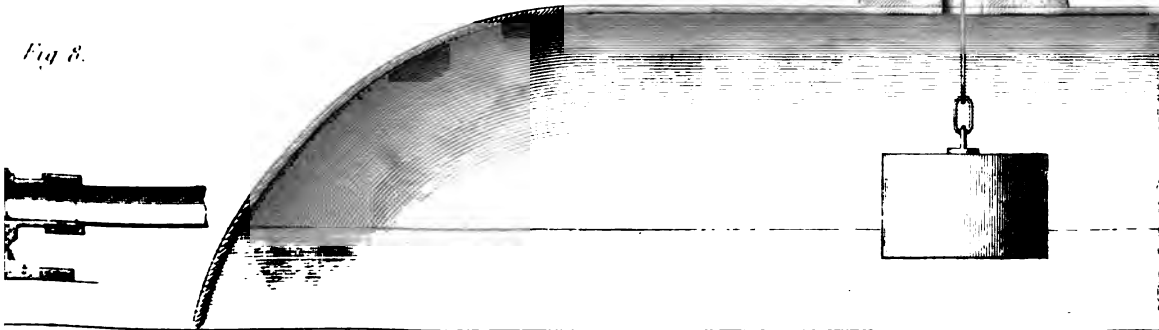
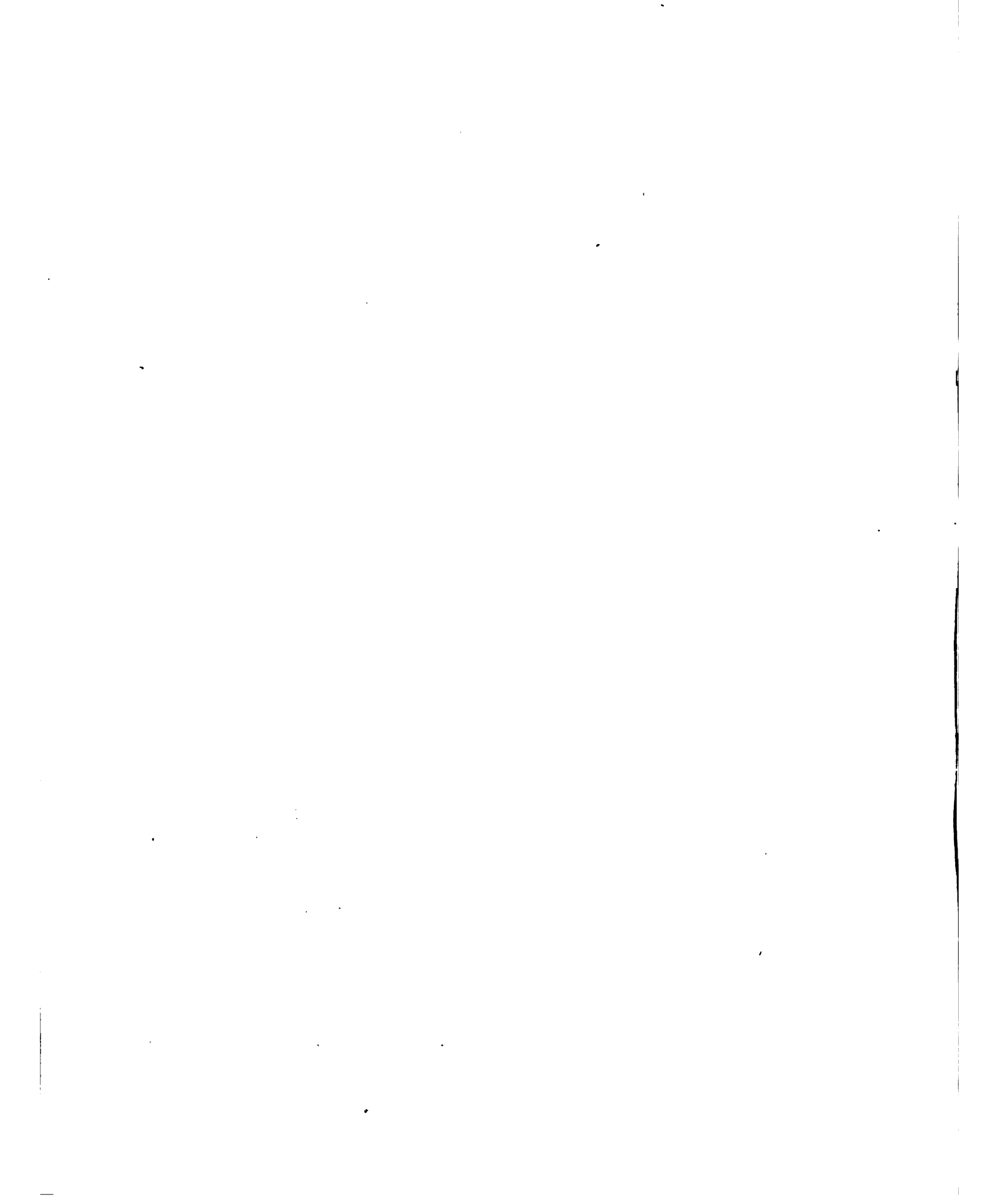


Fig. 3.



Fig. 8.





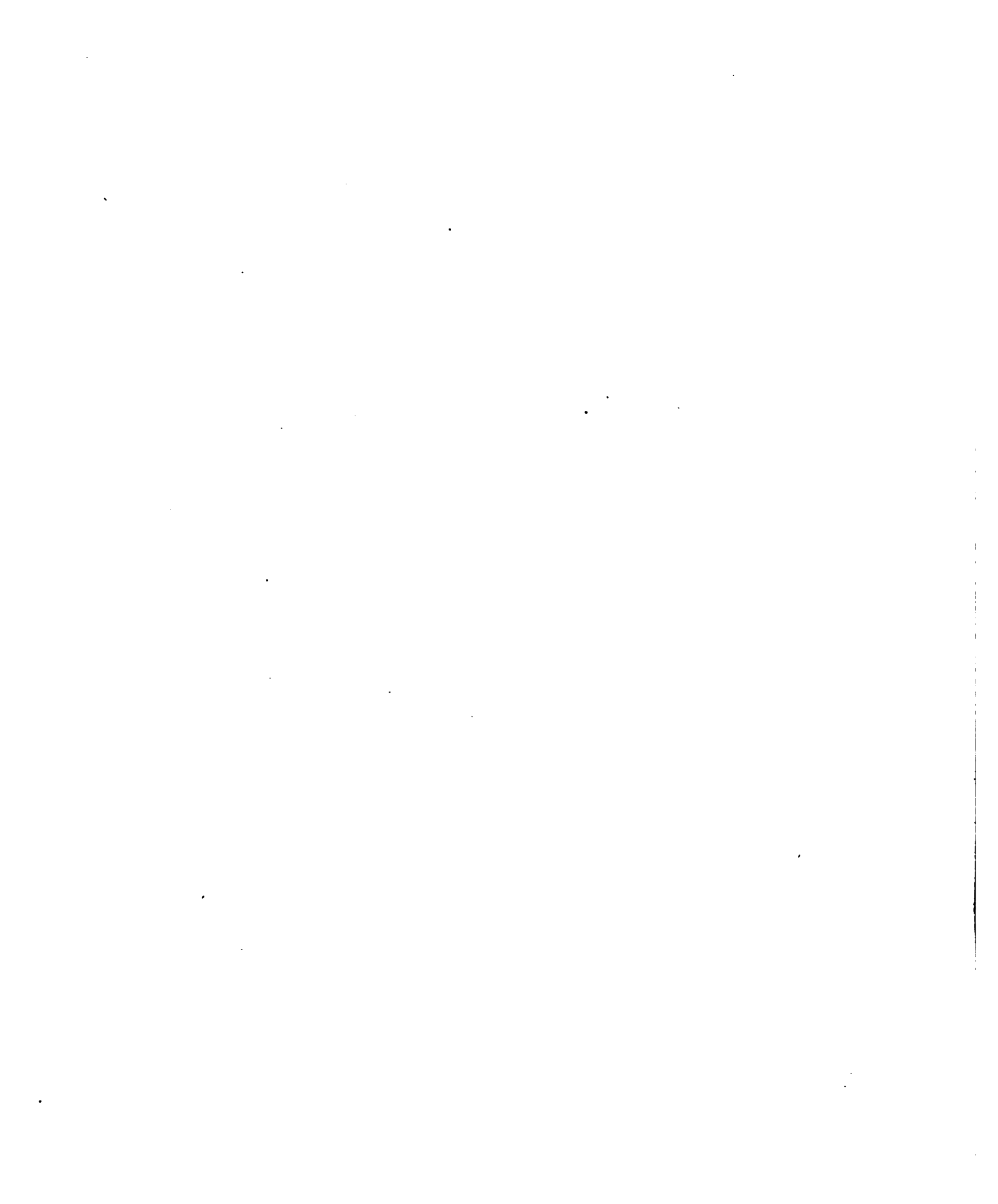


Fig. 1.

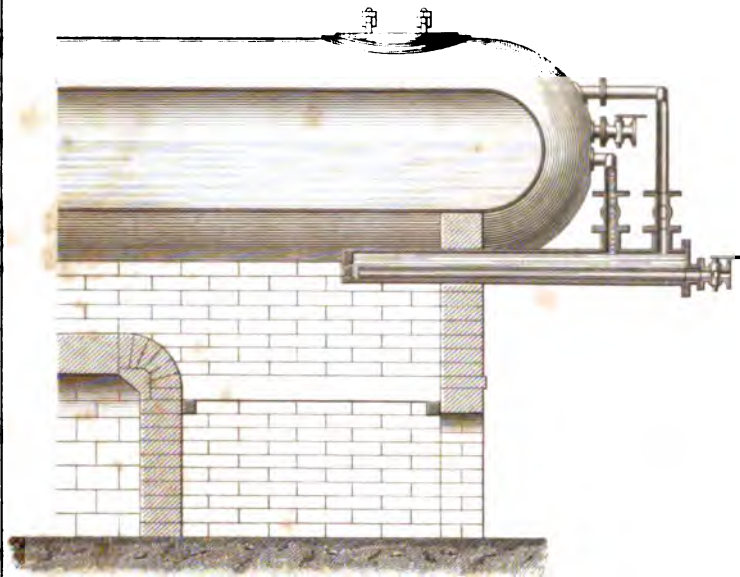


Fig. 2.

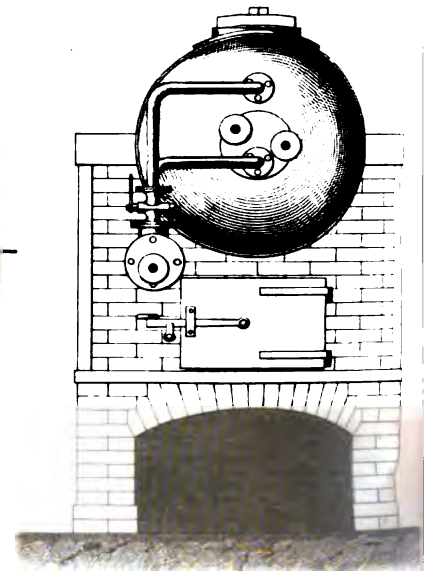


Fig. 9.

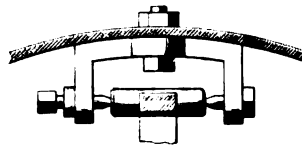


Fig. 8.

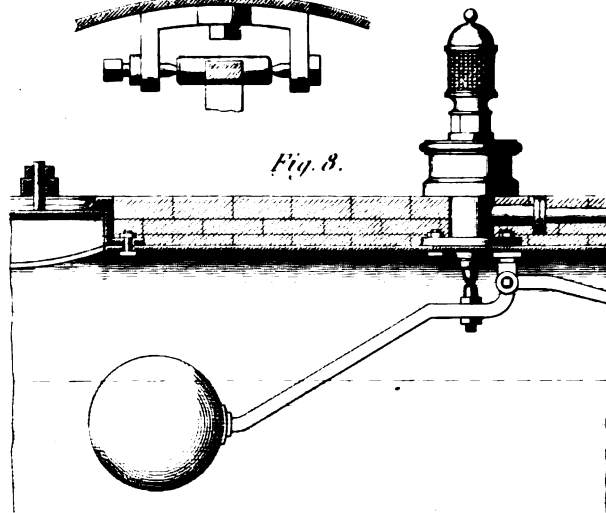


Fig. 11.

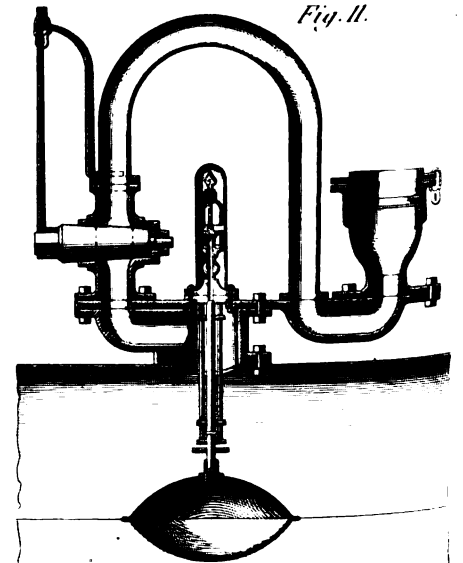


Fig. 3.

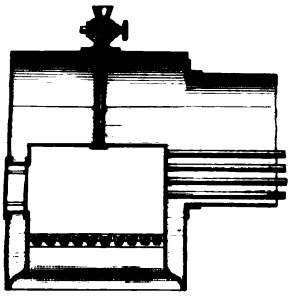


Fig. 5.

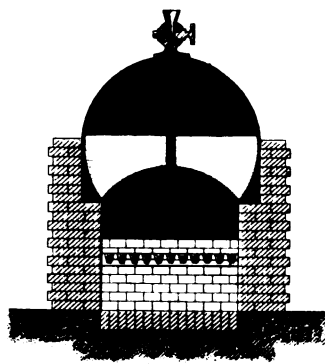


Fig. 7.

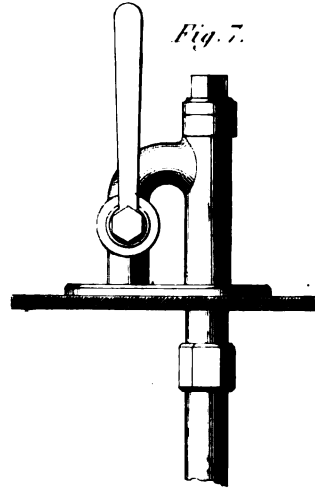


Fig. 4.

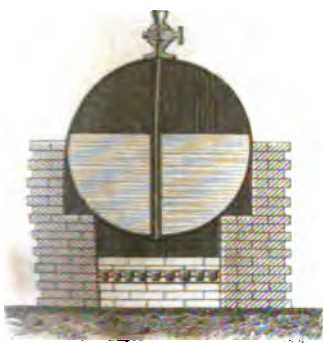


Fig. 6.

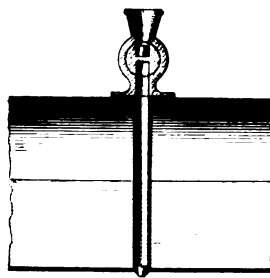


Fig. 10.

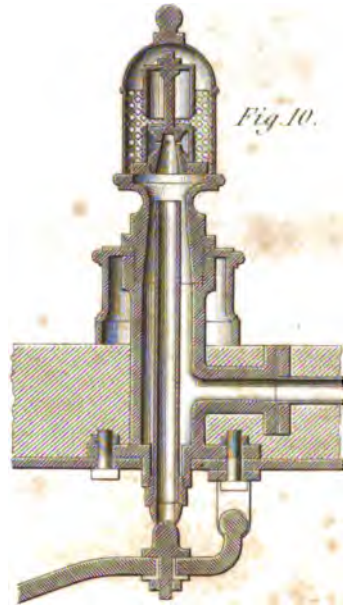


Fig. 12.

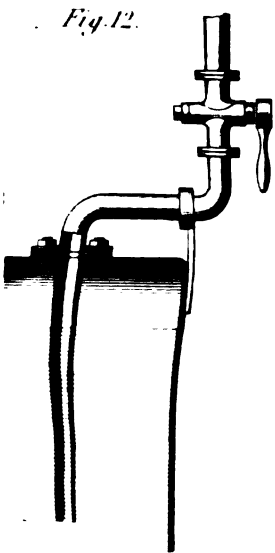


Fig. 13.

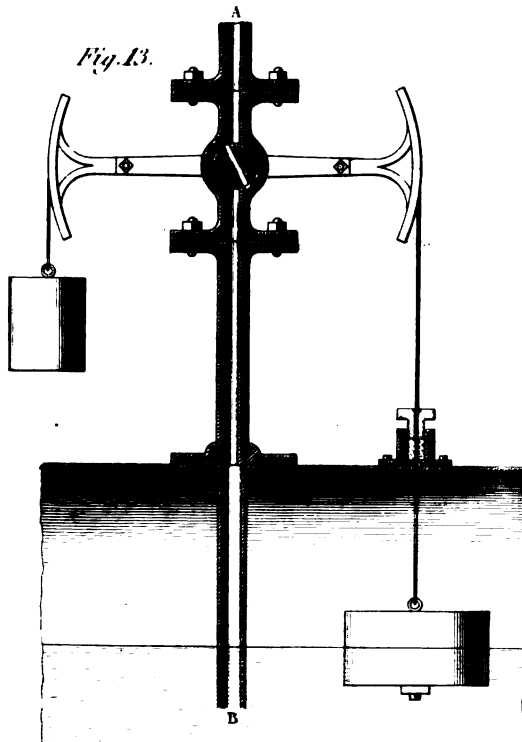


Fig. 14.

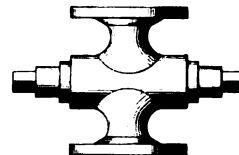
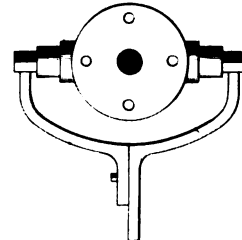
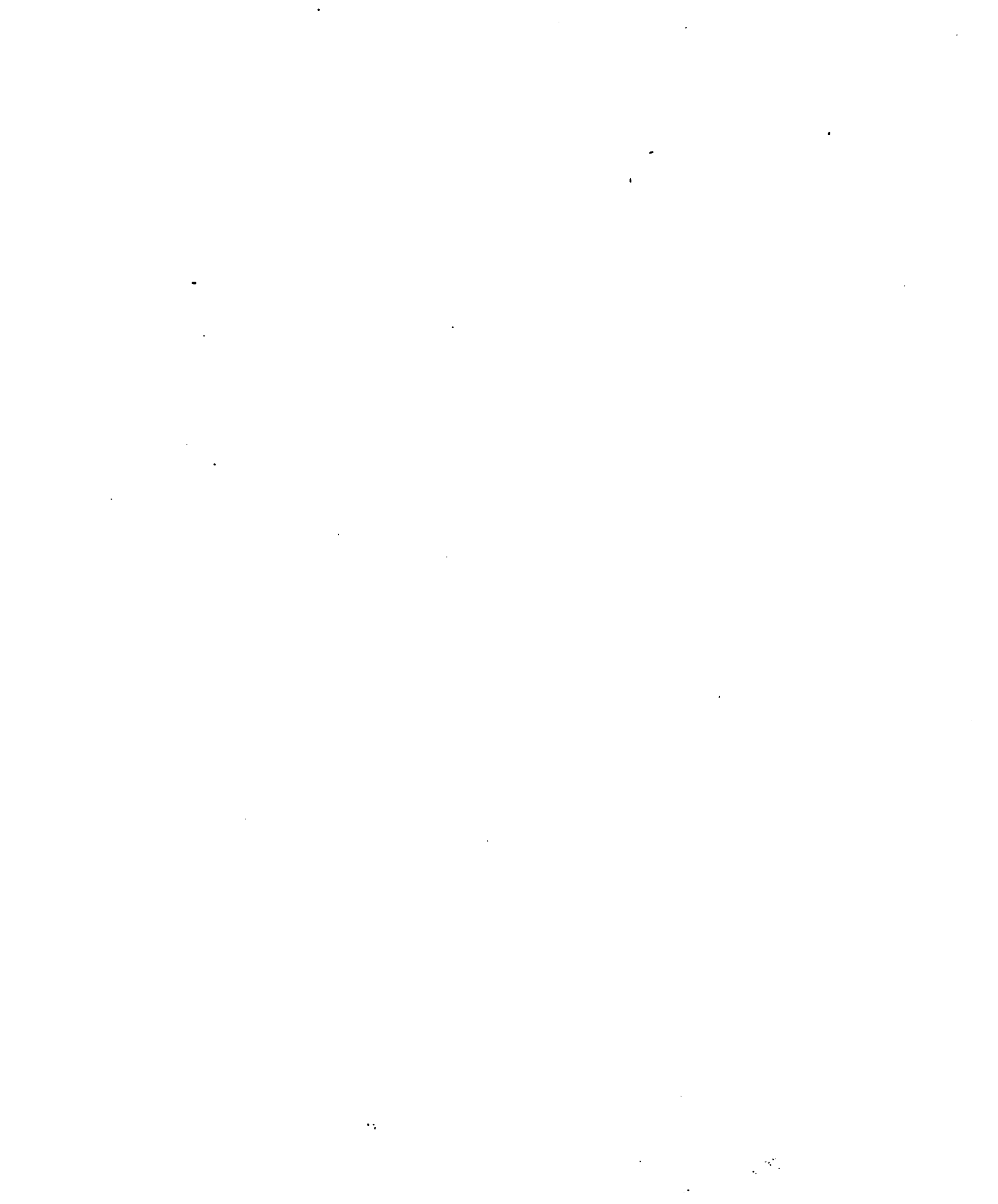
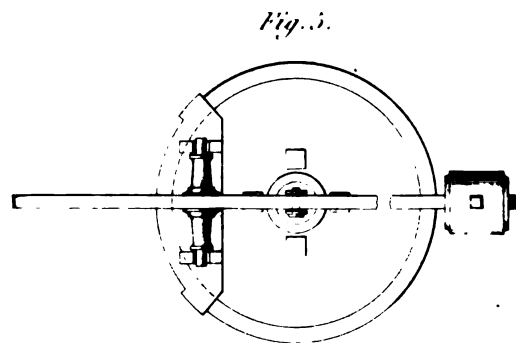
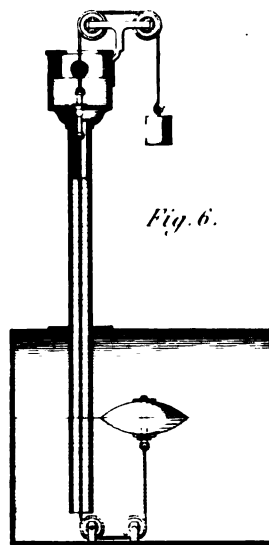
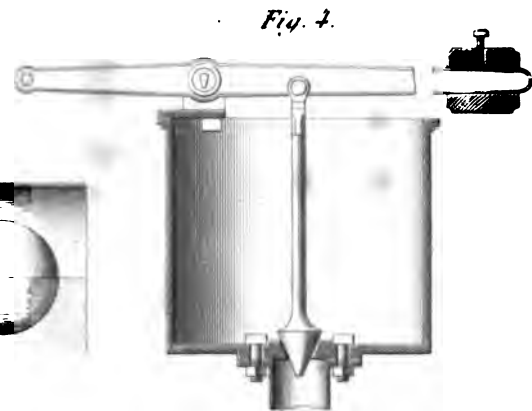
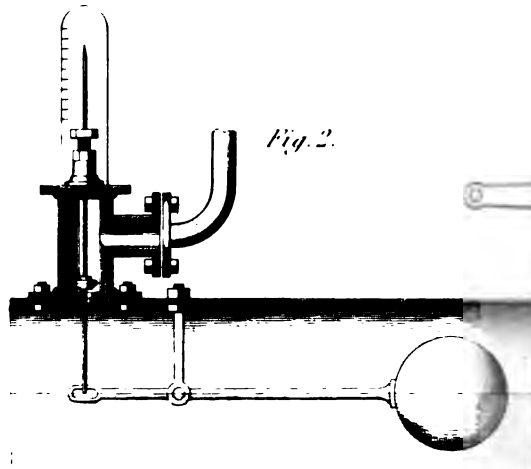
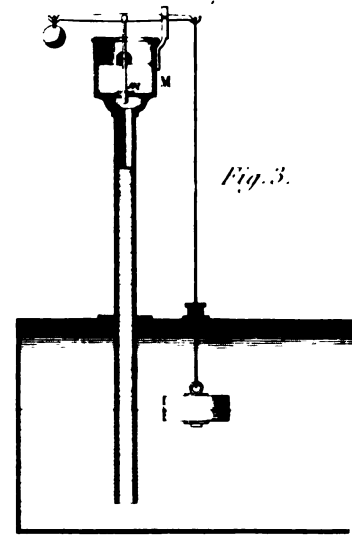
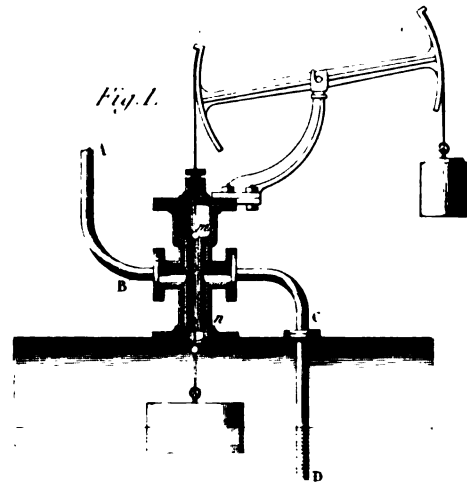


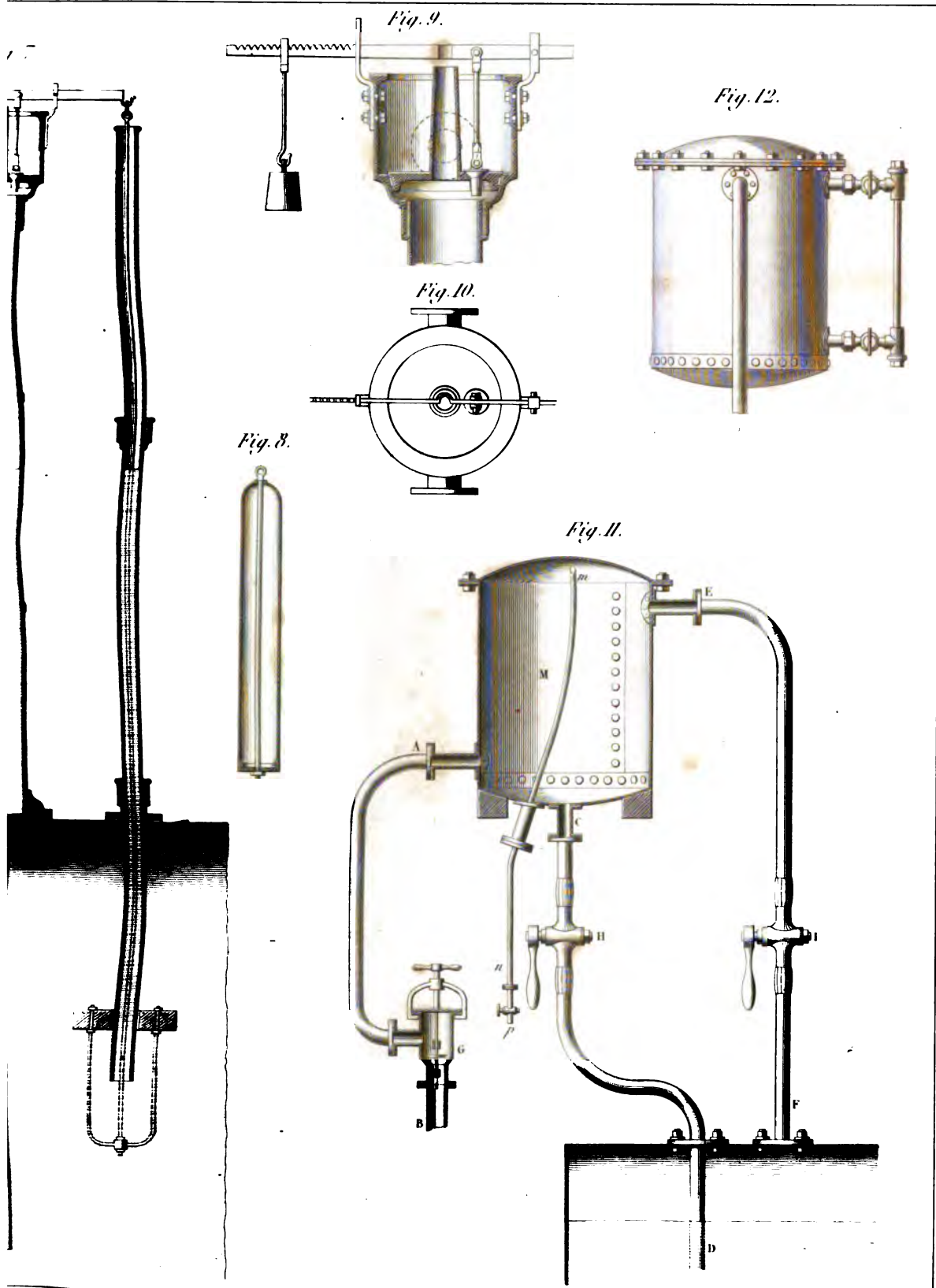
Fig. 15.





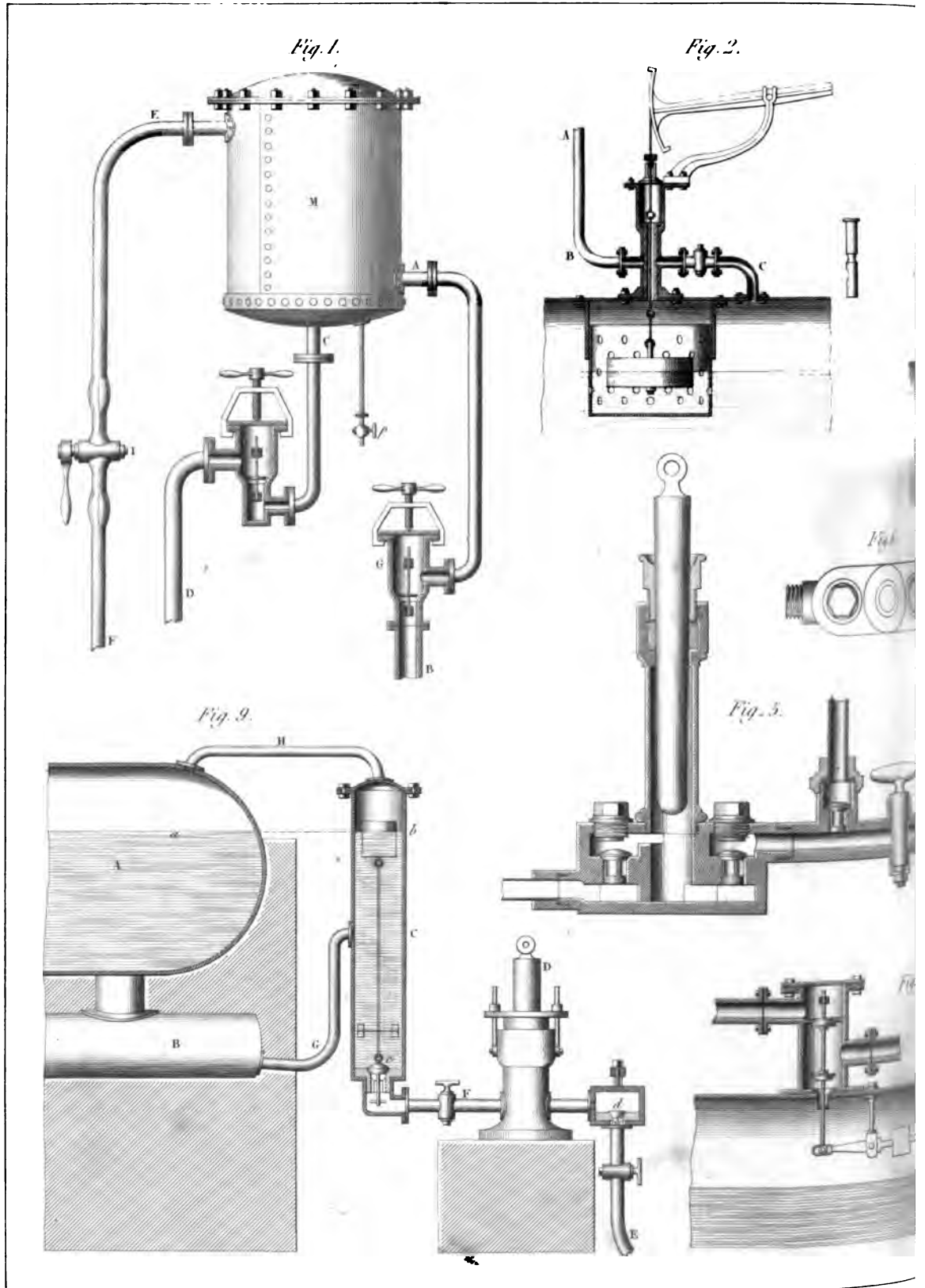


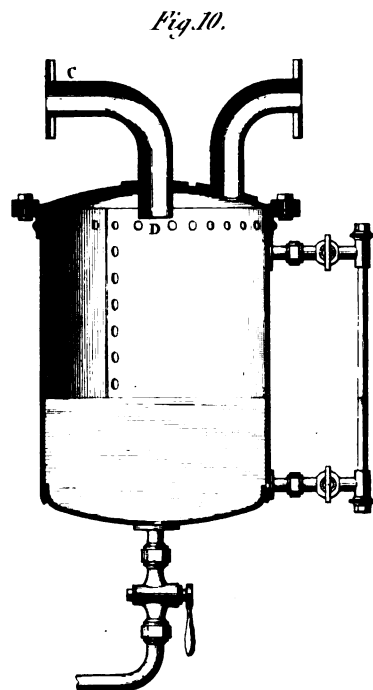
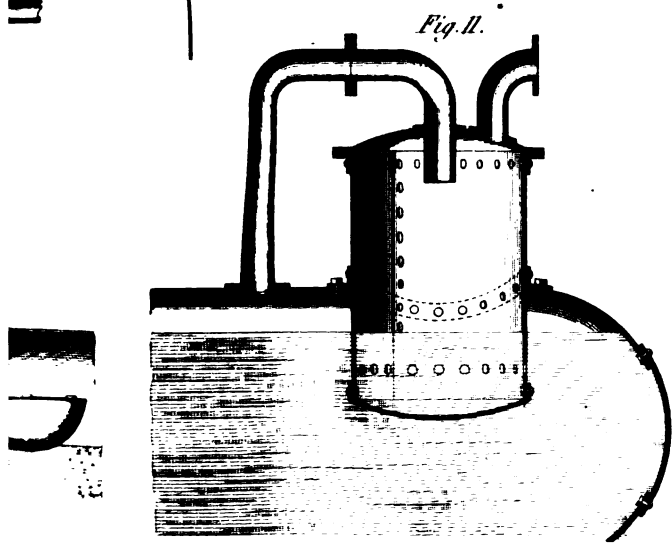
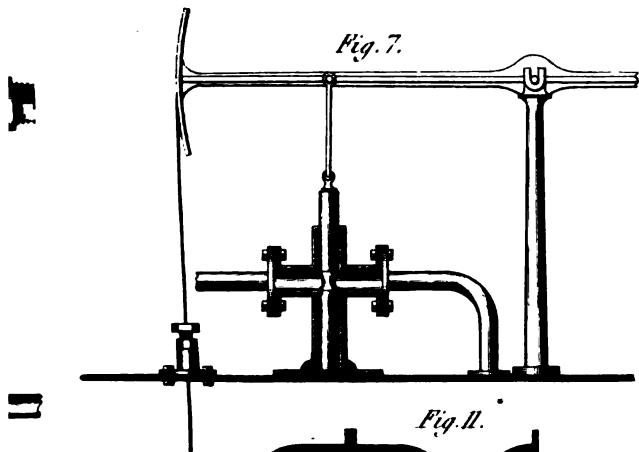
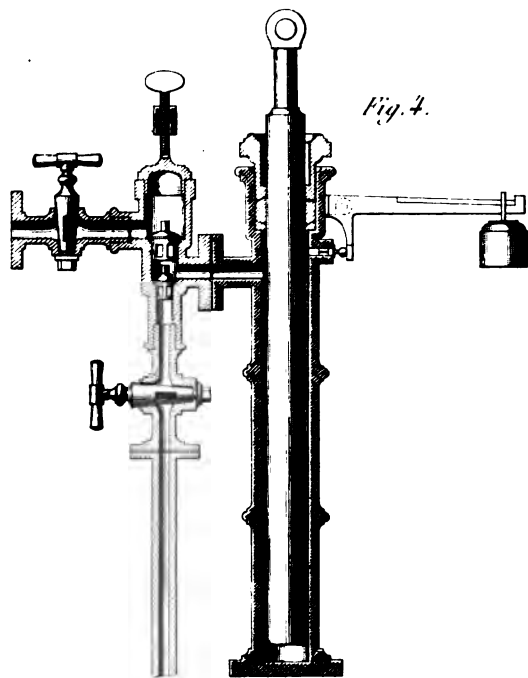
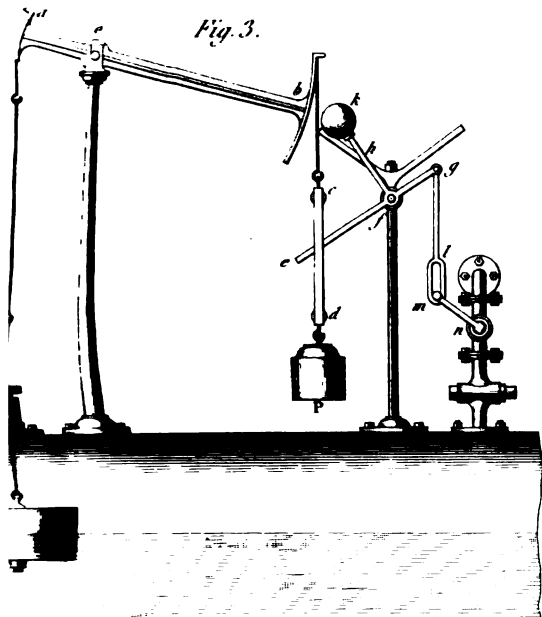


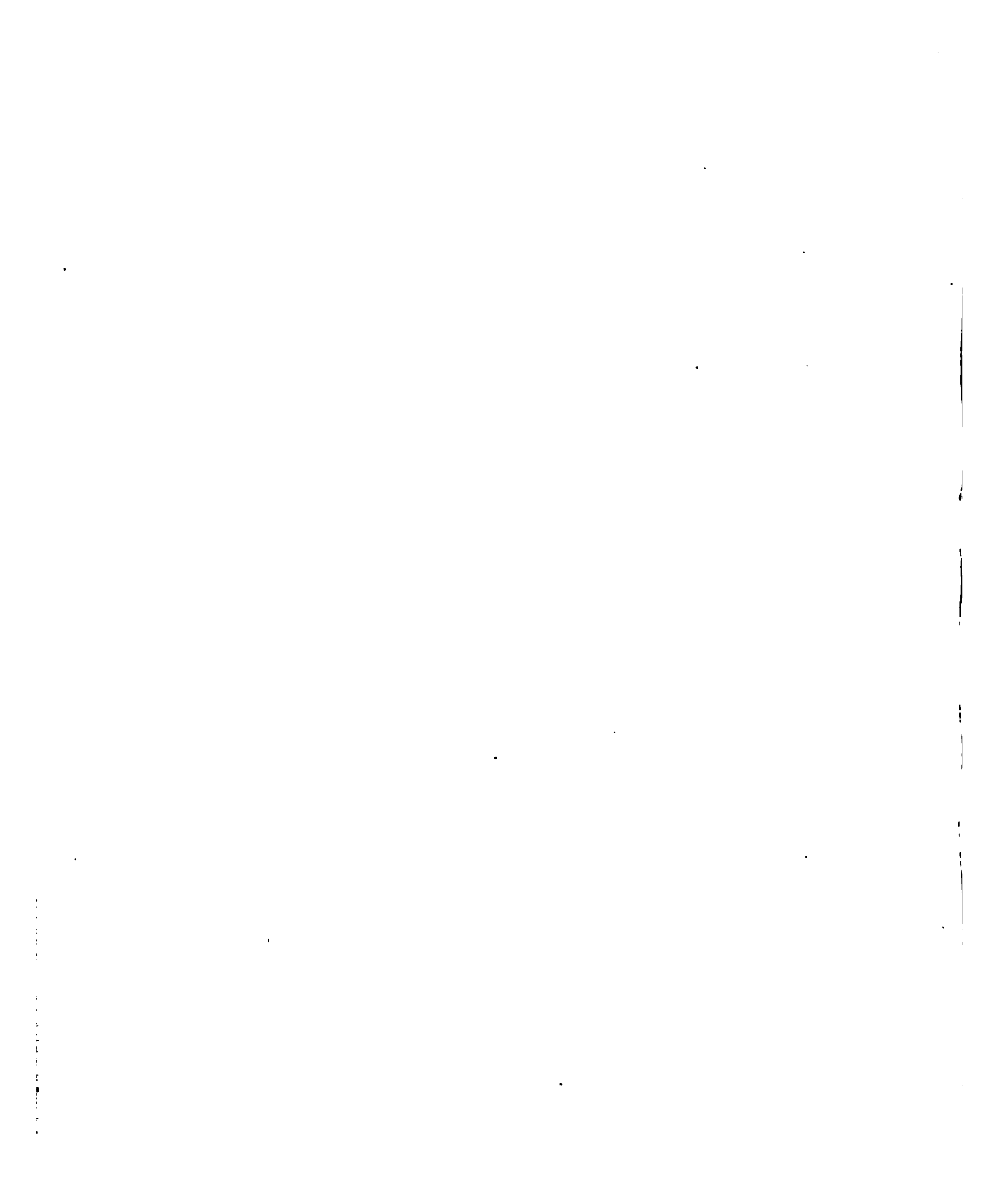


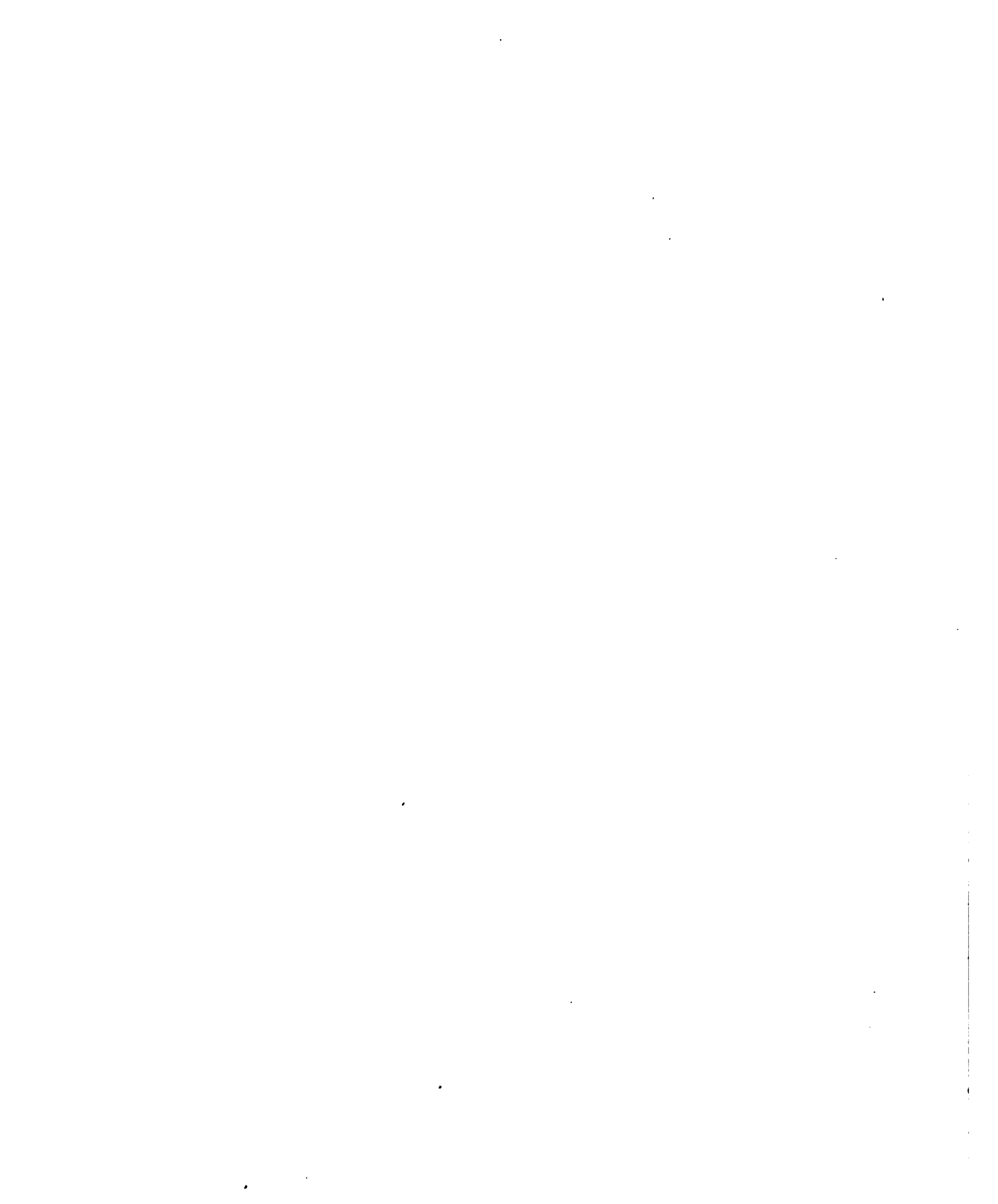












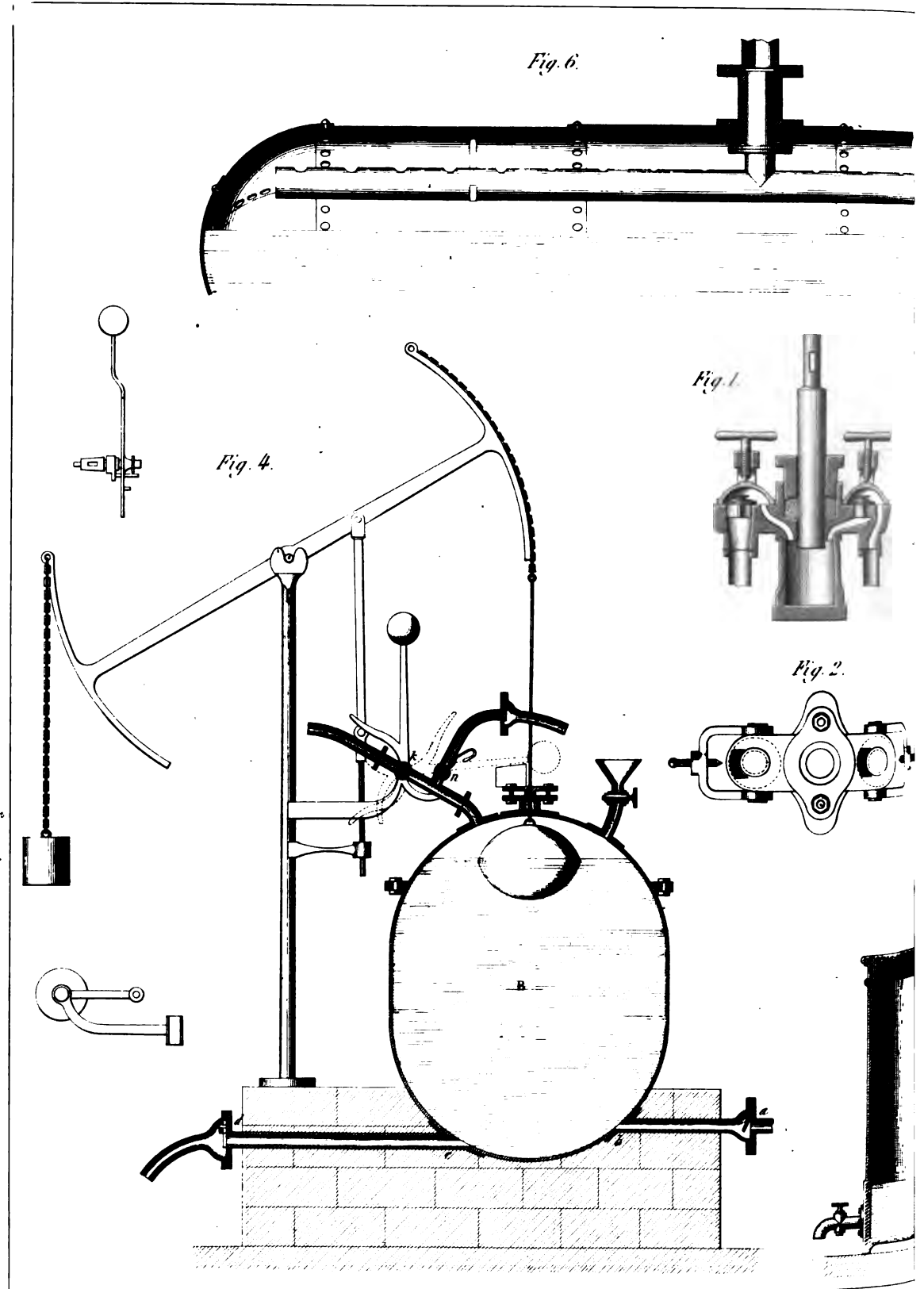


Fig. 7.

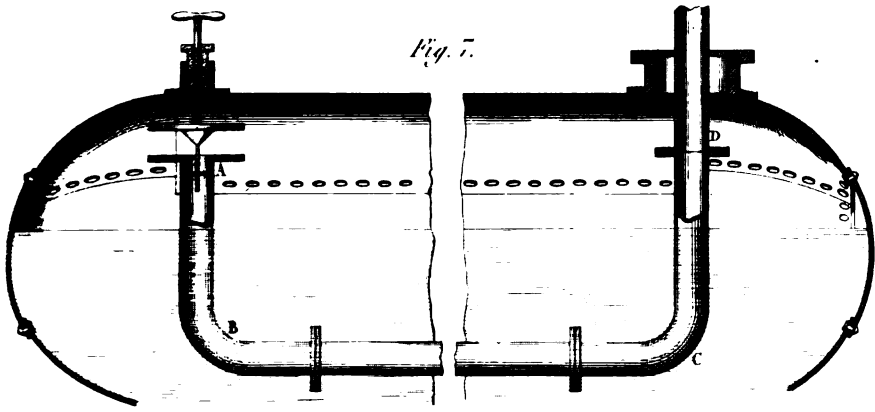


Fig. 3.

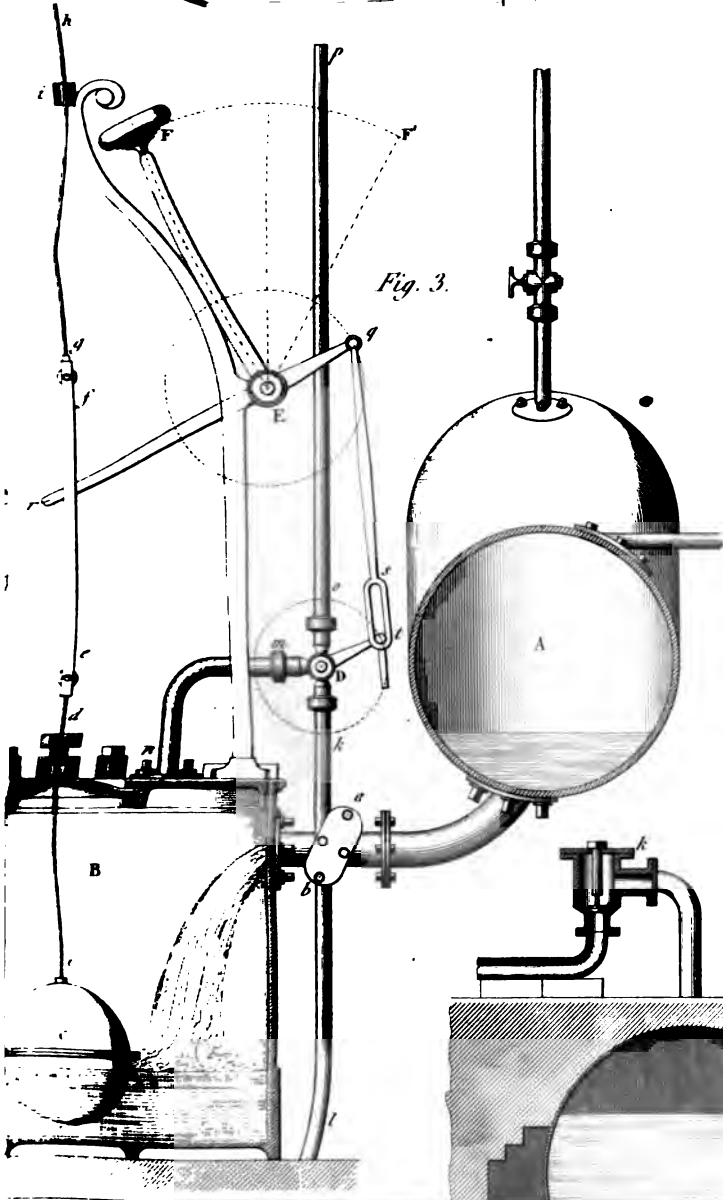


Fig. 5.

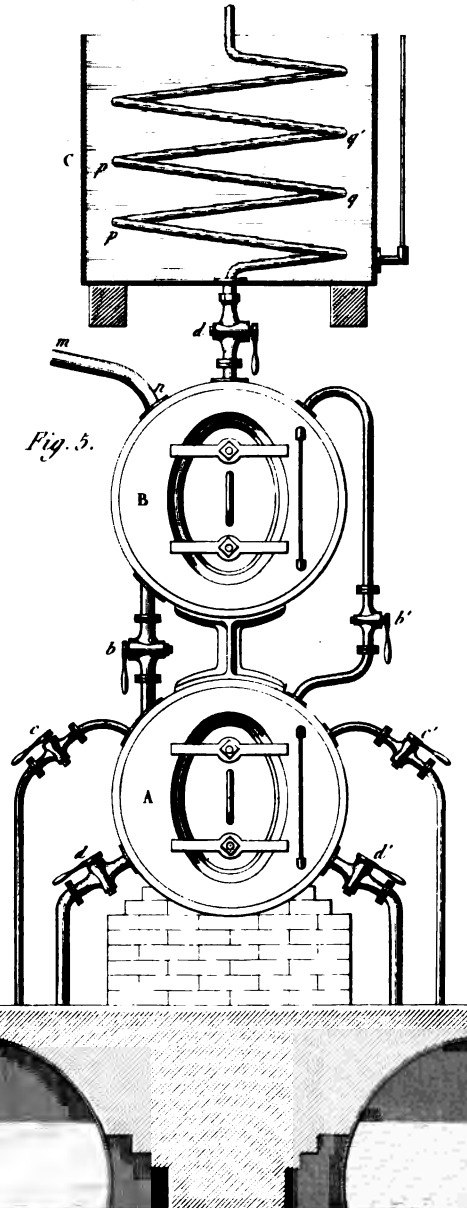




Fig. 1.

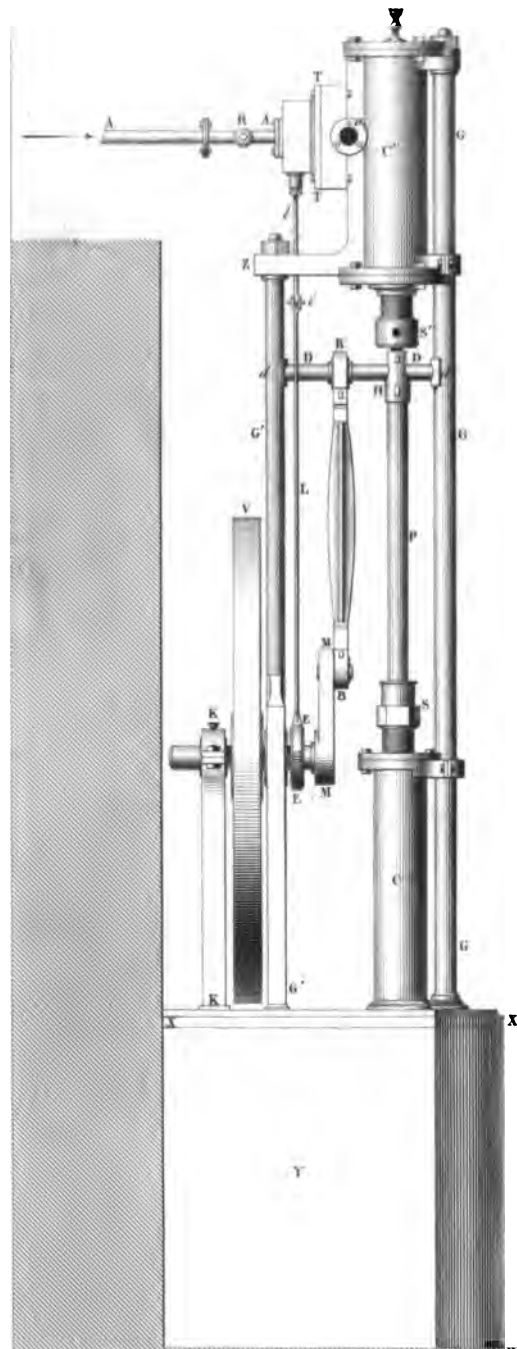
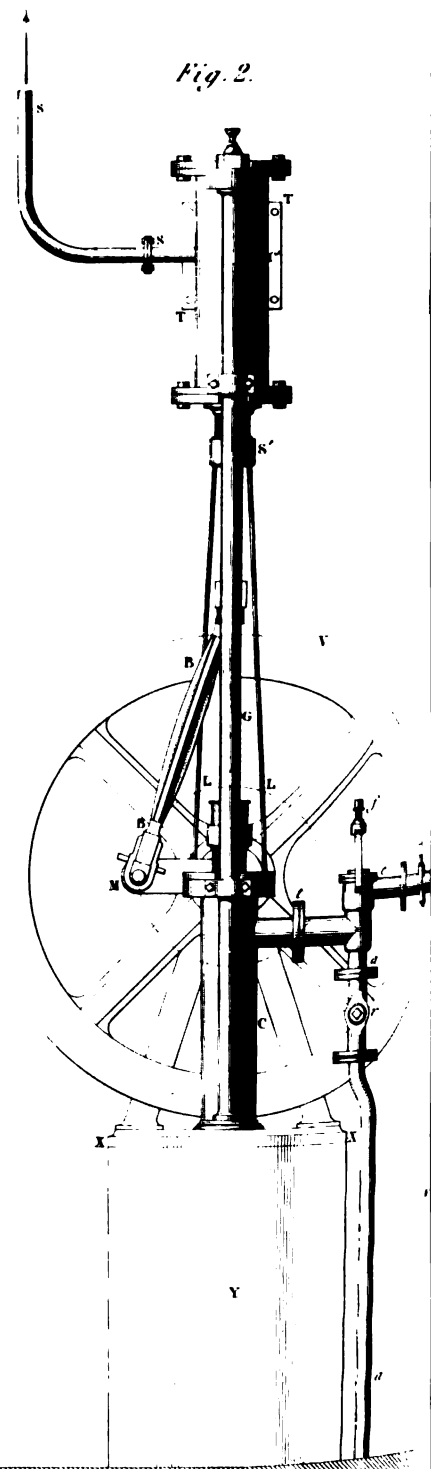


Fig. 2.



Echelle des Fig. 1 et 2.

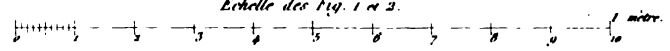


Fig. 4.

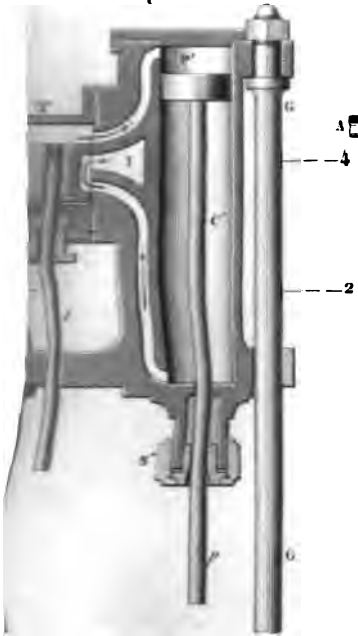


Fig. 5.

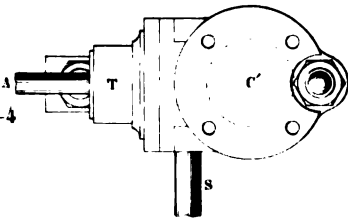


Fig. 6.

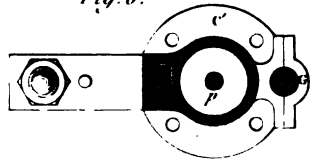


Fig. 7.

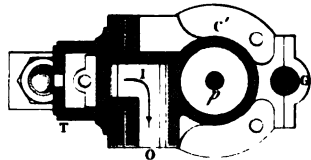


Fig. 9.

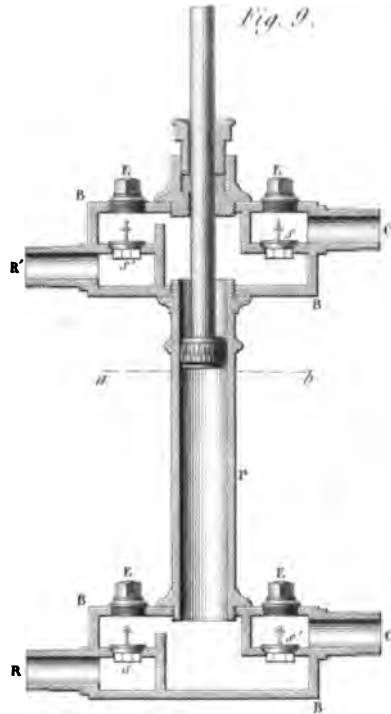


Fig. 3.

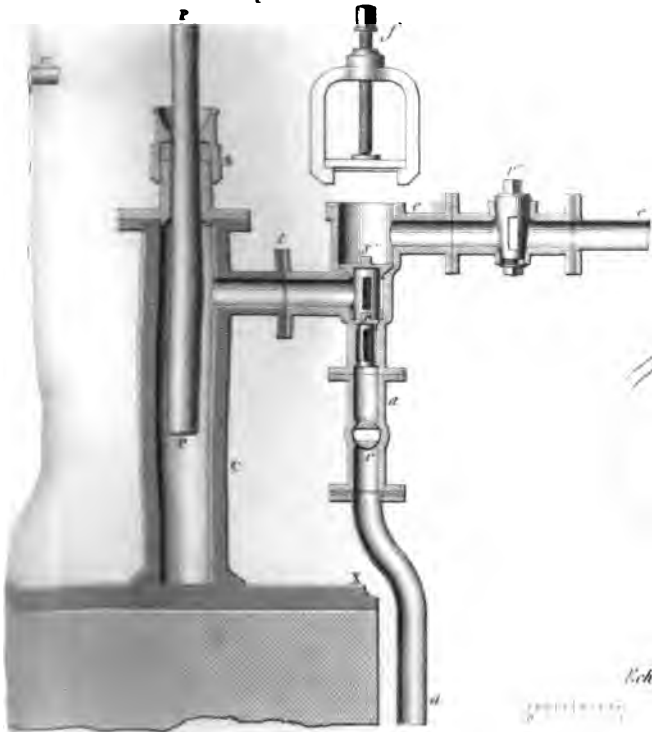
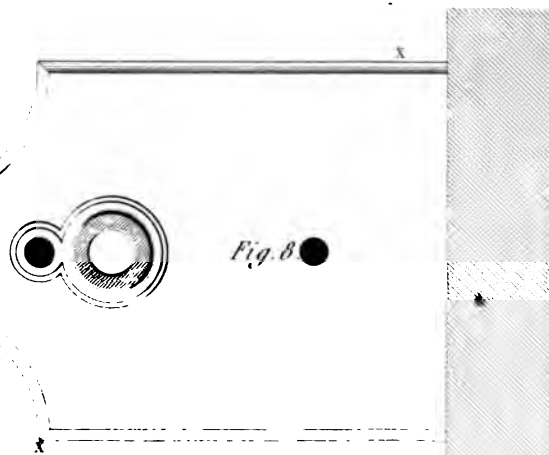


Fig. 10.

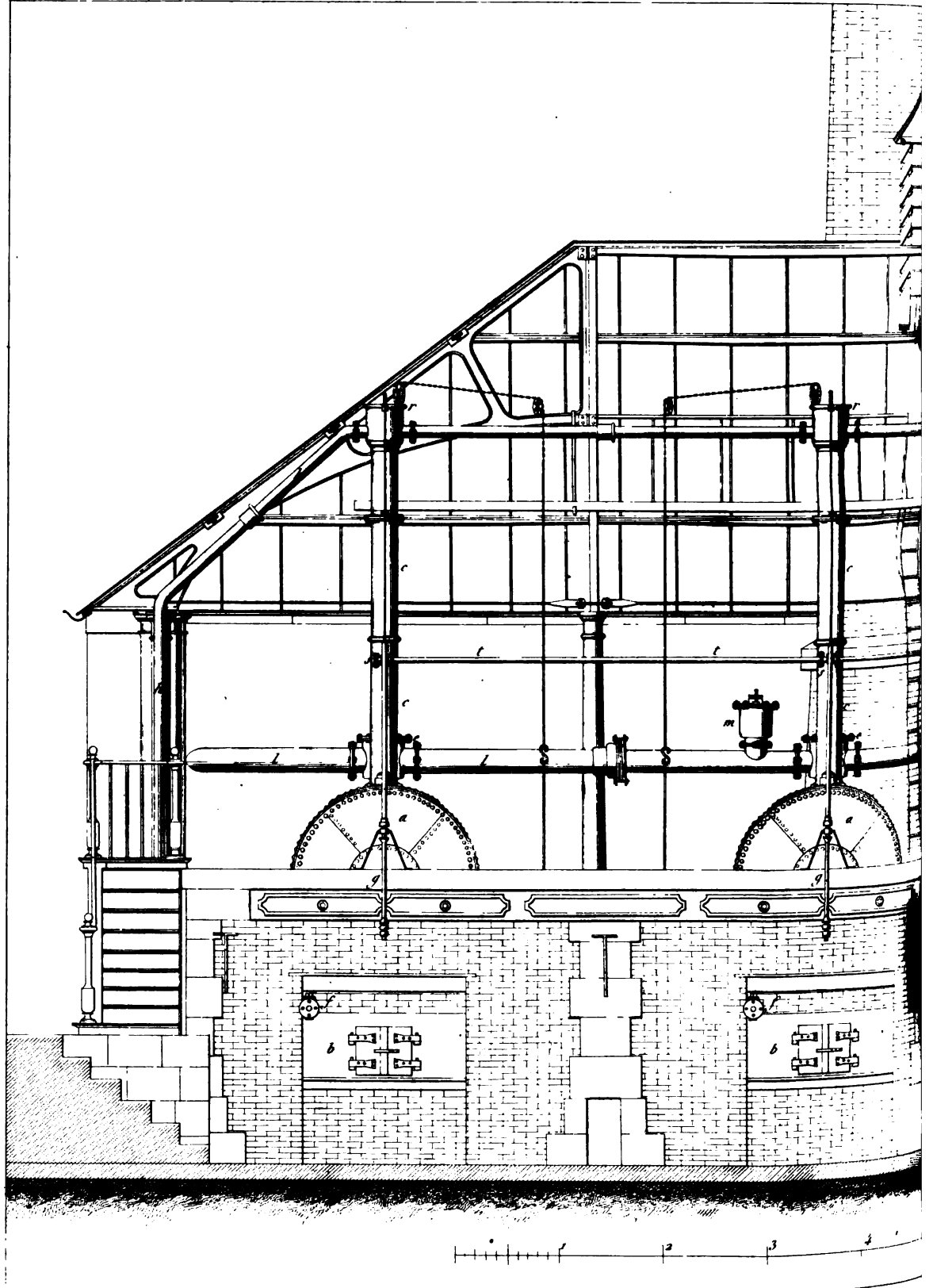


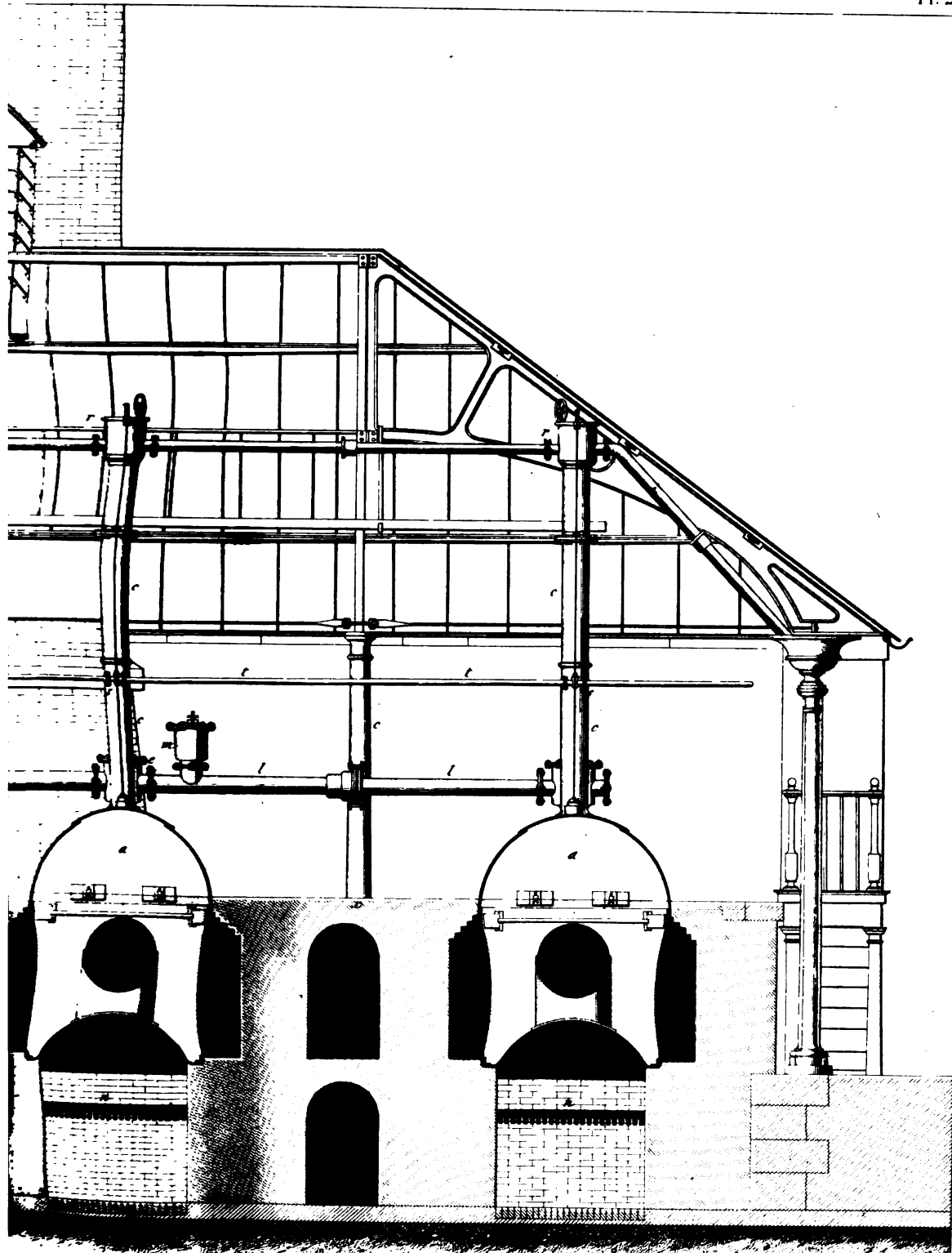
Fig. 8.



Échelle des Fig. 3, 4, 5, 6, 7, 10

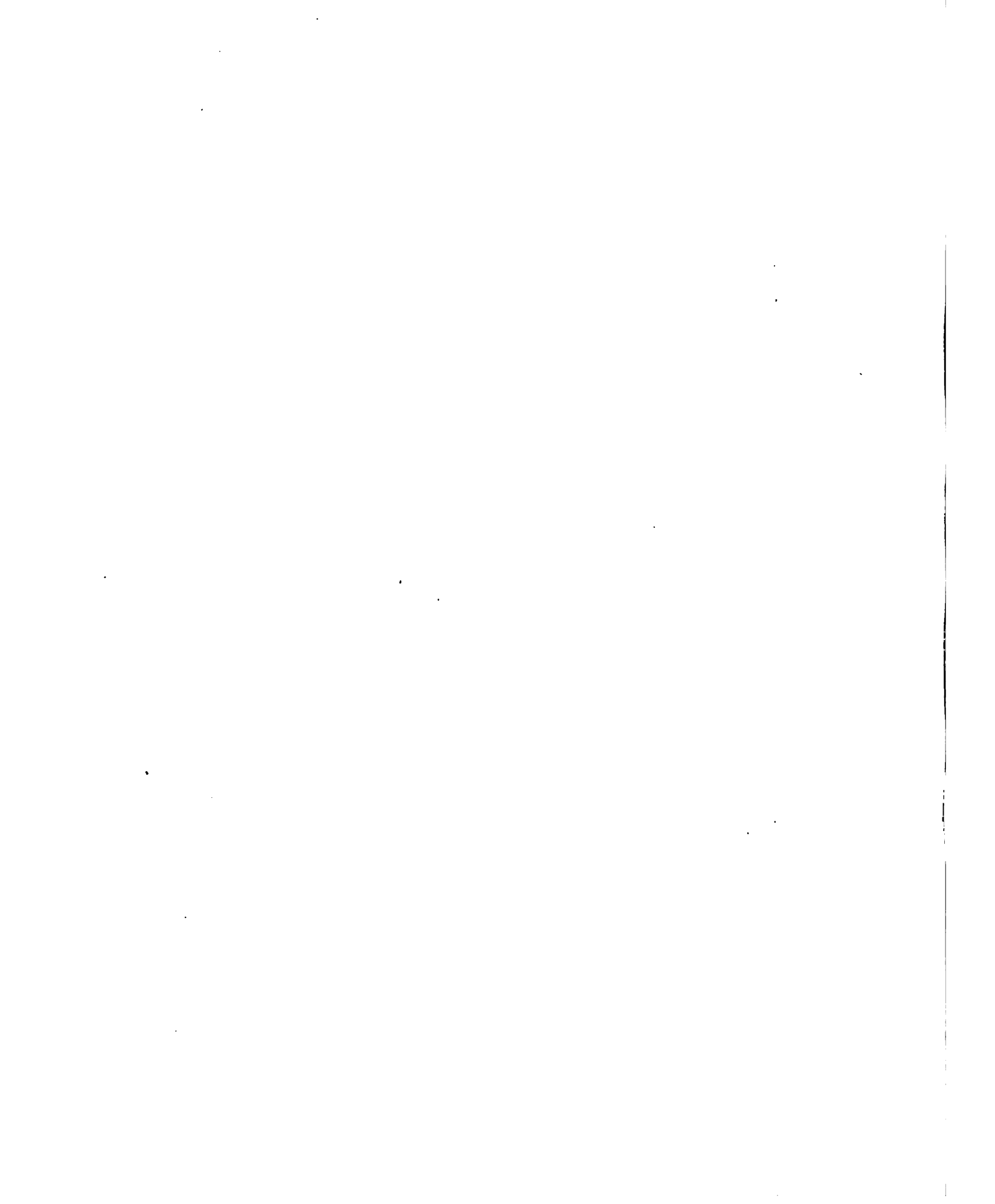
0 1 2 3 4 5 centimètres



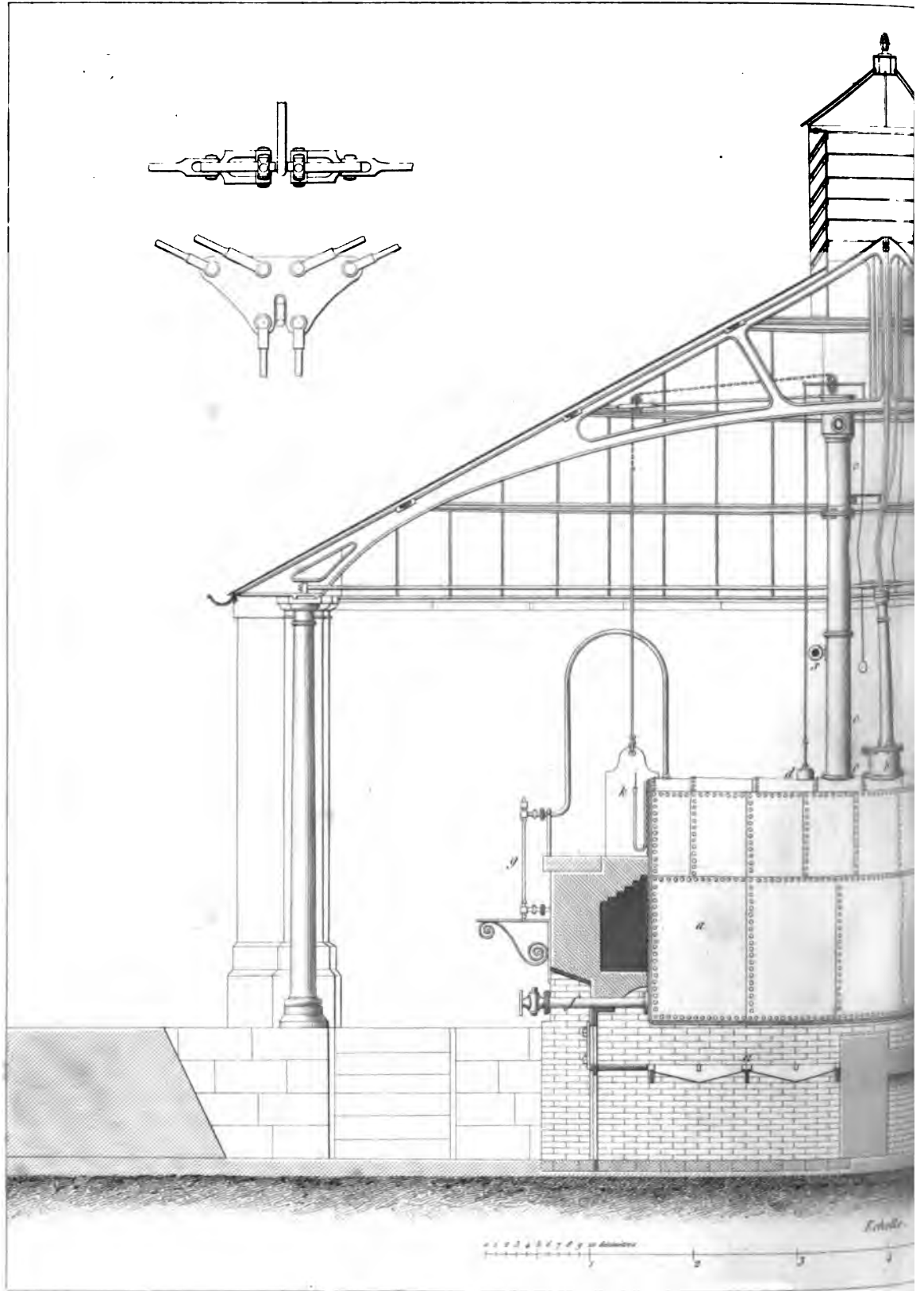


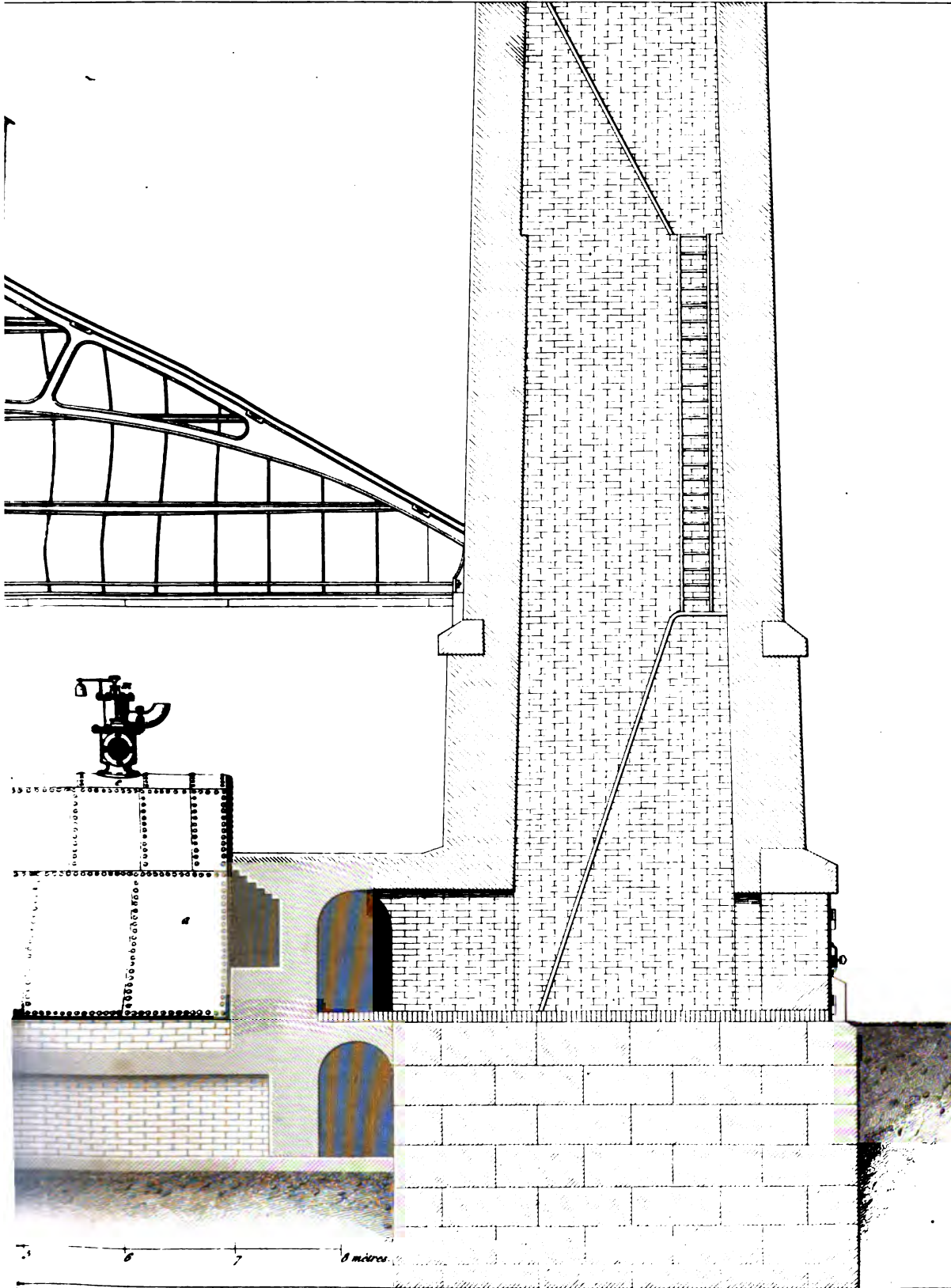
6 7 8 9 10 mètres.

Gravé par Durau.

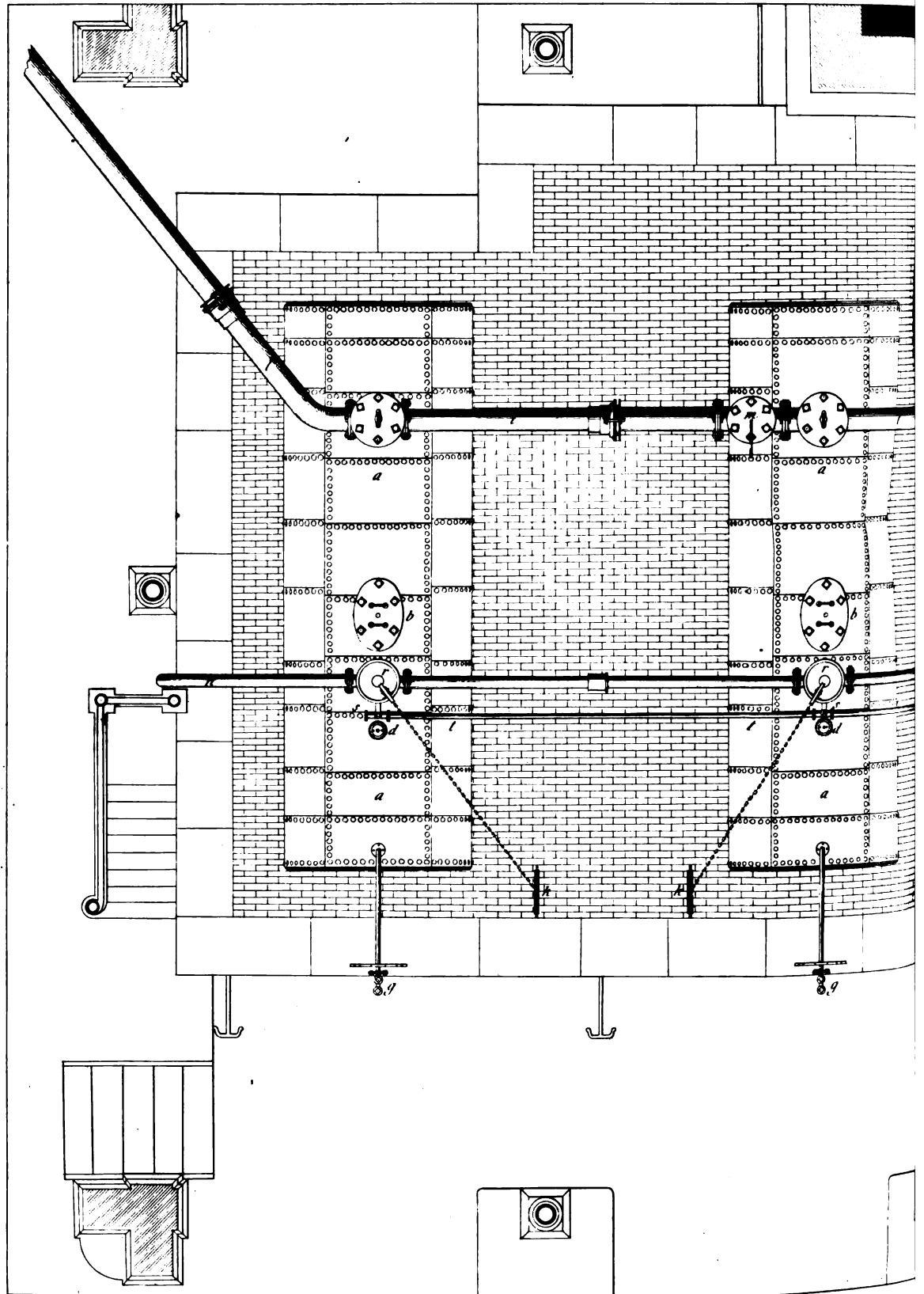


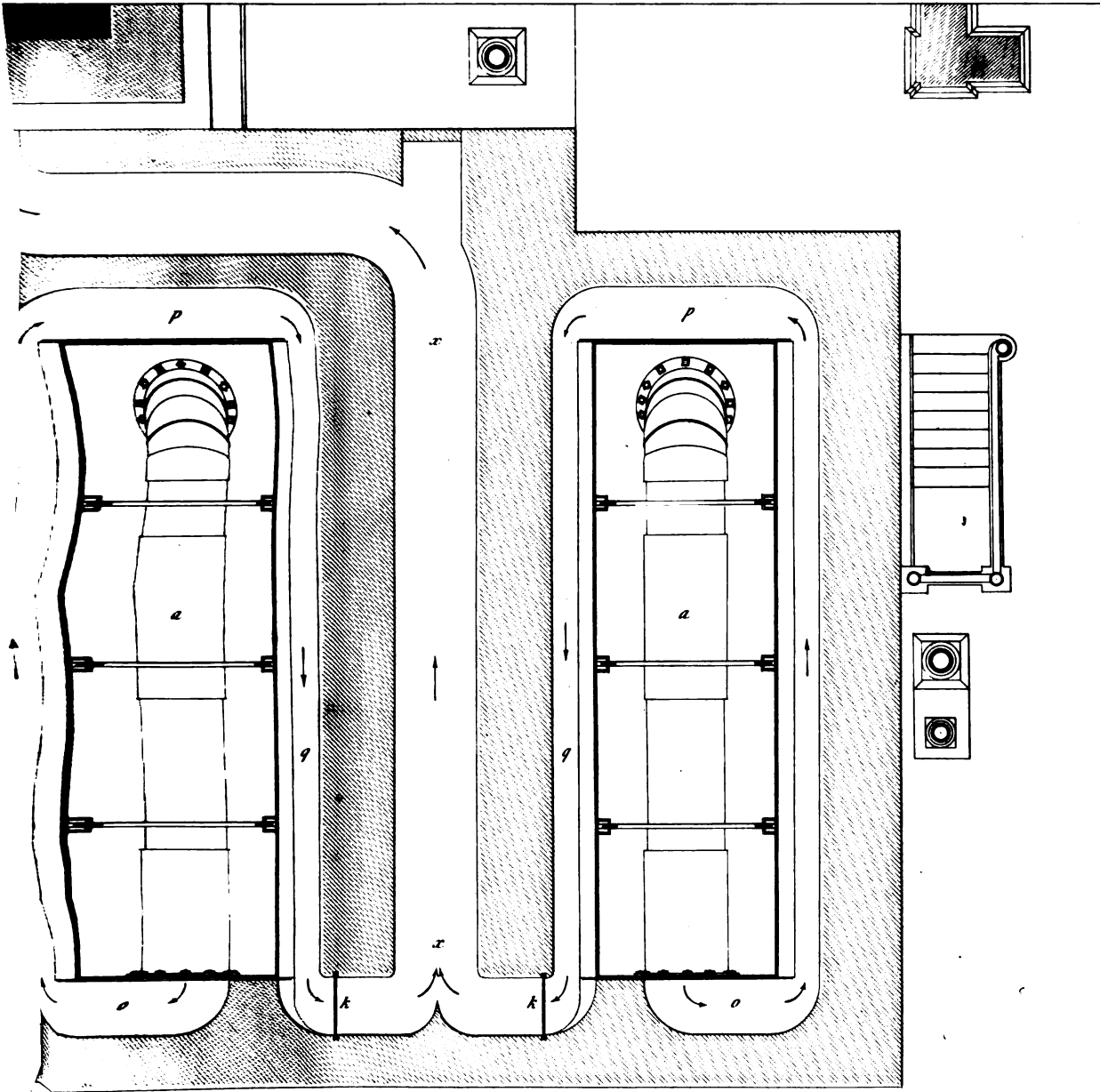












Echelle.



Gravé par Duran

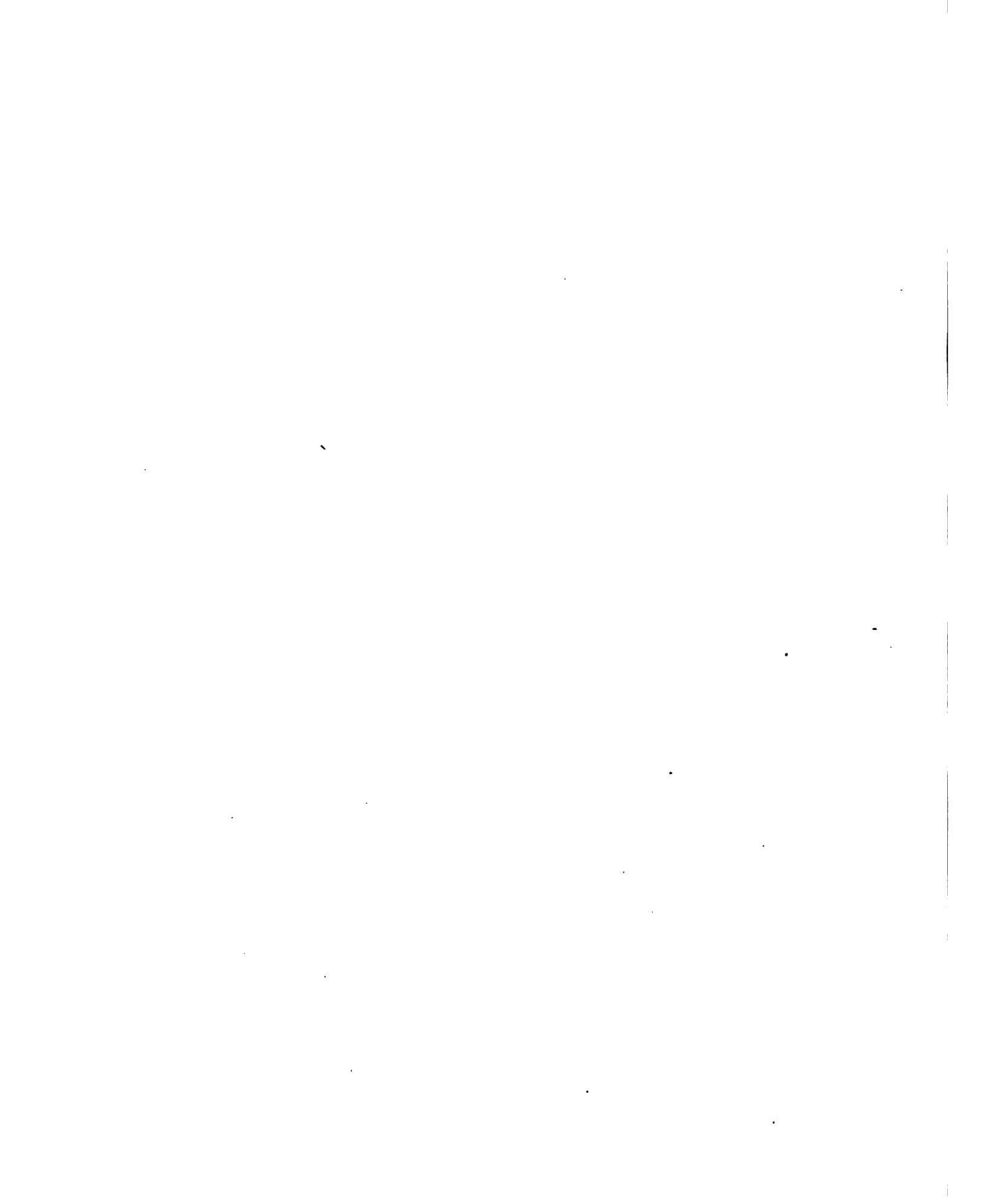




Fig. 1.

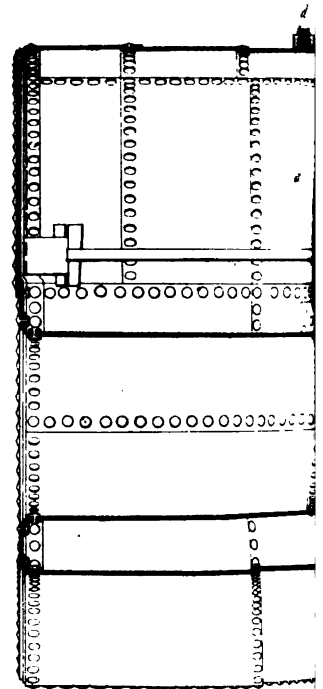
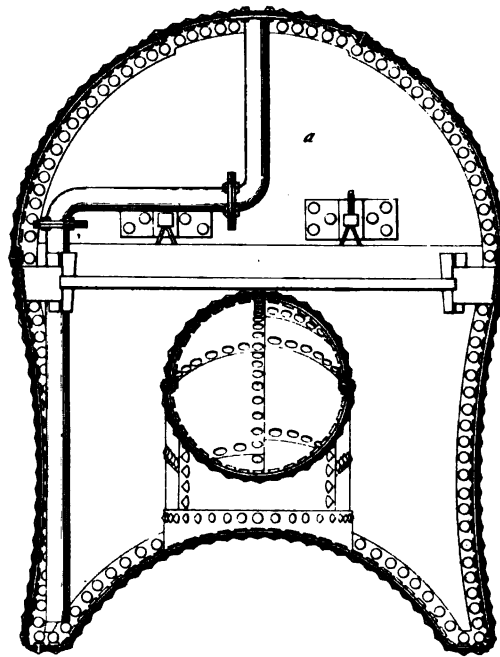


Fig. 17.

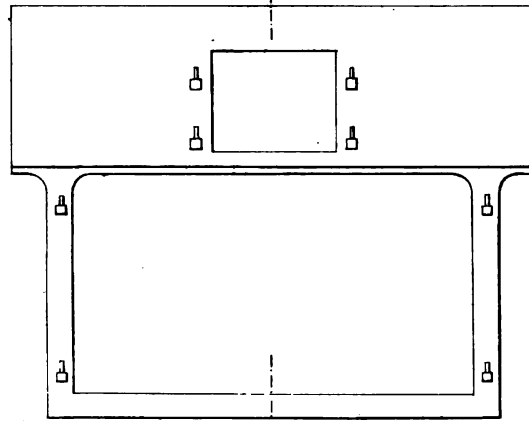


Fig. 18.

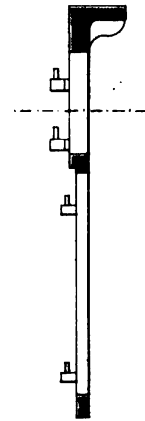


Fig. 20.

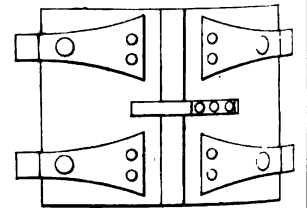


Fig. 22.

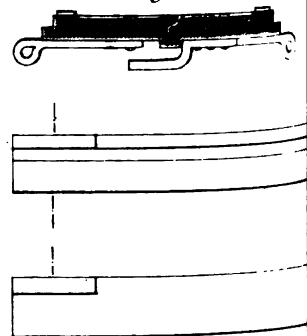
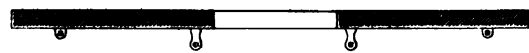
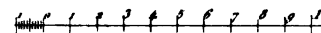


Fig. 19.



Echelle des Fig. 1, 2, 17, 18 et 19.



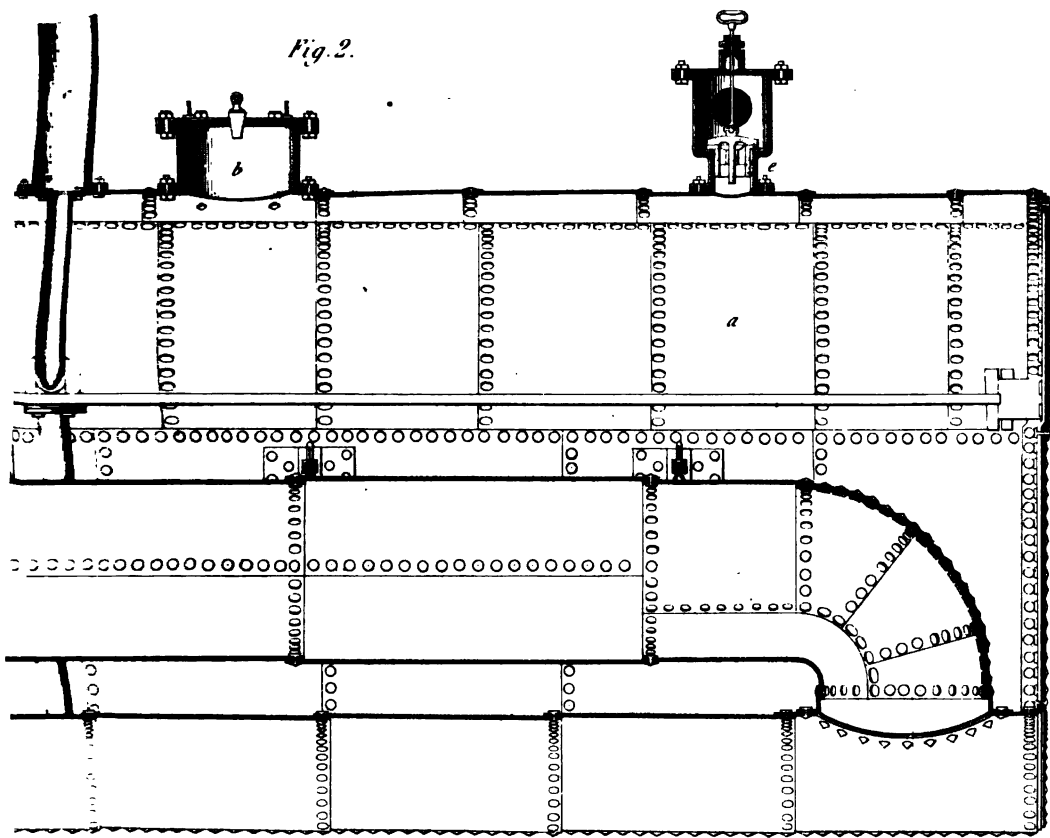


Fig. 21.

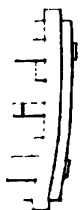


Fig. 6.

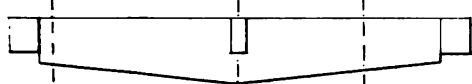


Fig. 7.



Fig. 8.



Fig. 9.



Fig. 10.



Fig. 3.



Fig. 4.

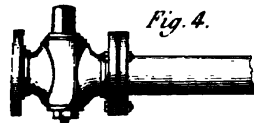


Fig. 5.

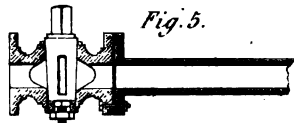


Fig. 11.

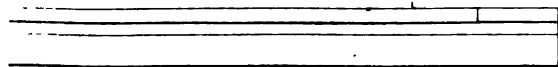


Fig. 12.

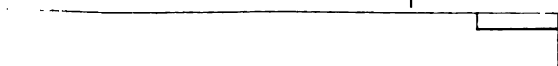


Fig. 13.



Fig. 14.



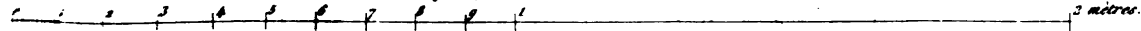
Fig. 15.



Fig. 16.



Echelle des Fig. 6, 7, 8, 15, 16, 20, 21 et 22.



3 mètres.

Inventé par Duran.



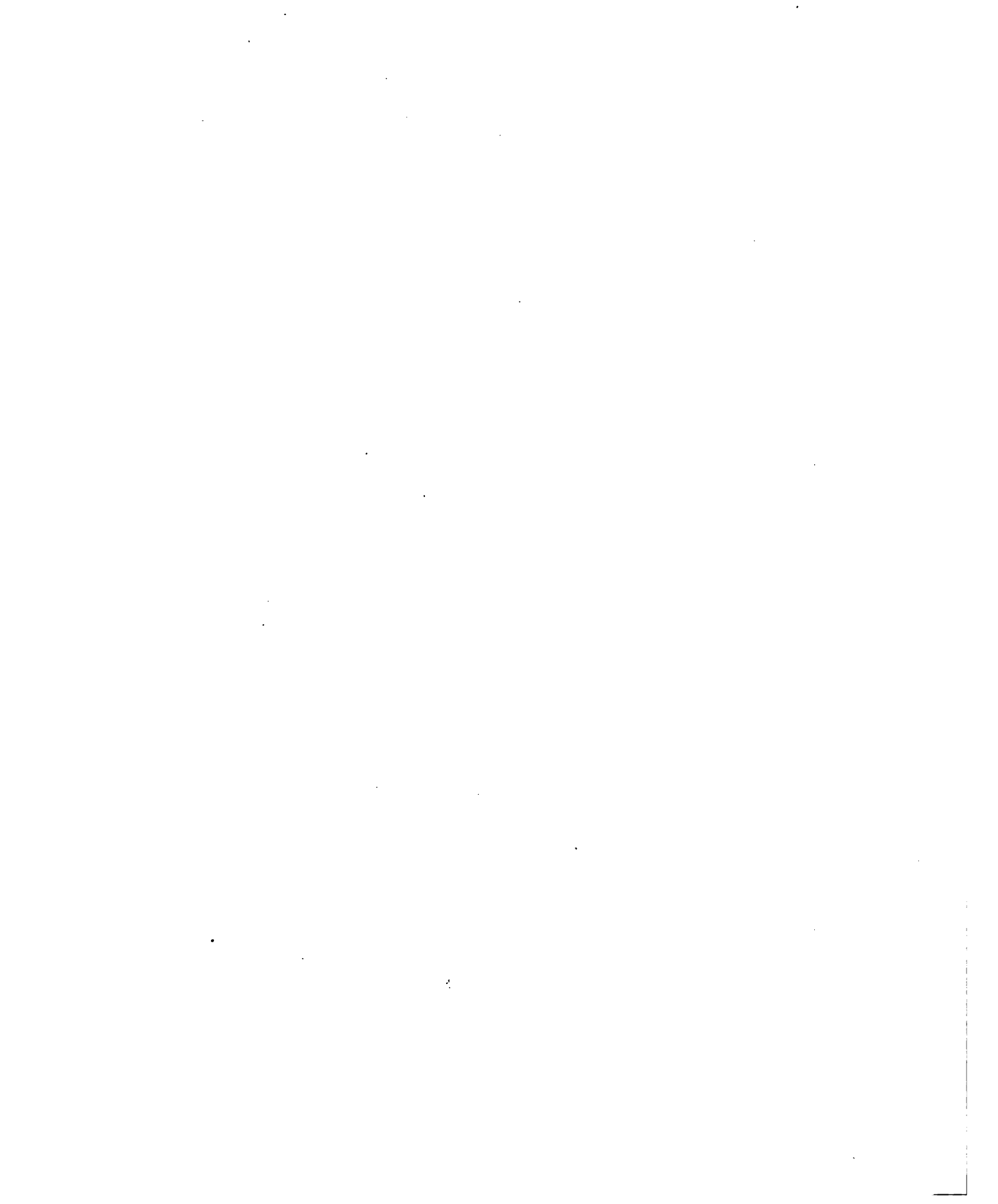


Fig. 1.

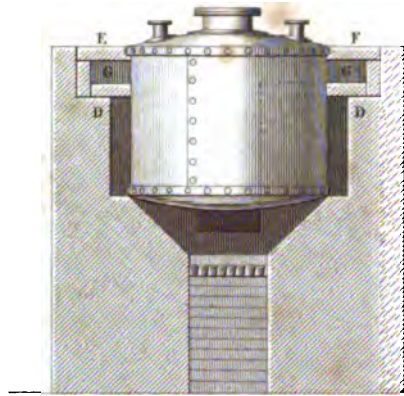


Fig. 2.

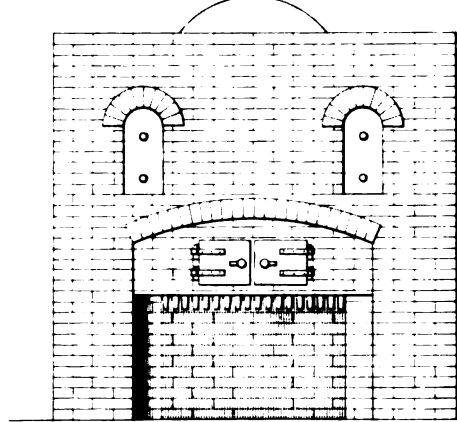


Fig. 6.

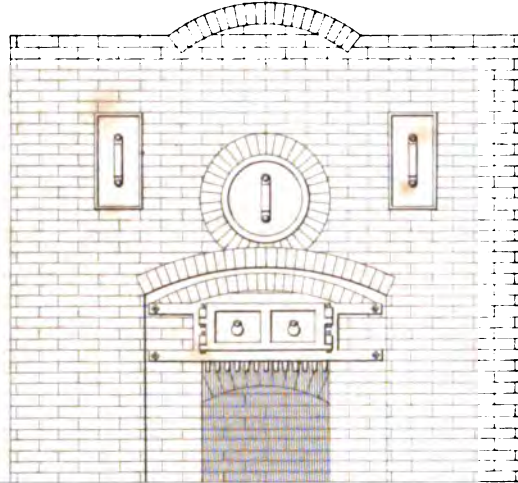


Fig. 7.

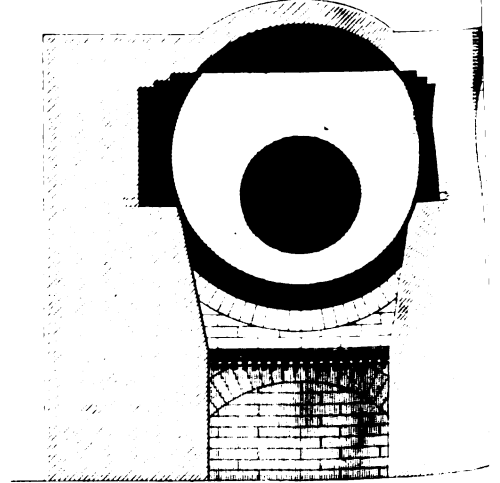


Fig. 10.

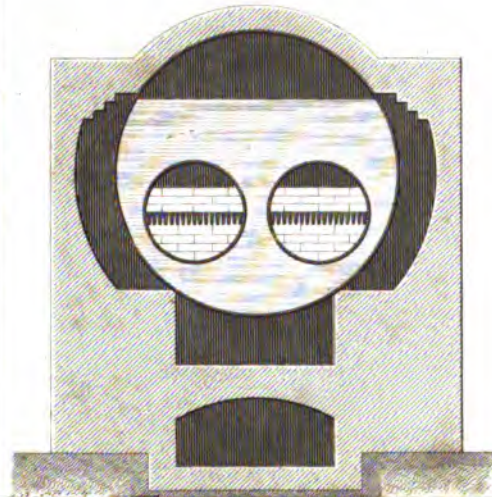


Fig. 11.

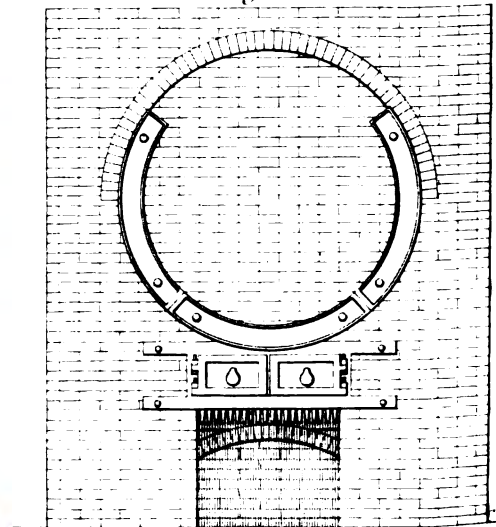


Fig. 4.

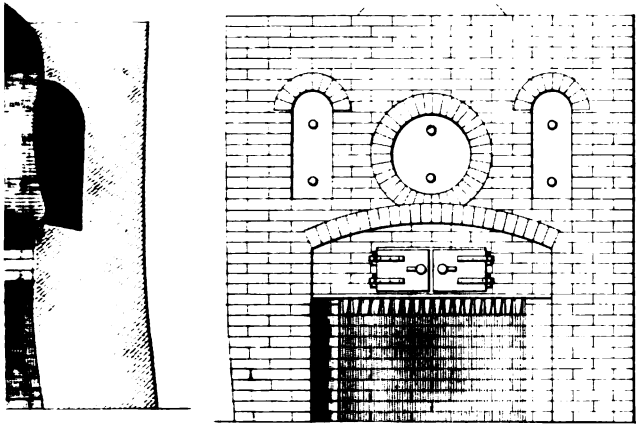


Fig. 5.

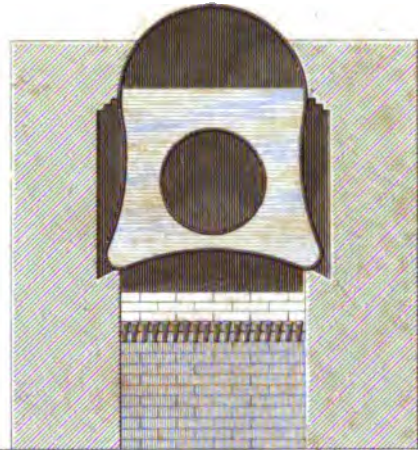


Fig. 8.

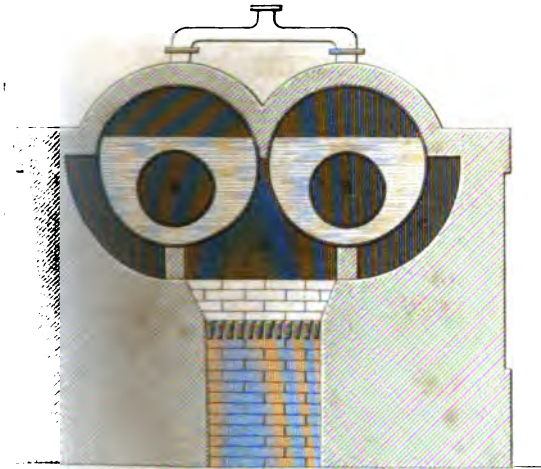


Fig. 9.

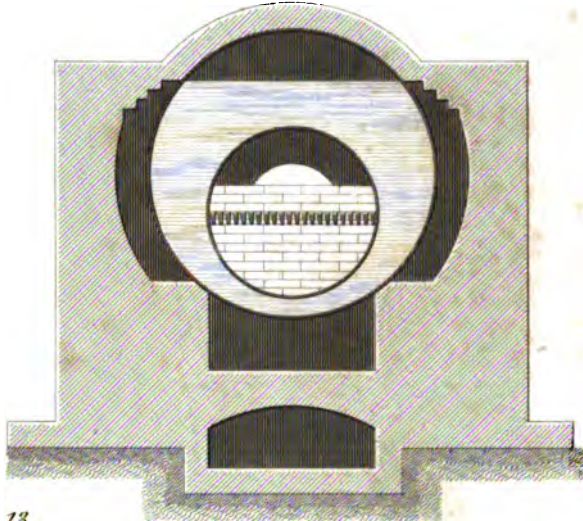


Fig. 12.

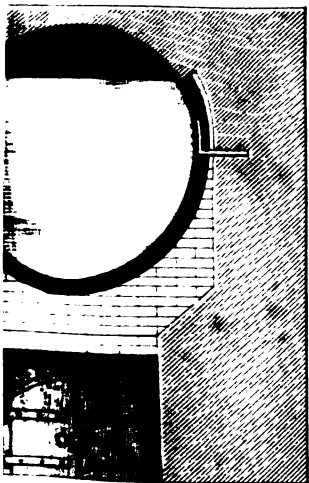


Fig. 13.

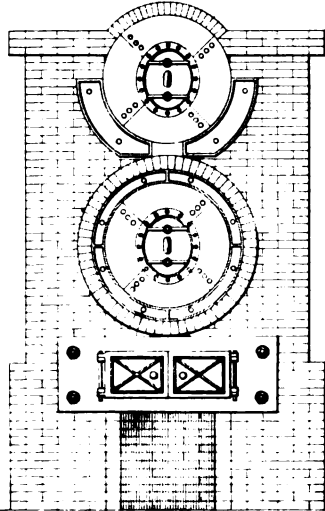
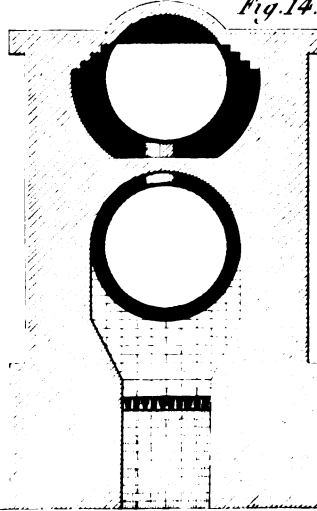
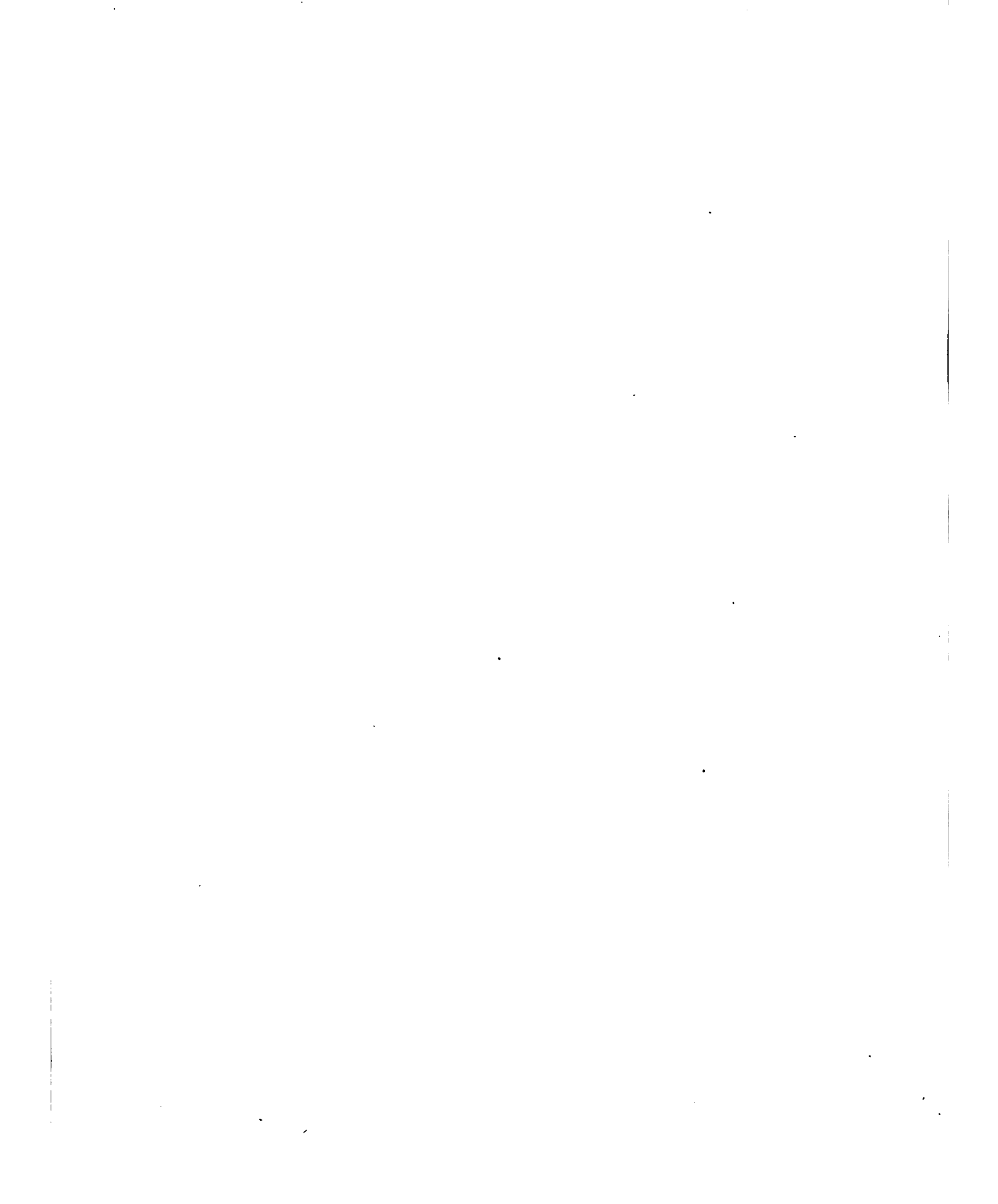
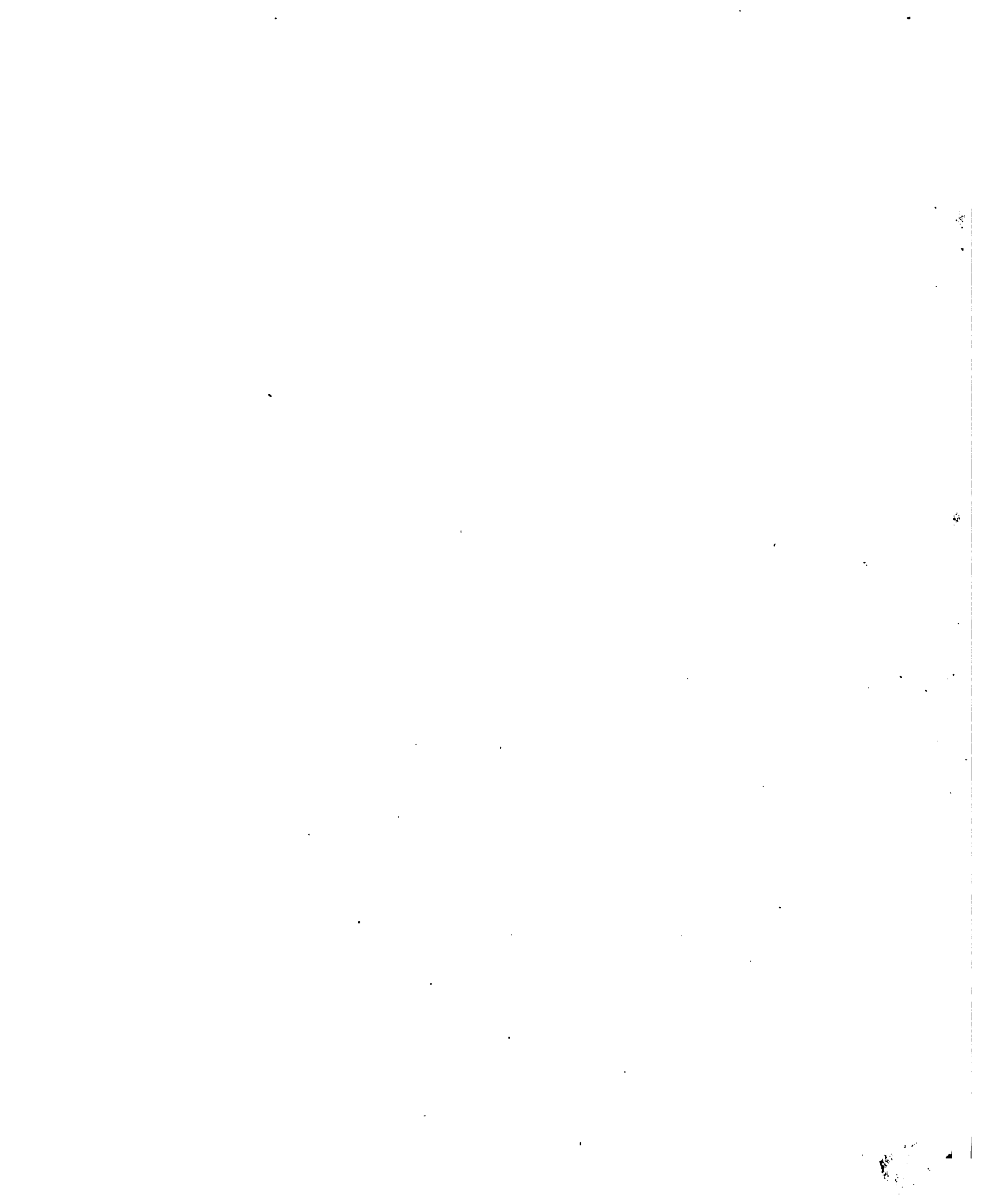


Fig. 14.







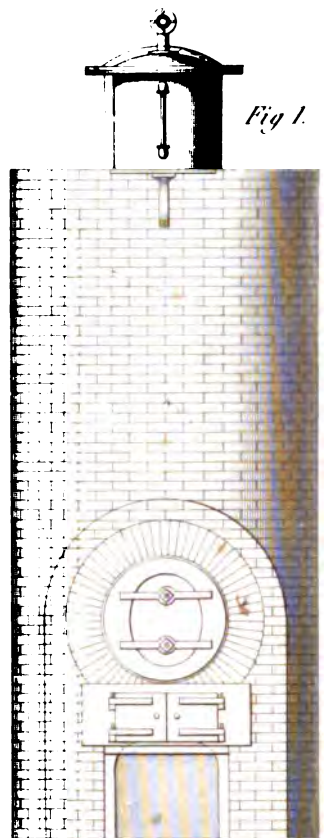


Fig. 1.

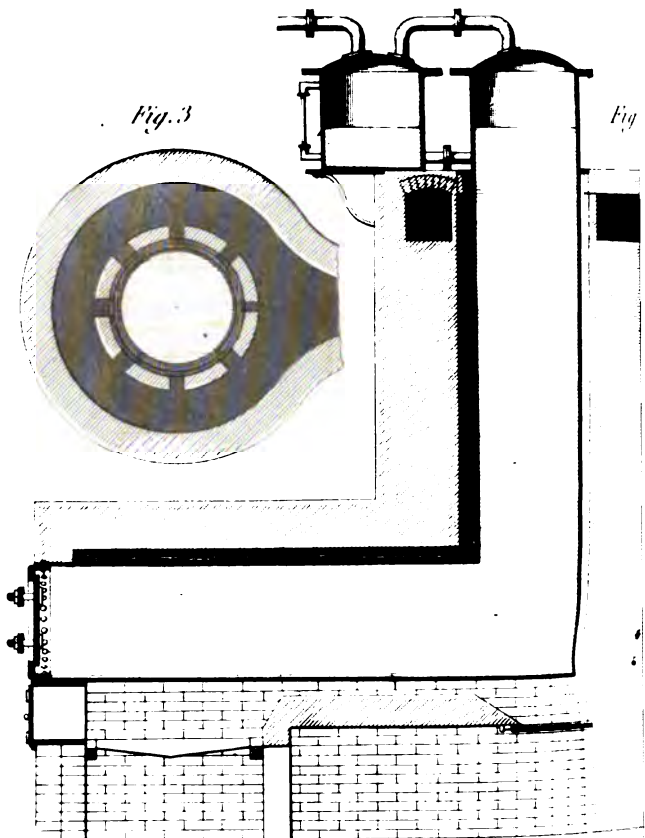


Fig. 3.

Fig.

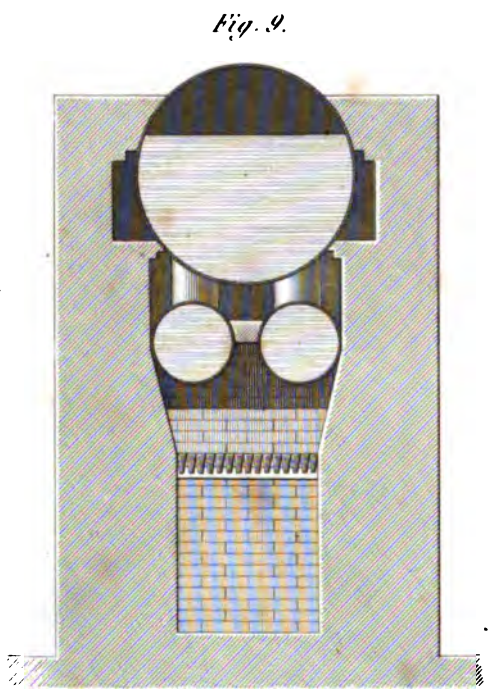


Fig. 9.

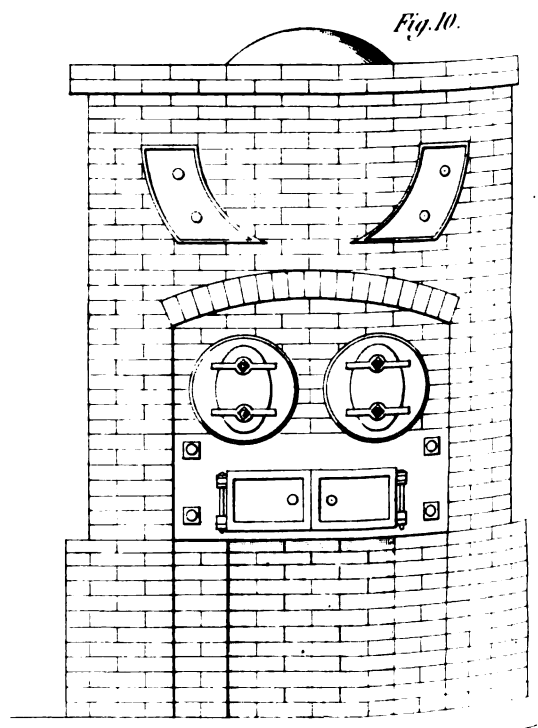
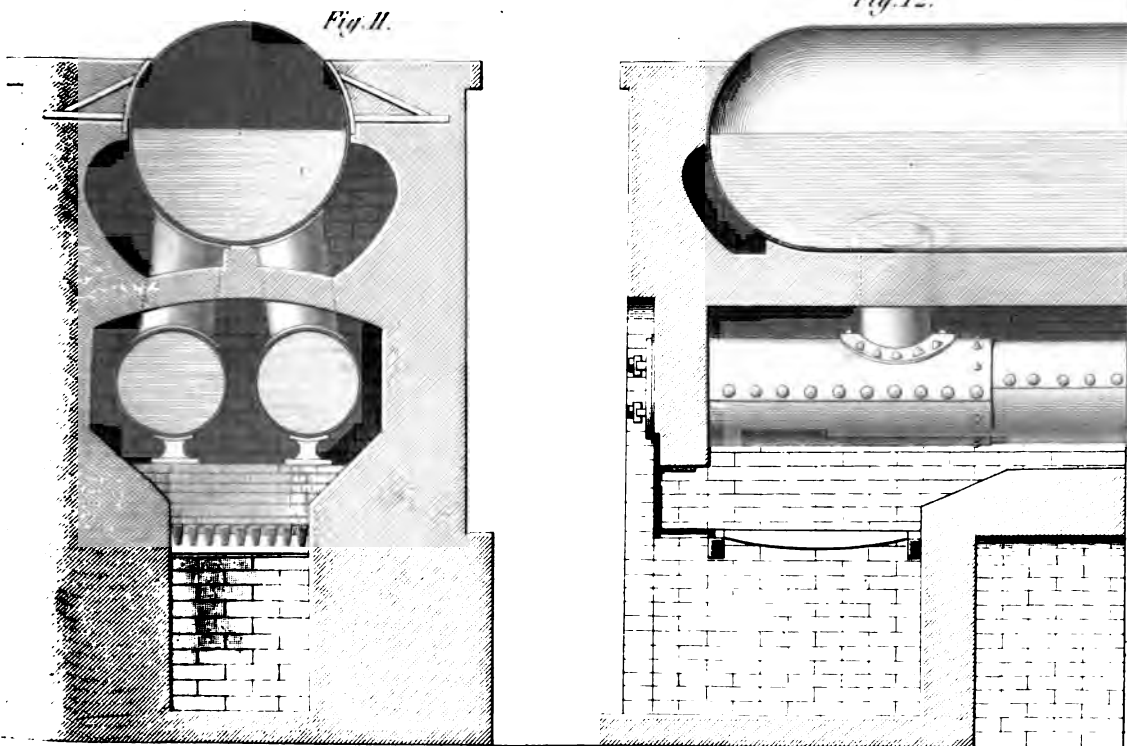
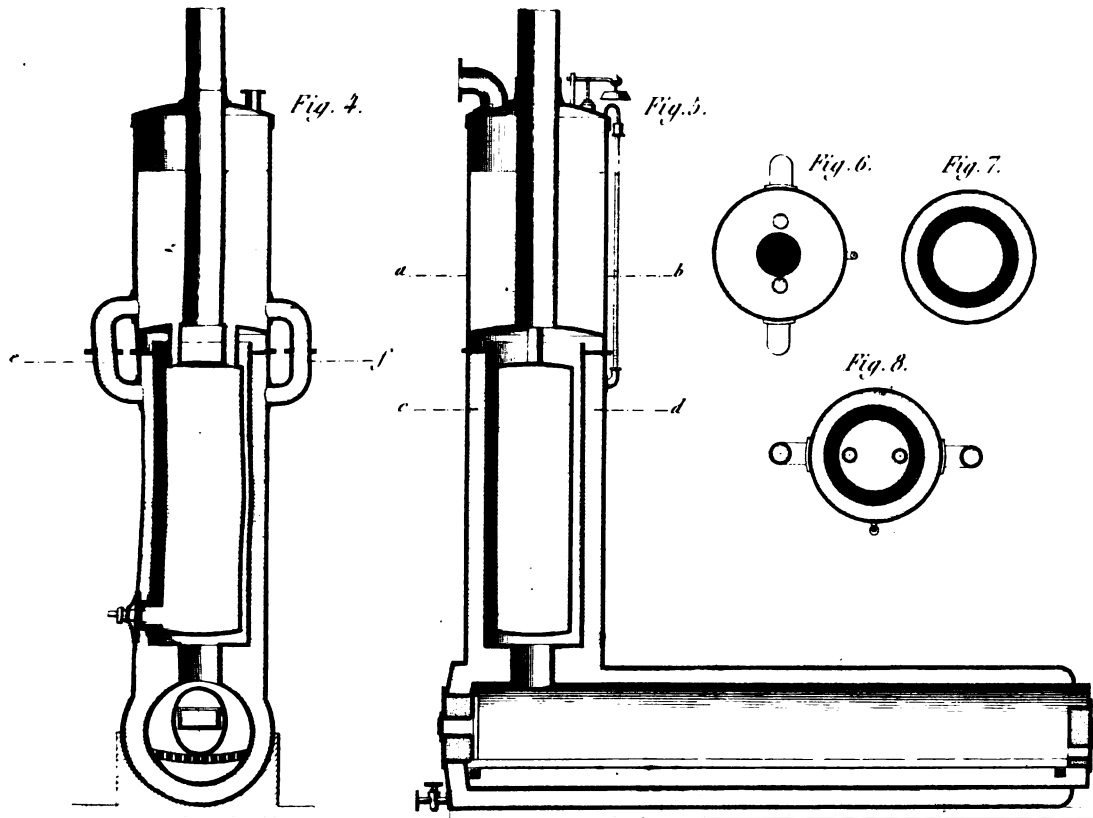
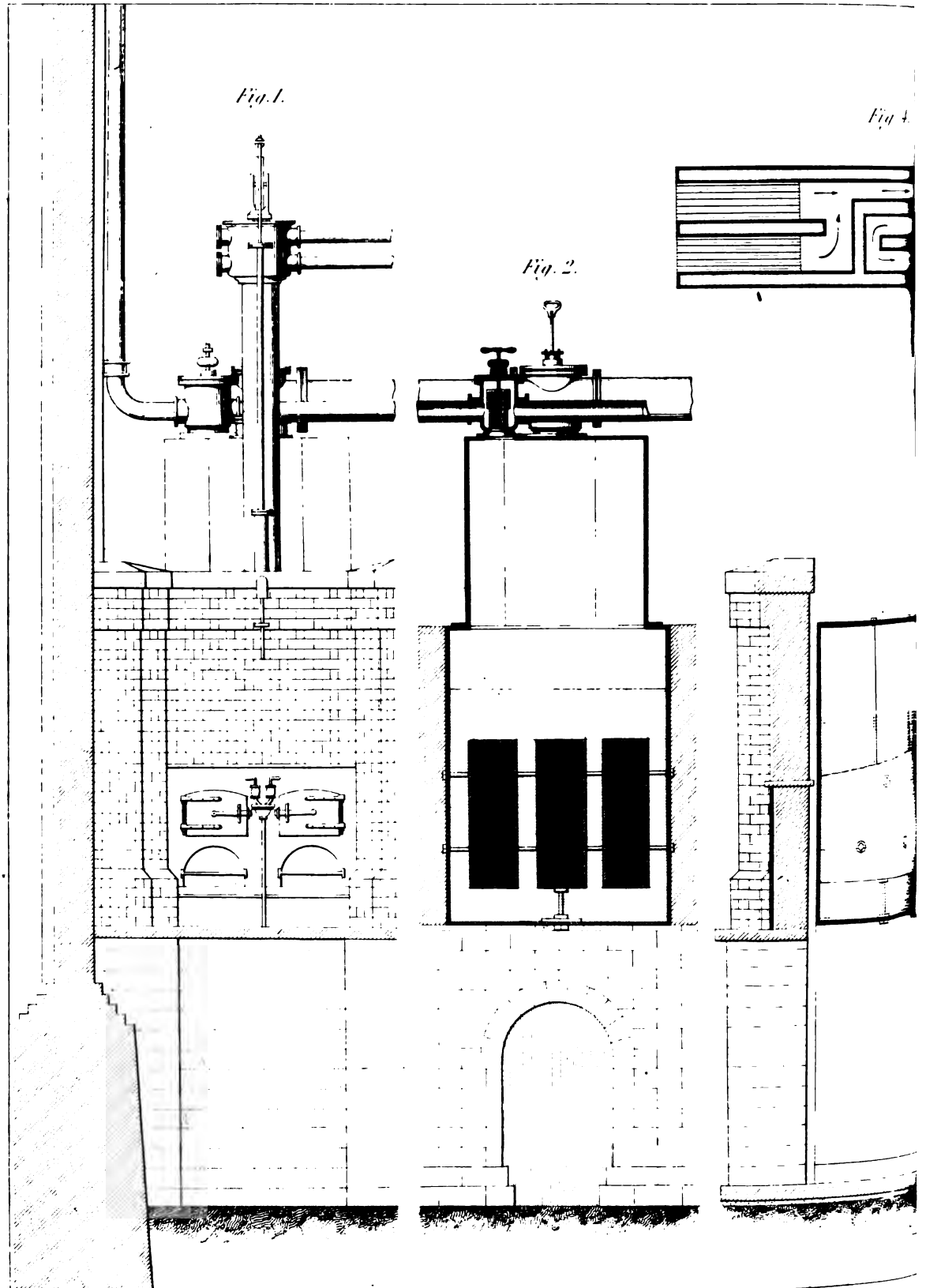


Fig. 10.







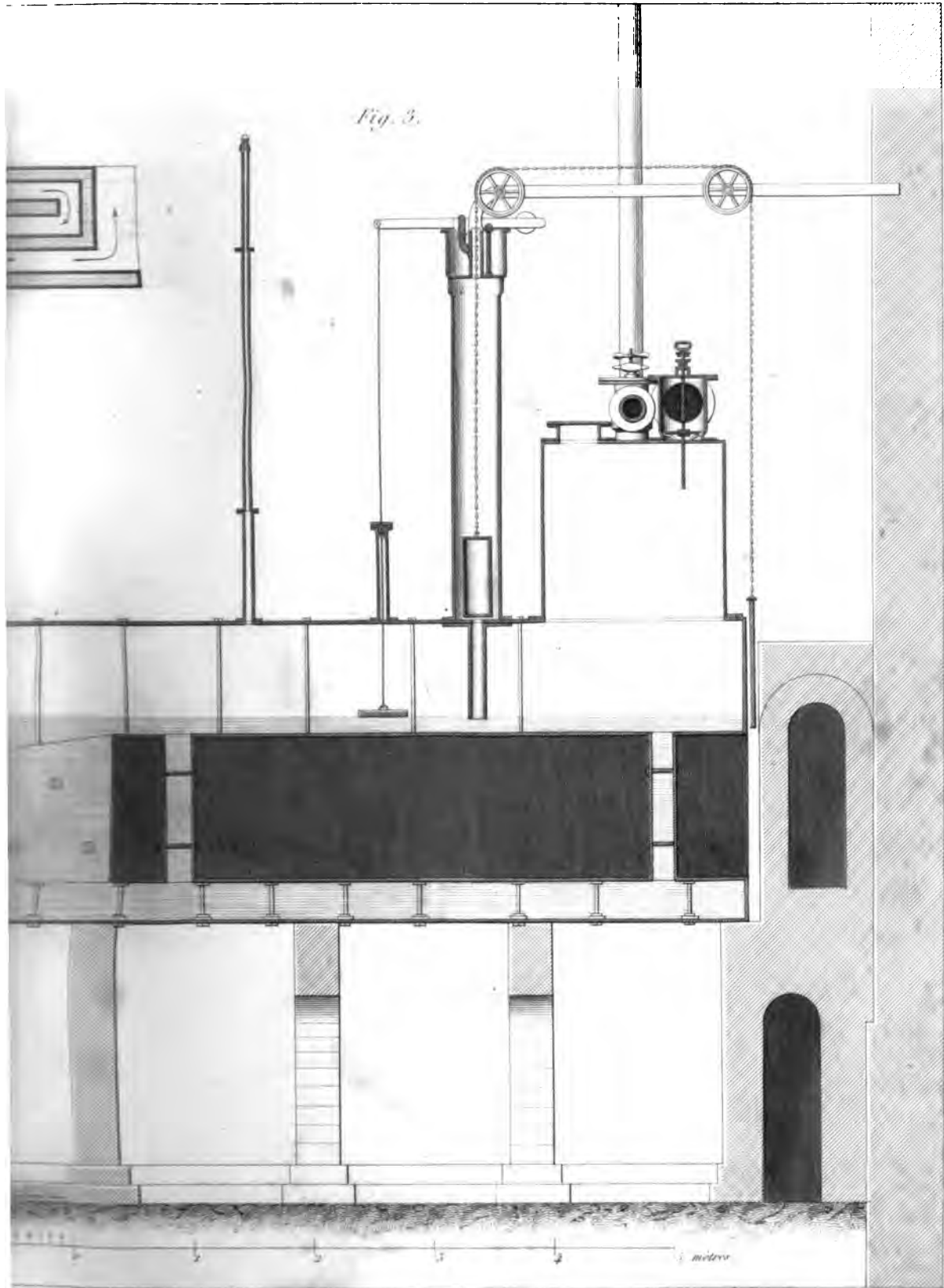


Fig. 3.

meters

Inveni per Duran



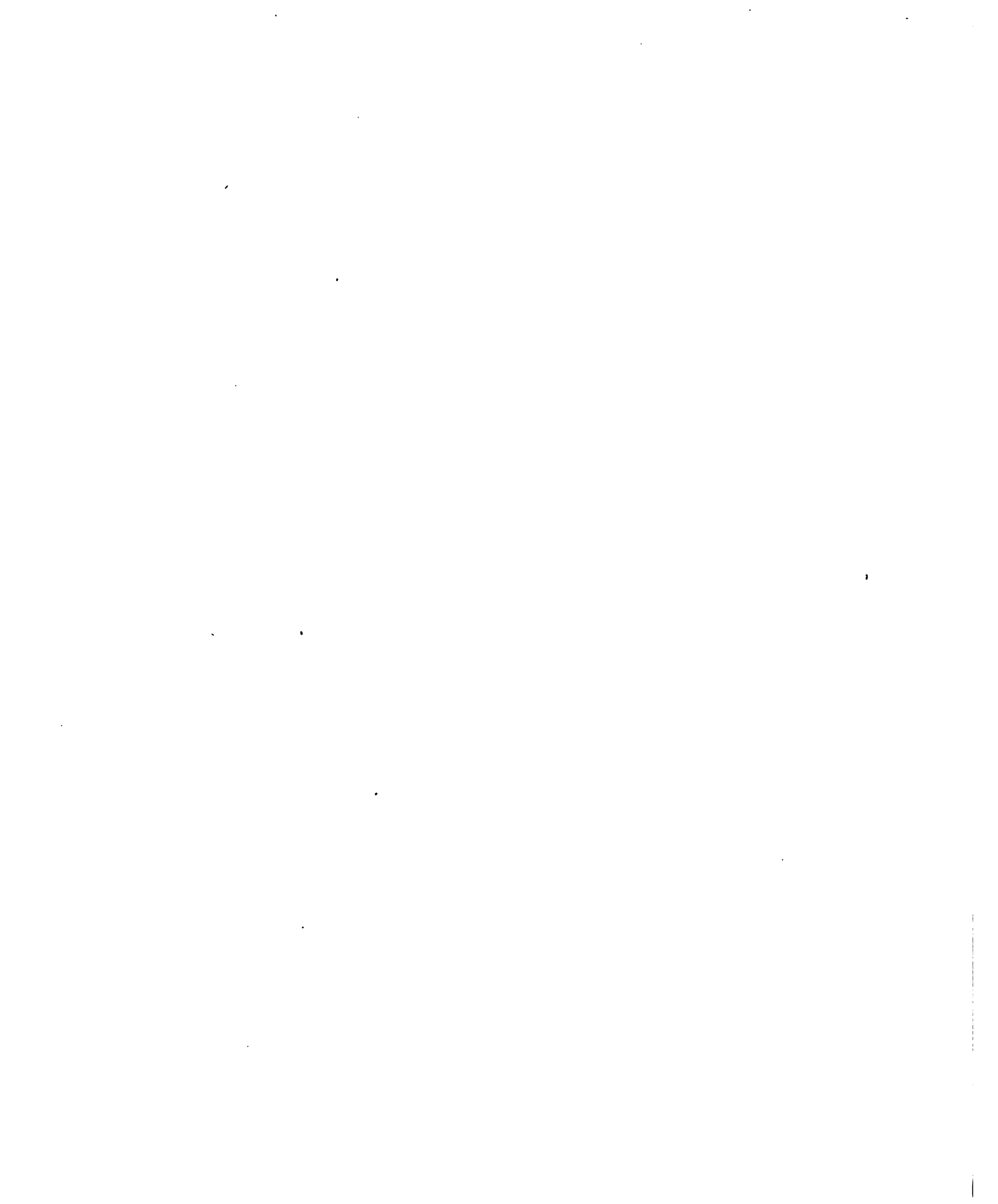


Fig. 1.

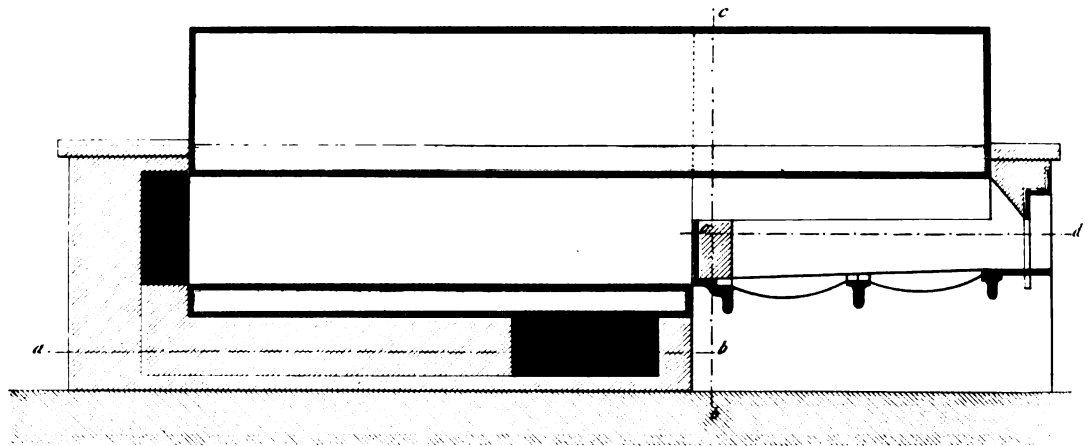


Fig. 3.

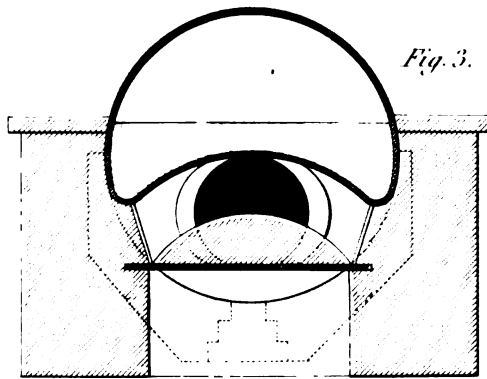


Fig. 4.

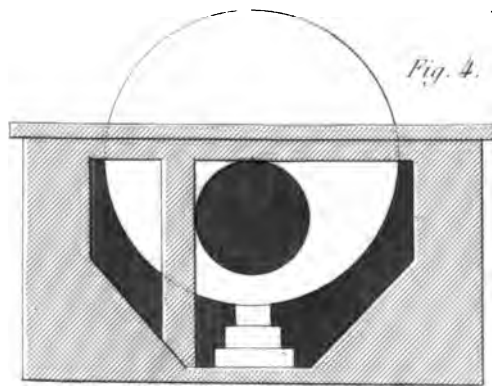


Fig. 5.

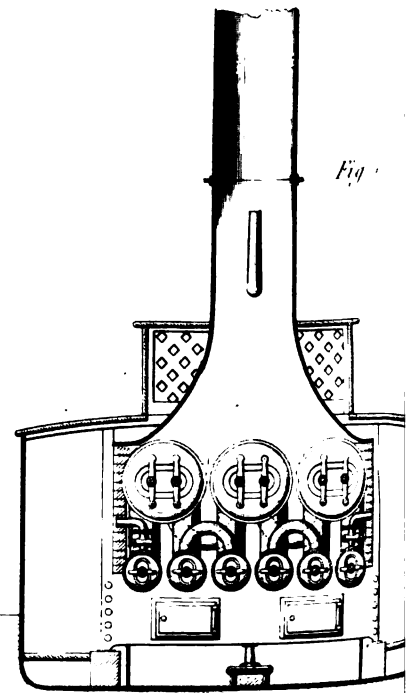
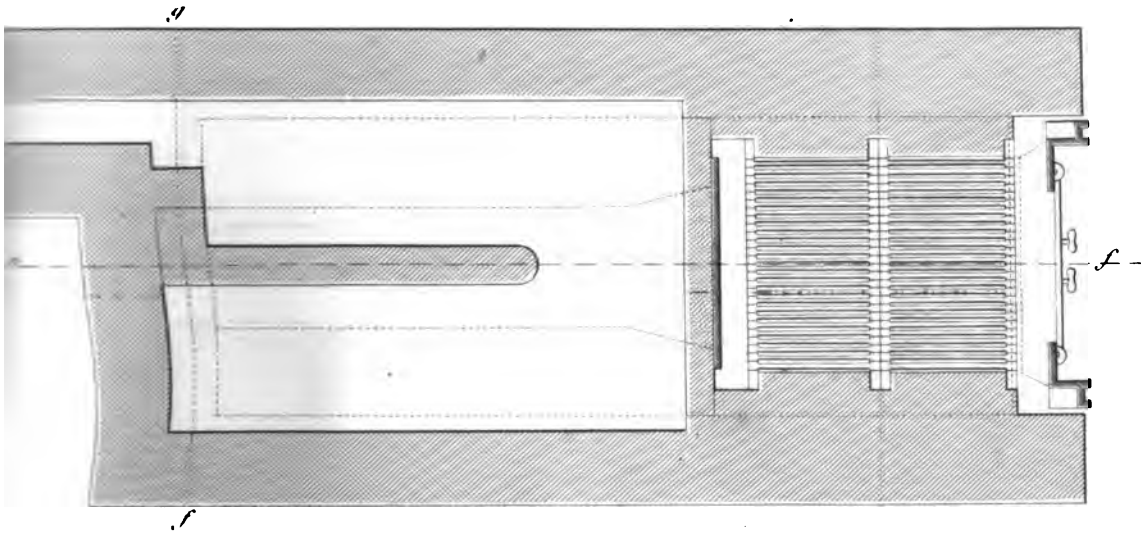


Fig. 2.



Echelle des Fig. 1, 2, 3 et 4.

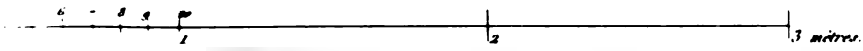
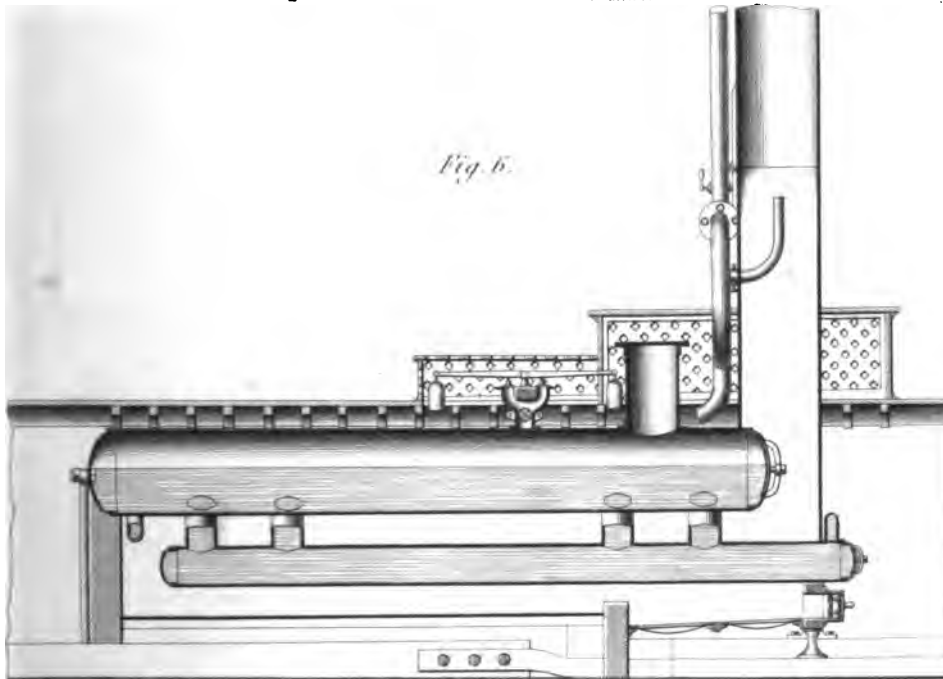
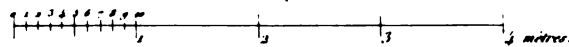
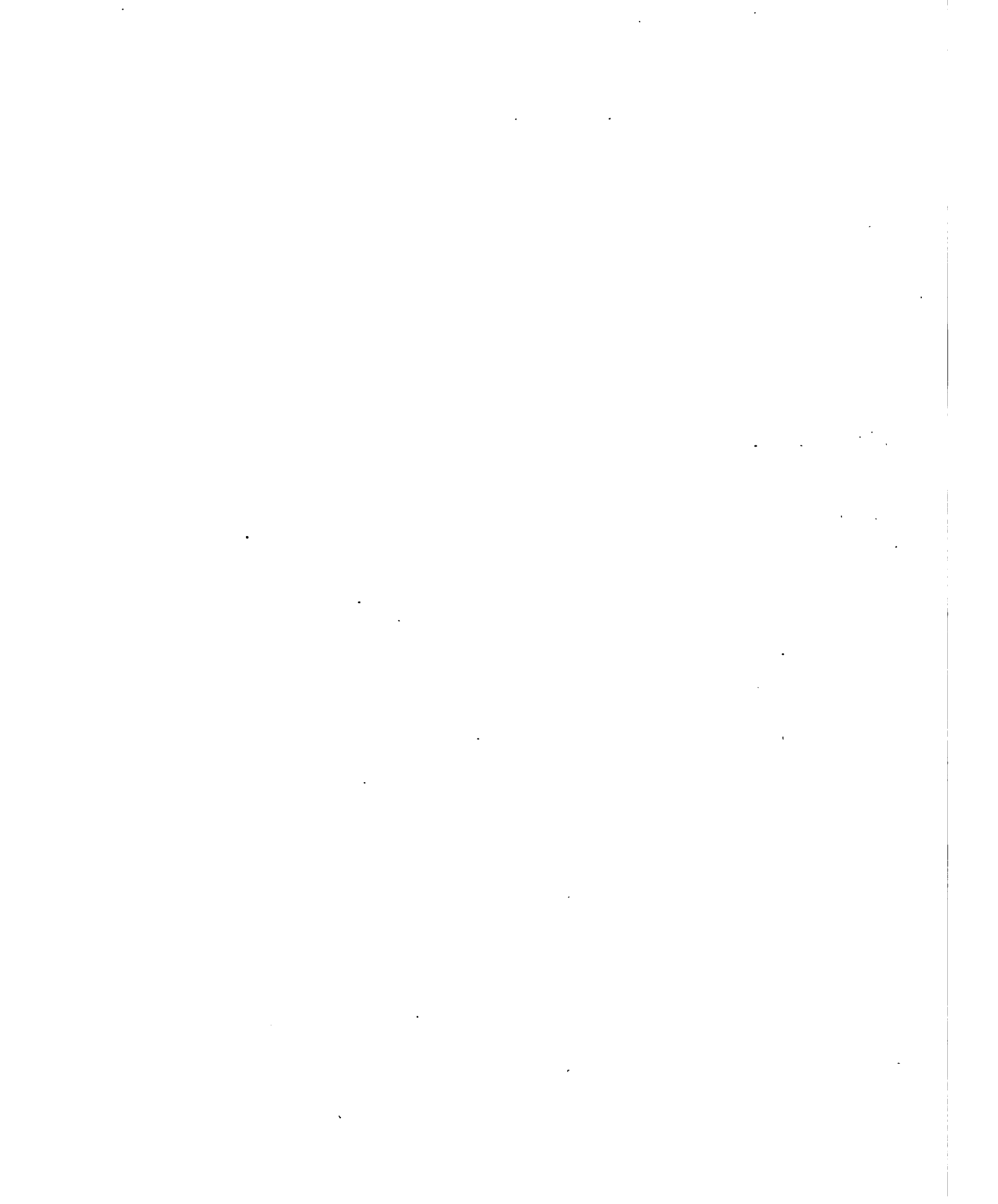


Fig. 6.



Echelle des Fig. 5 et 6.







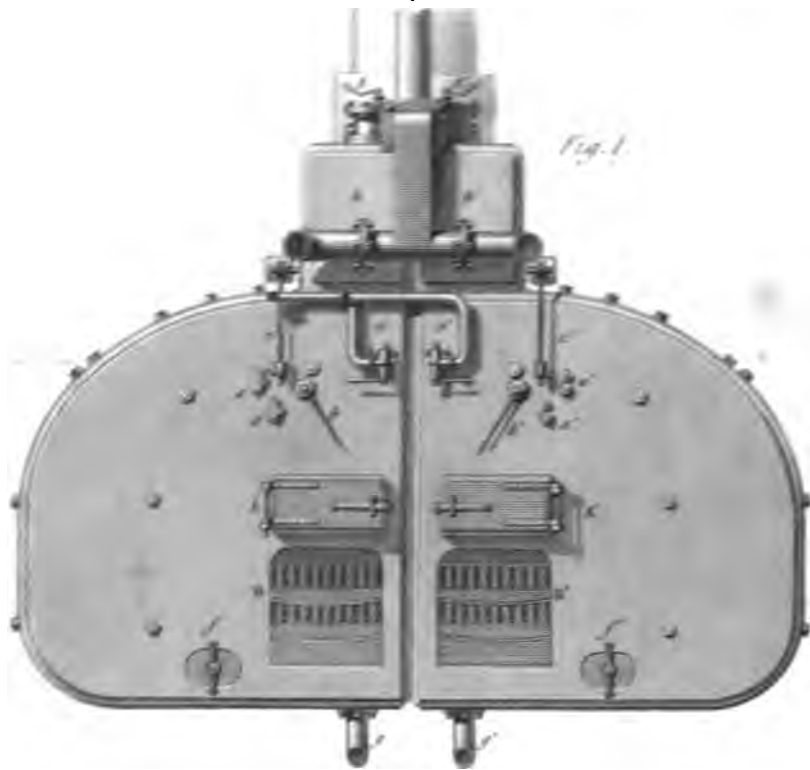


Fig. 1.

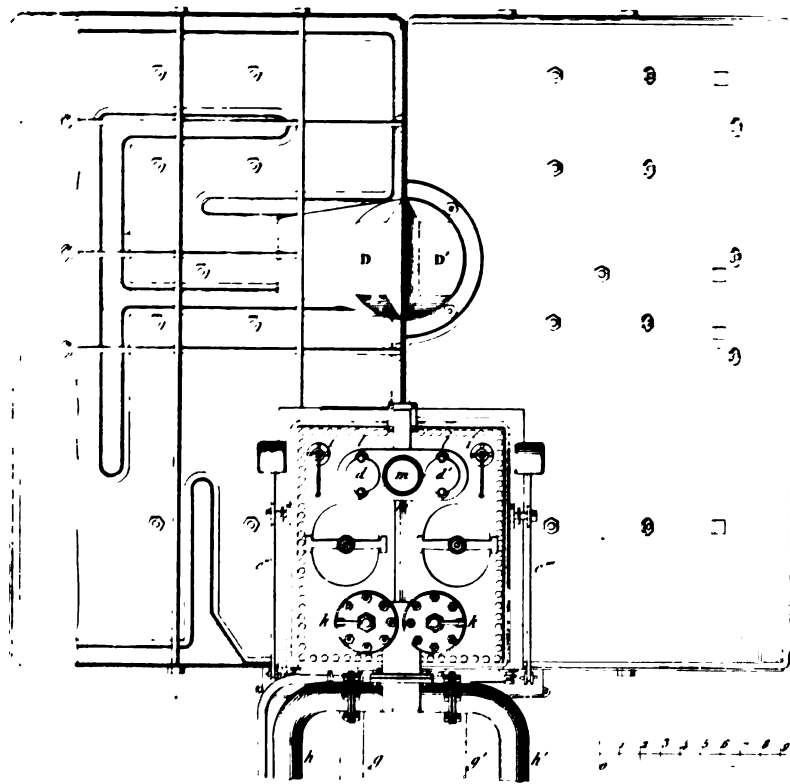
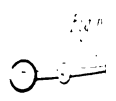
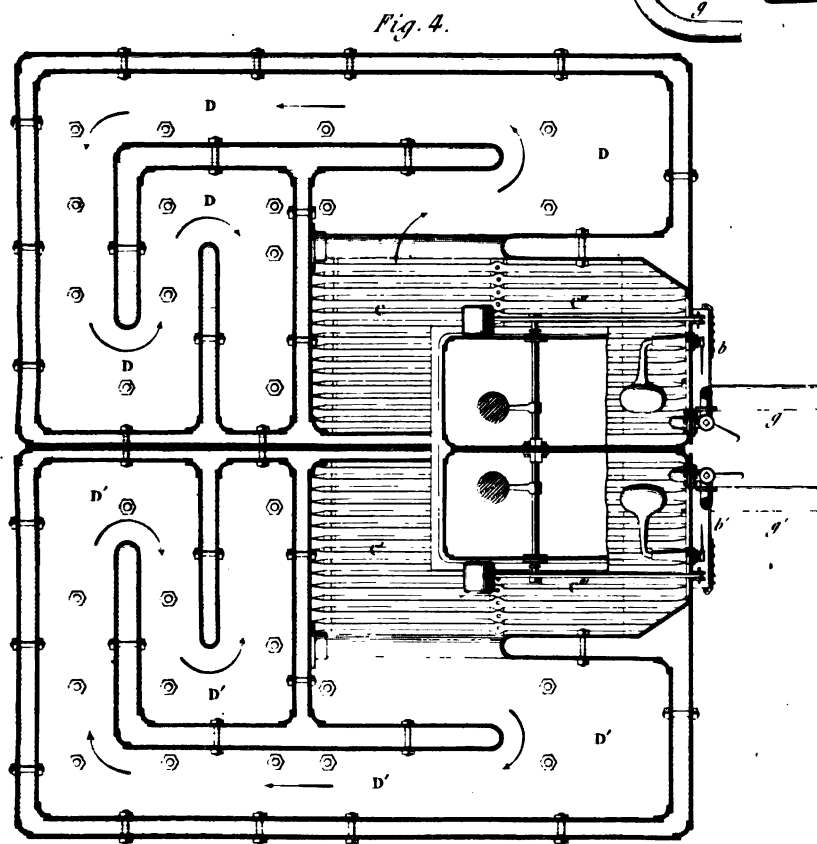
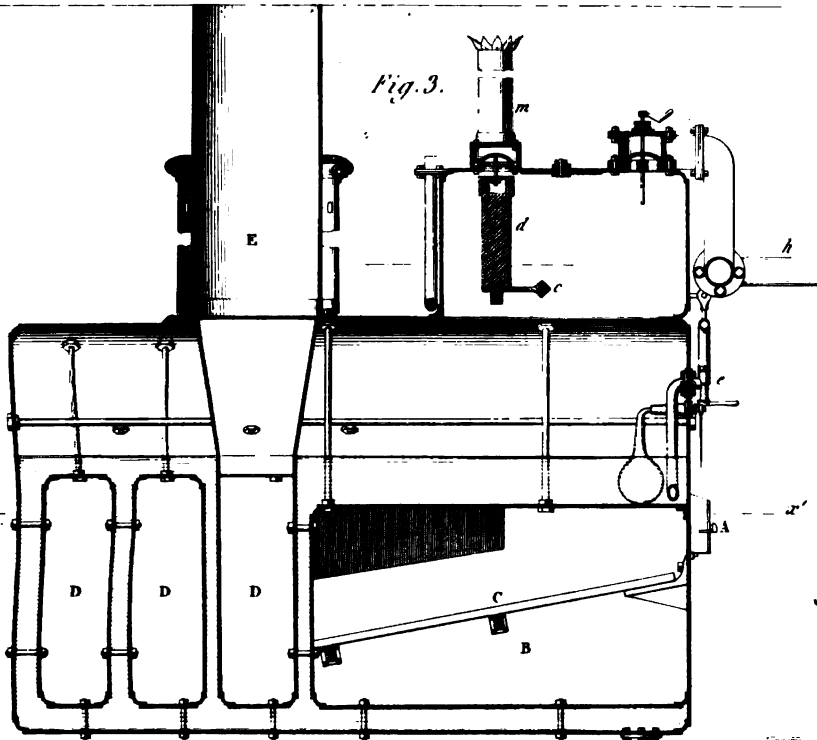


Fig. 2.



Echelle des Fig. 1, 2, 3 et 4

1 2 3 4 5 6 7 8 9 10 centim.



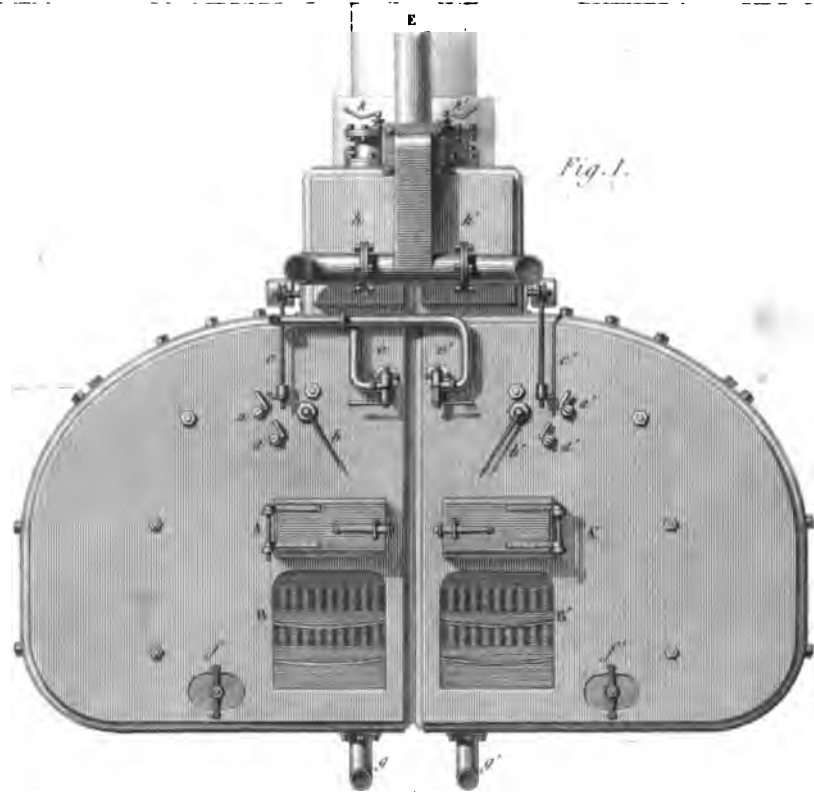


Fig. 1.

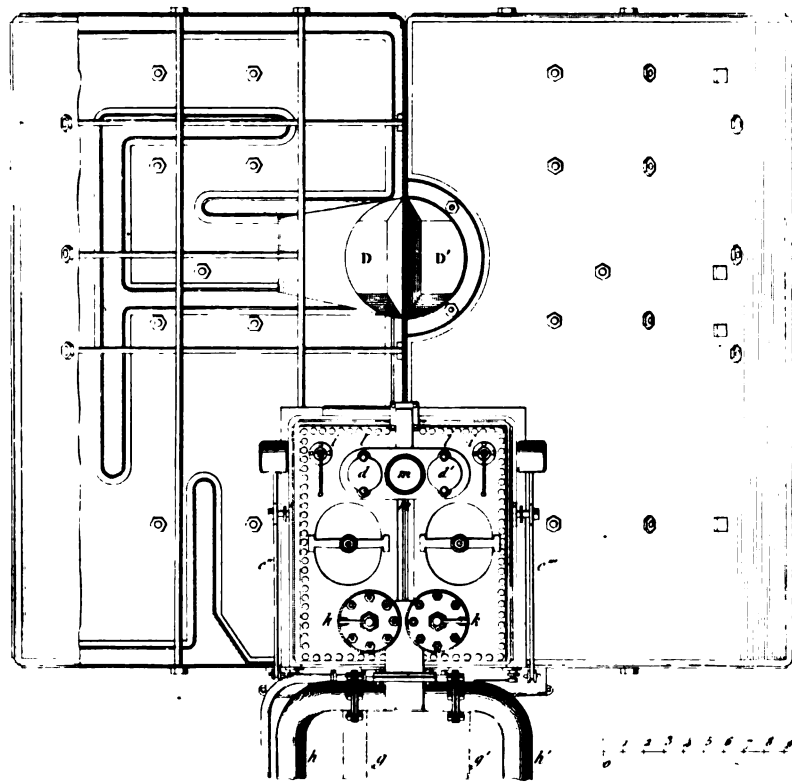


Fig. 2.

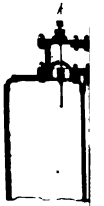


Fig.



Fig.

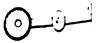
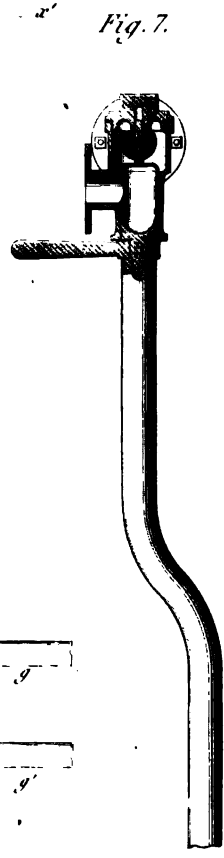
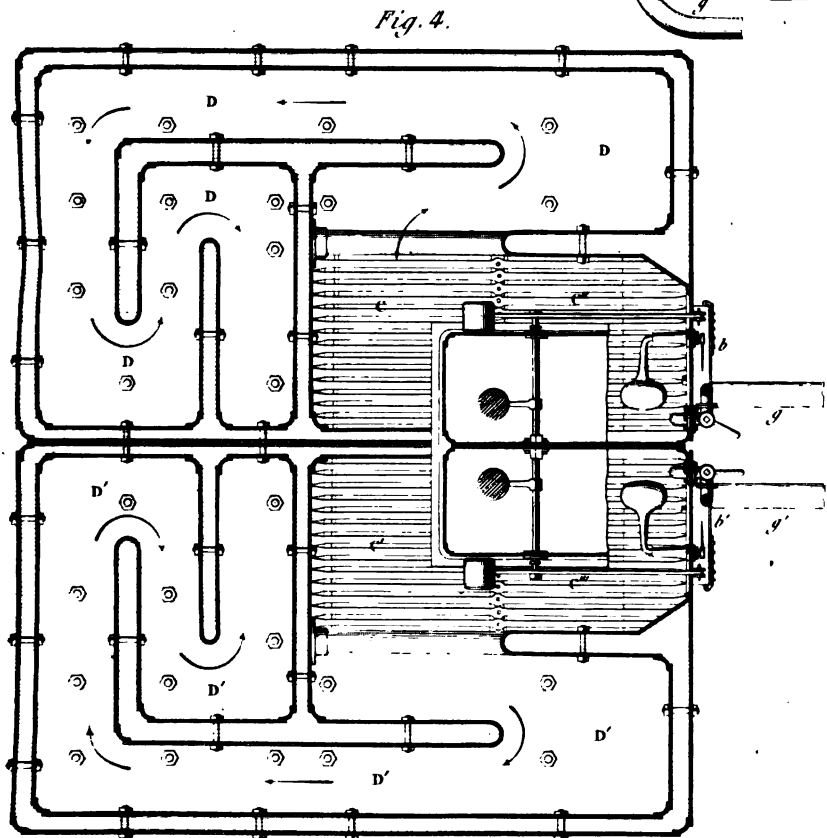
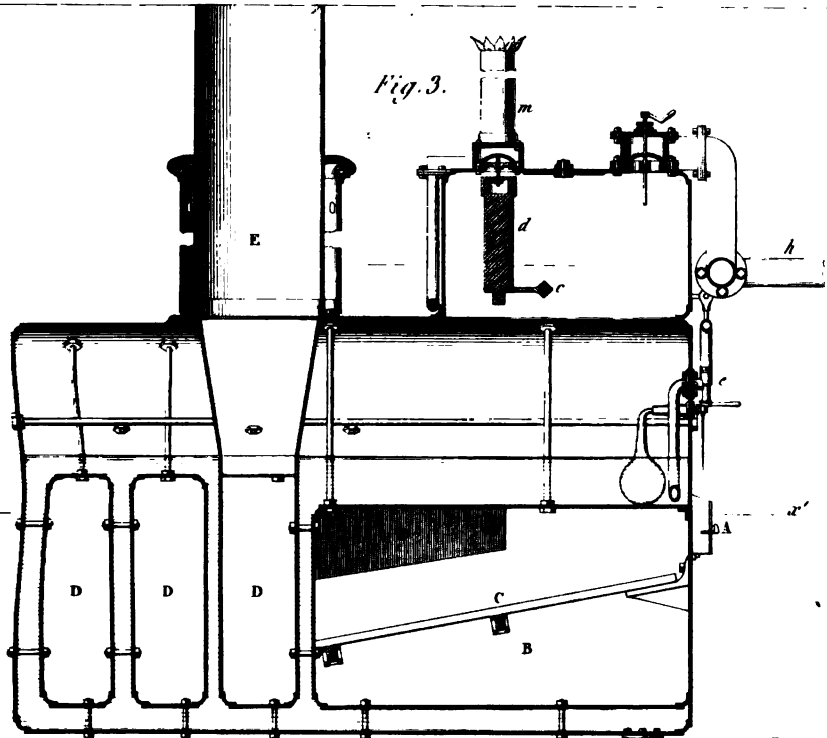


Fig.

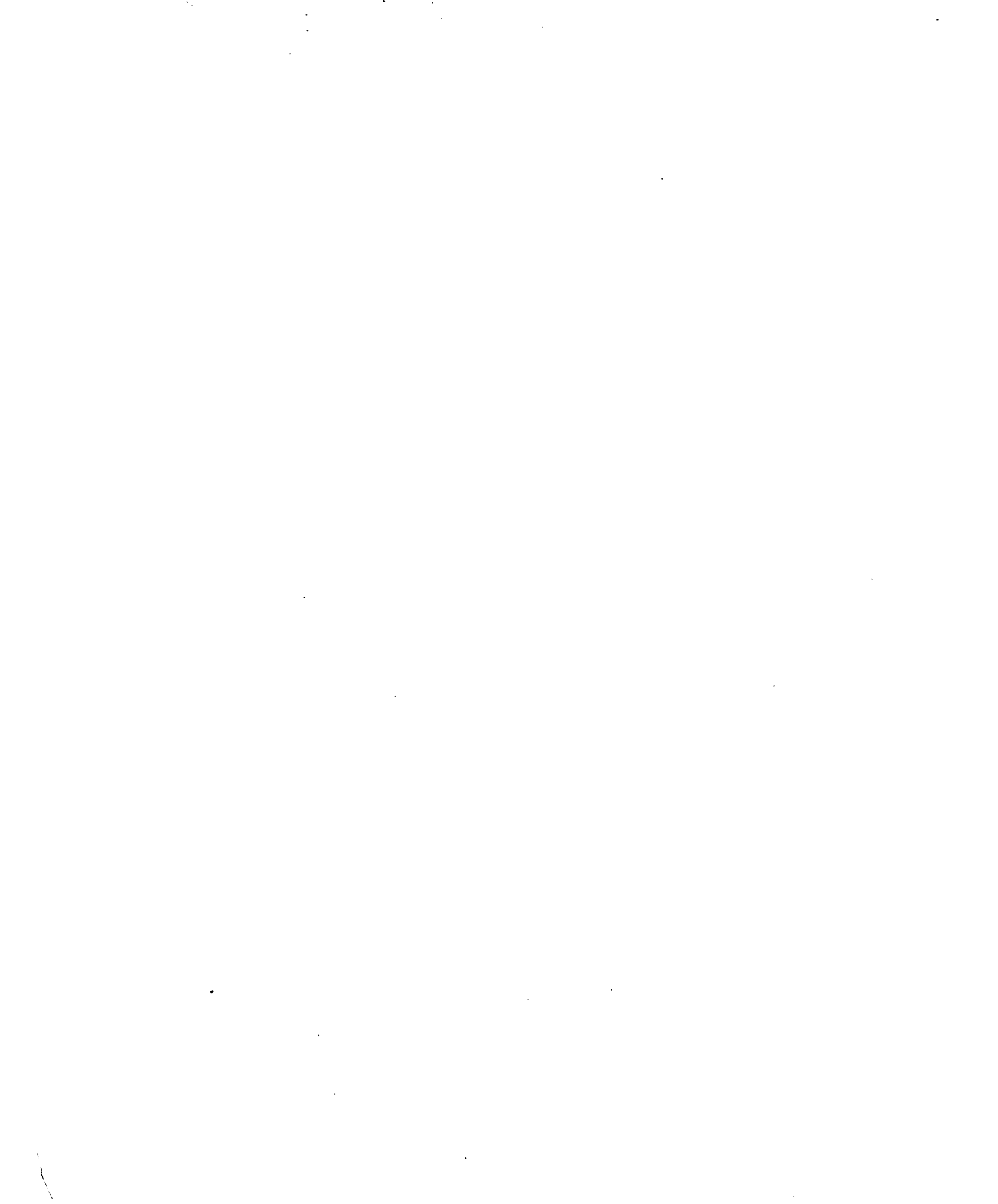


Echelle des Figs. 1, 2, 3 et 4

0 1 2 3 4 5 6 7 8 9 10 centim.







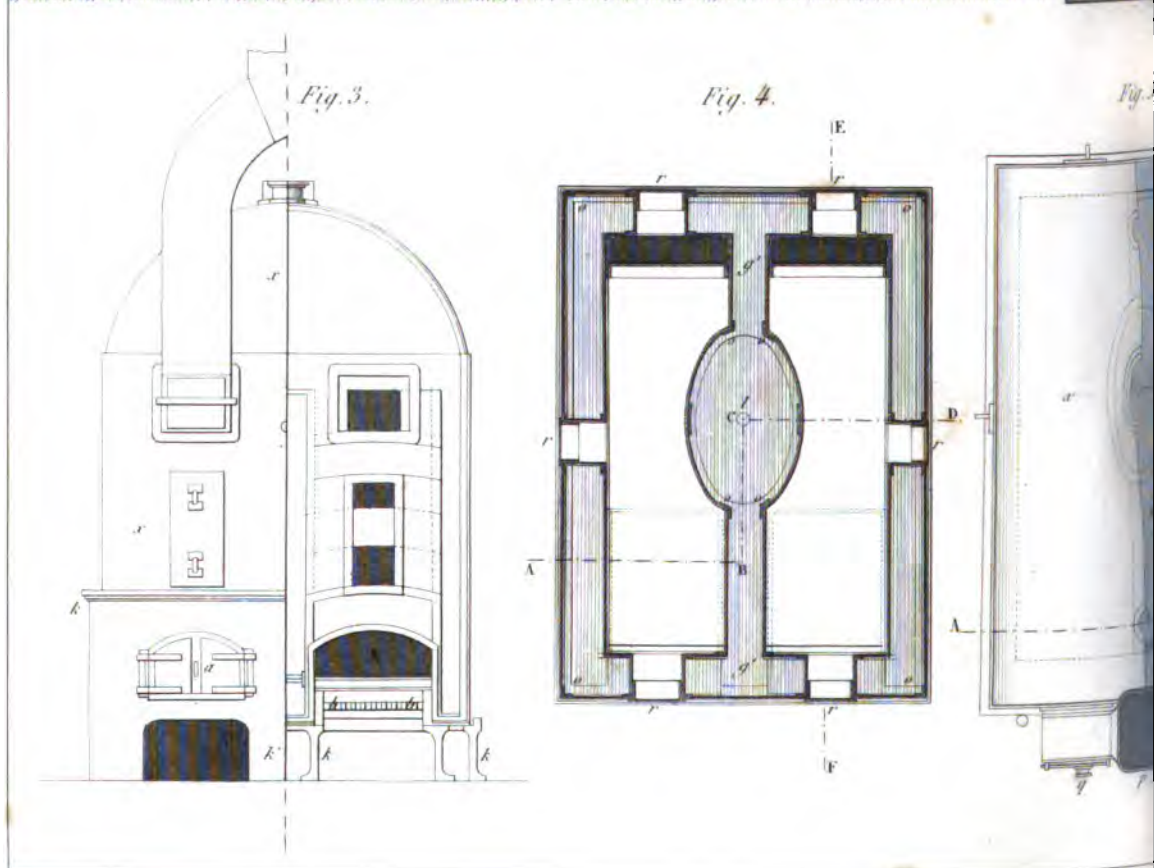
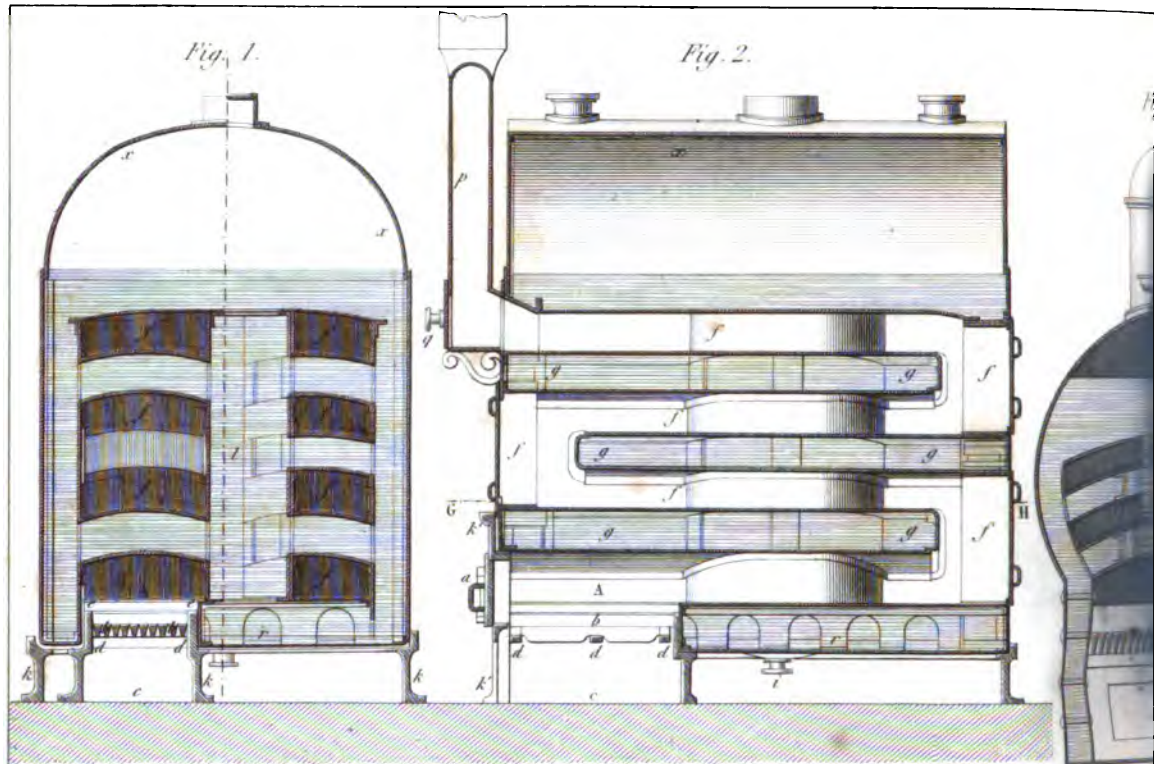


Fig. 7.

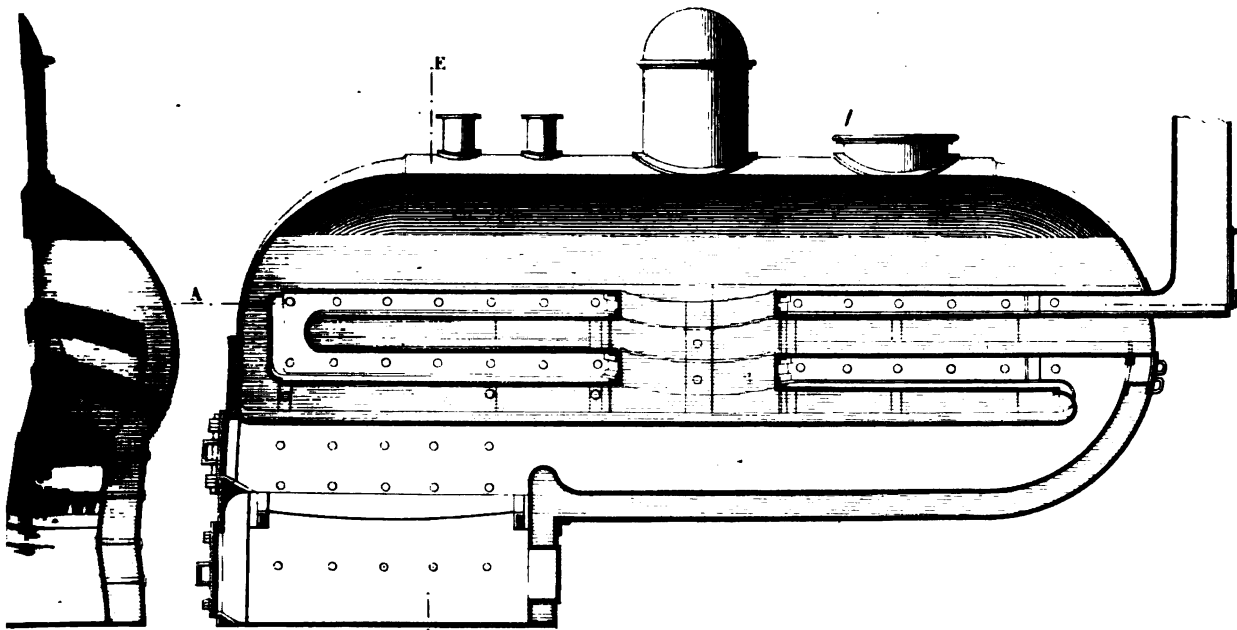
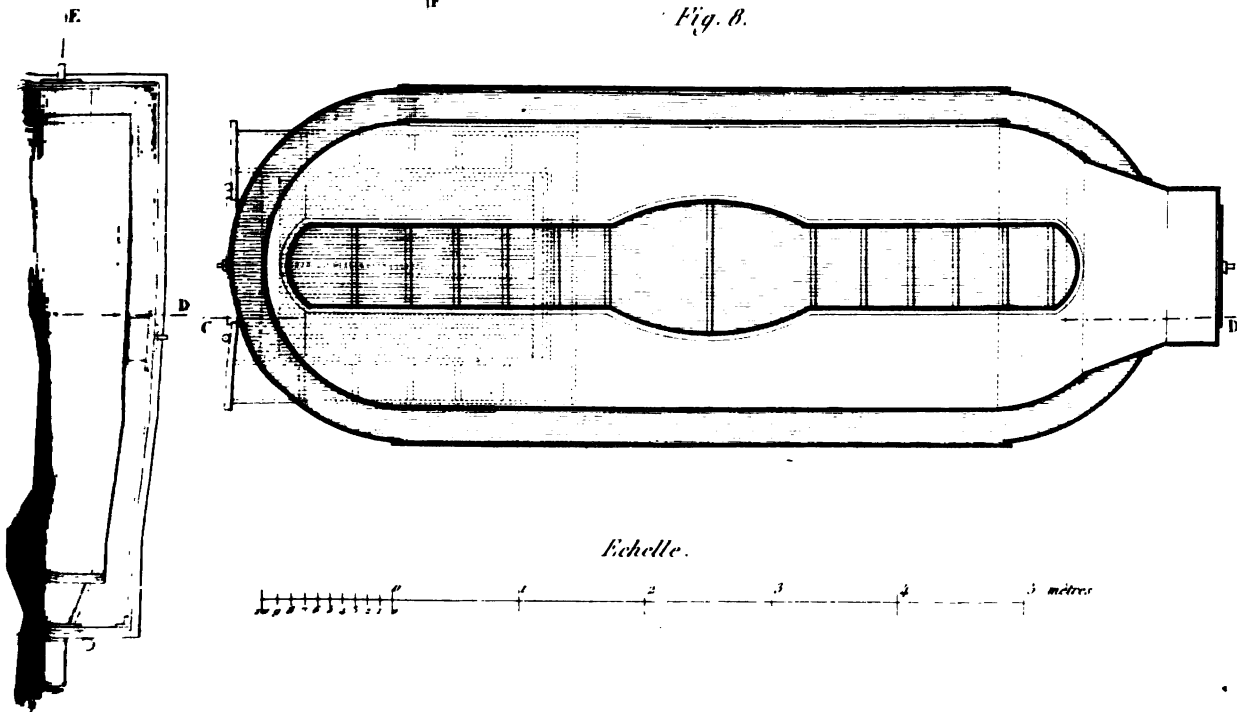
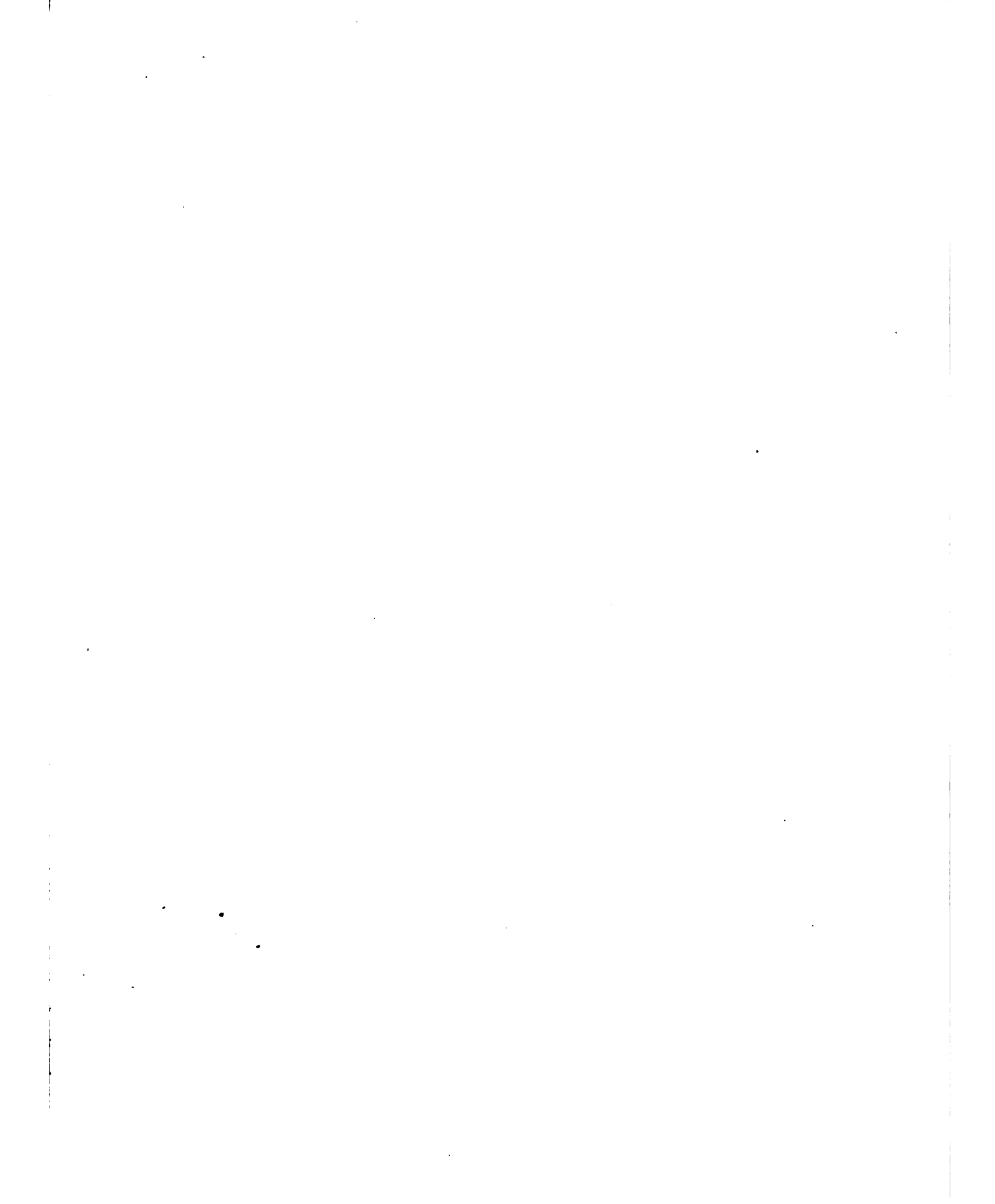
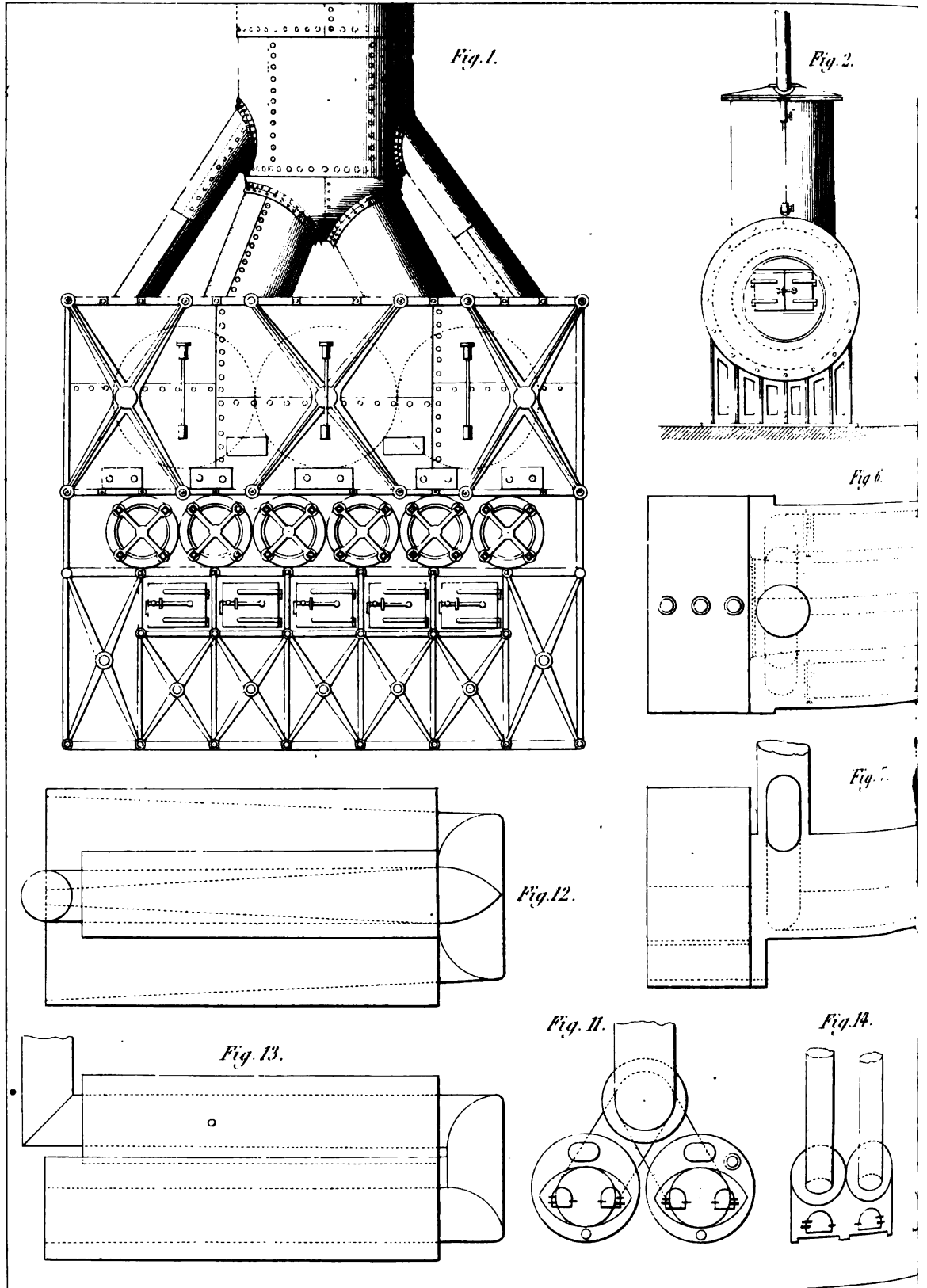


Fig. 8.









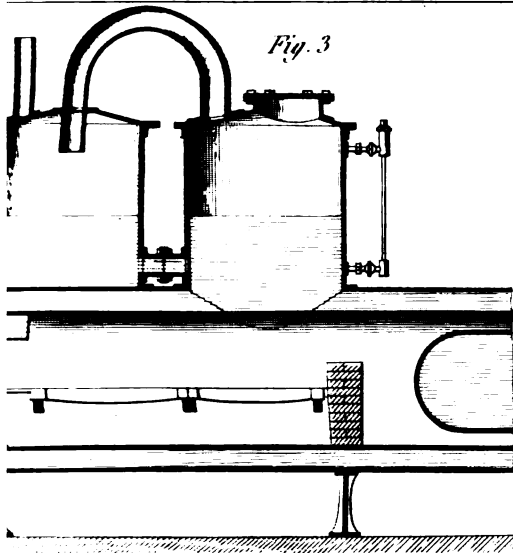


Fig. 3.

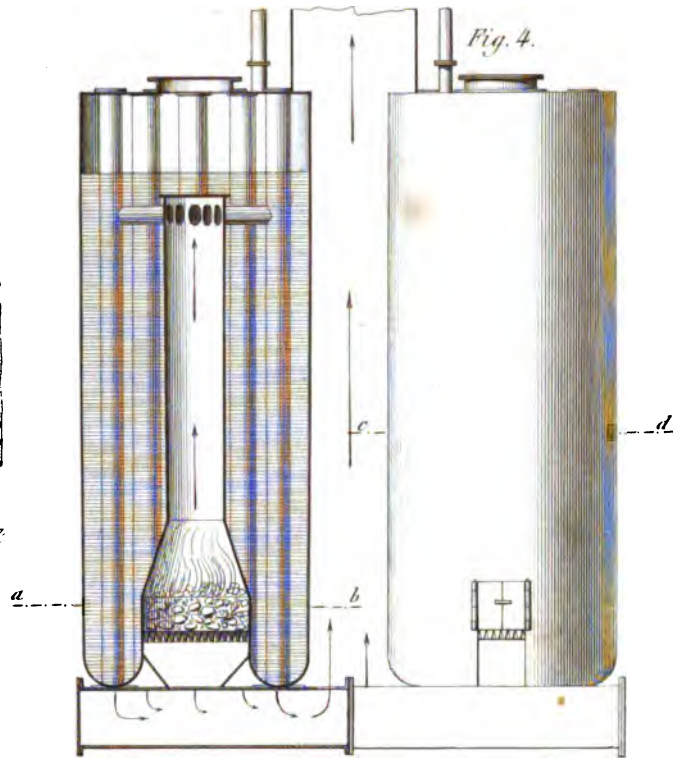


Fig. 4.

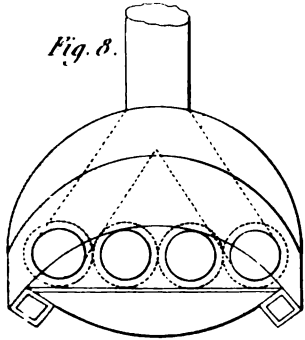
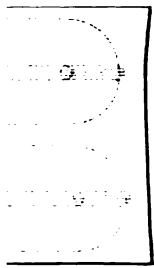


Fig. 8.

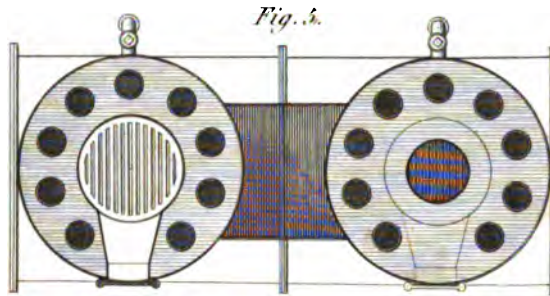


Fig. 5.

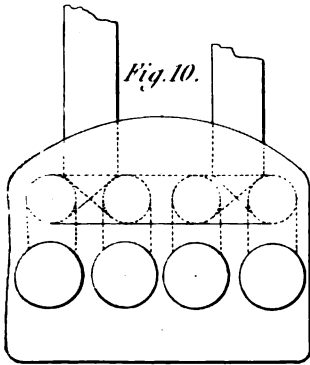
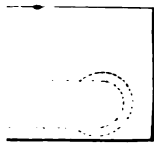


Fig. 10.

Echelle des Fig. 4 et 5.

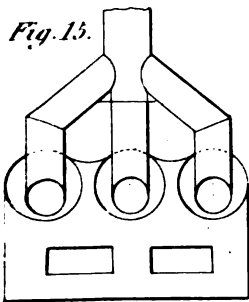
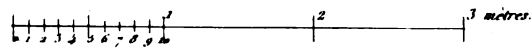


Fig. 15.

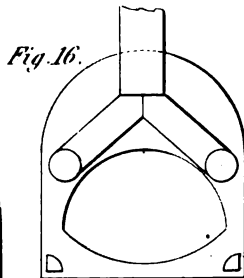


Fig. 16.

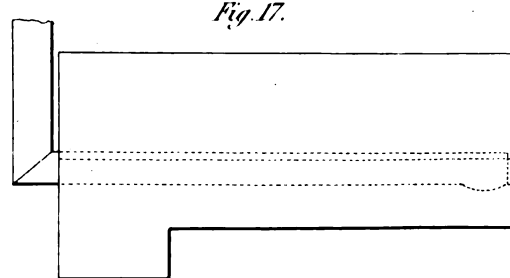
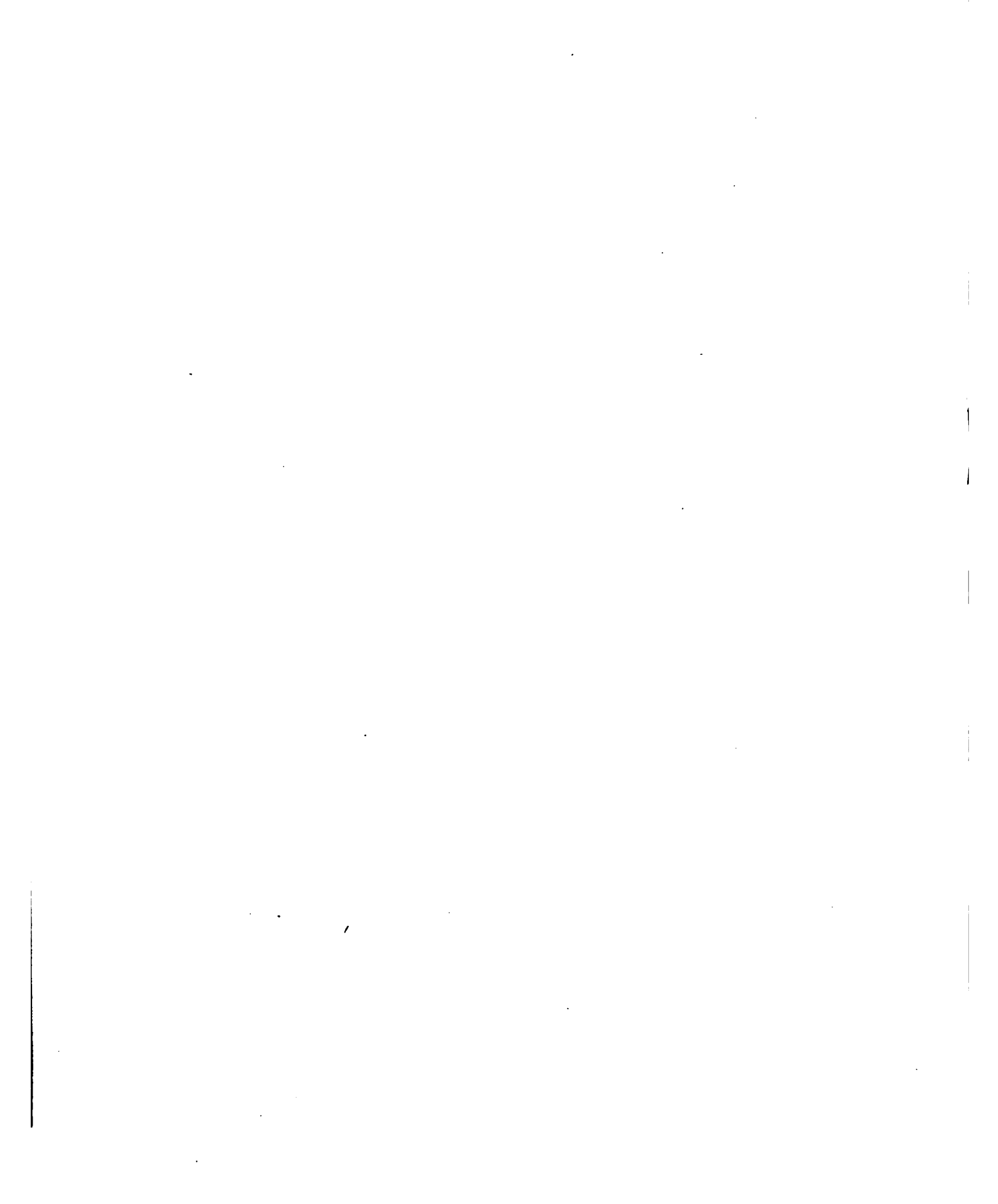
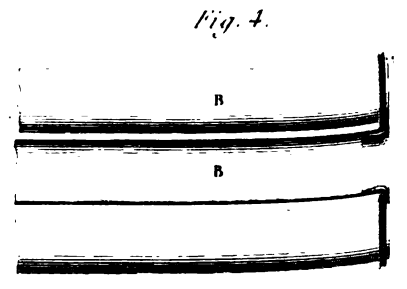
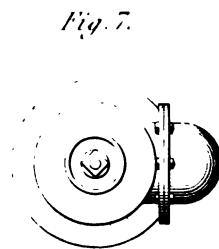
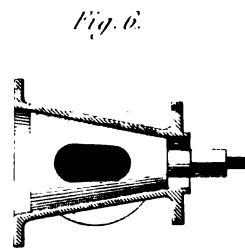
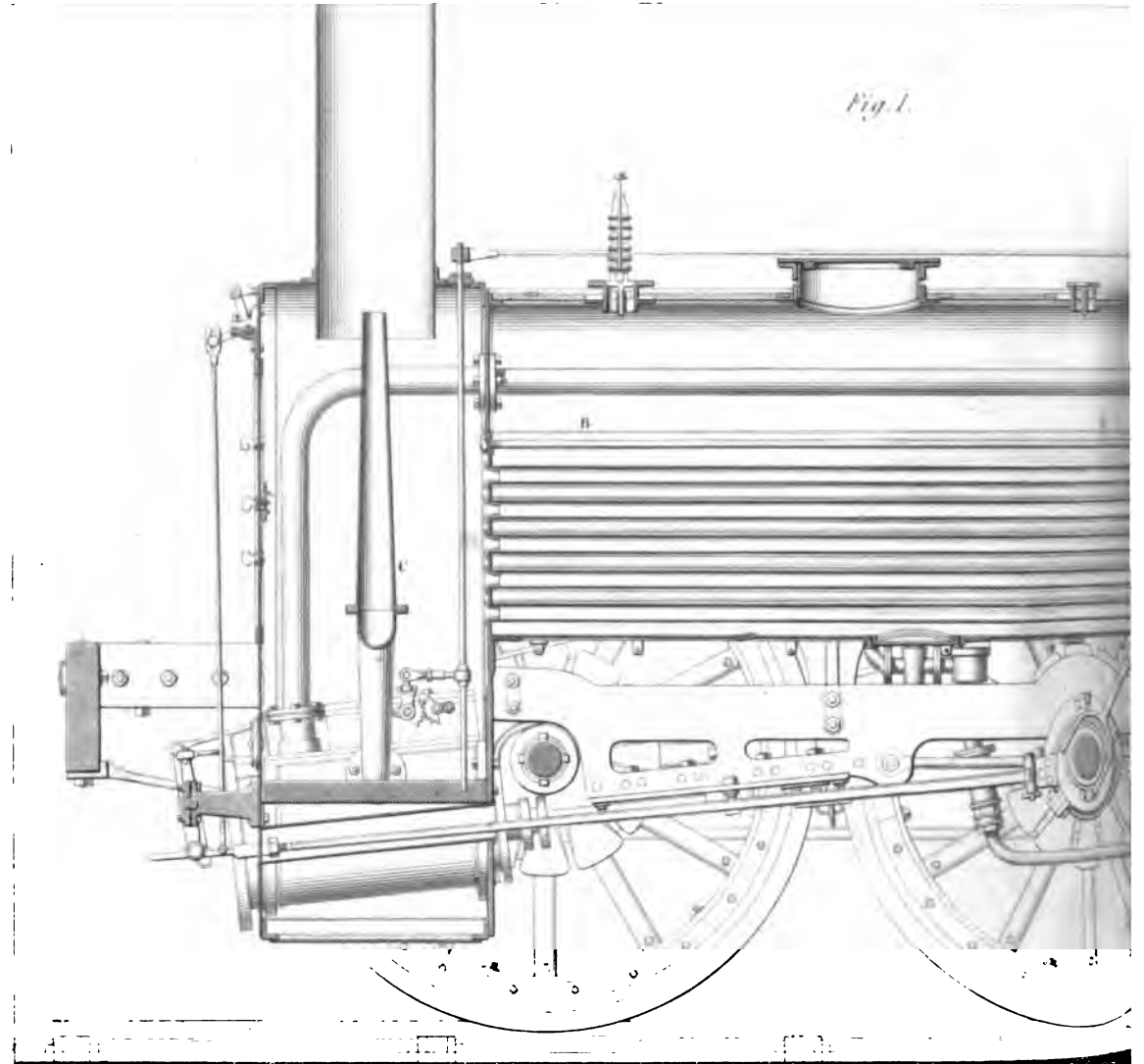


Fig. 17.







Echelle des Fig. 1, 2 et 3.
0 1 2 3 4 5 6 7 8 9 10 décimètres

2 mètres

Fig. 2.

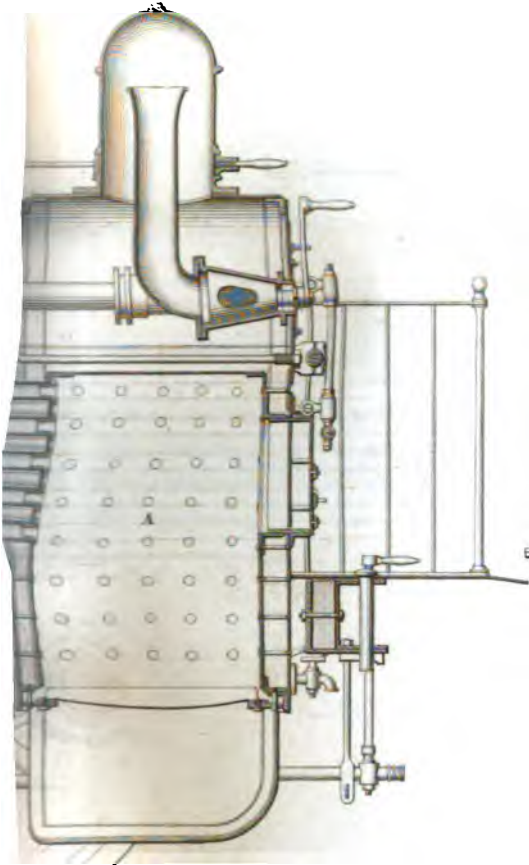
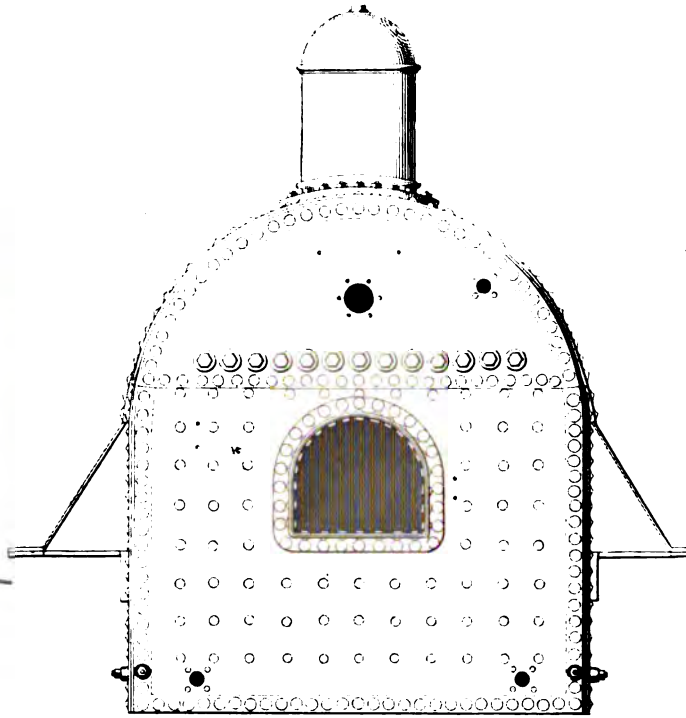


Fig. 3.

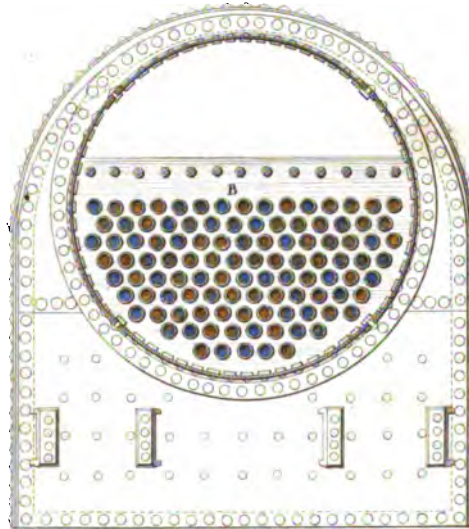
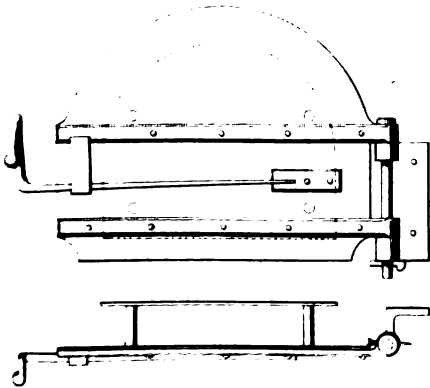


Fig. 5.



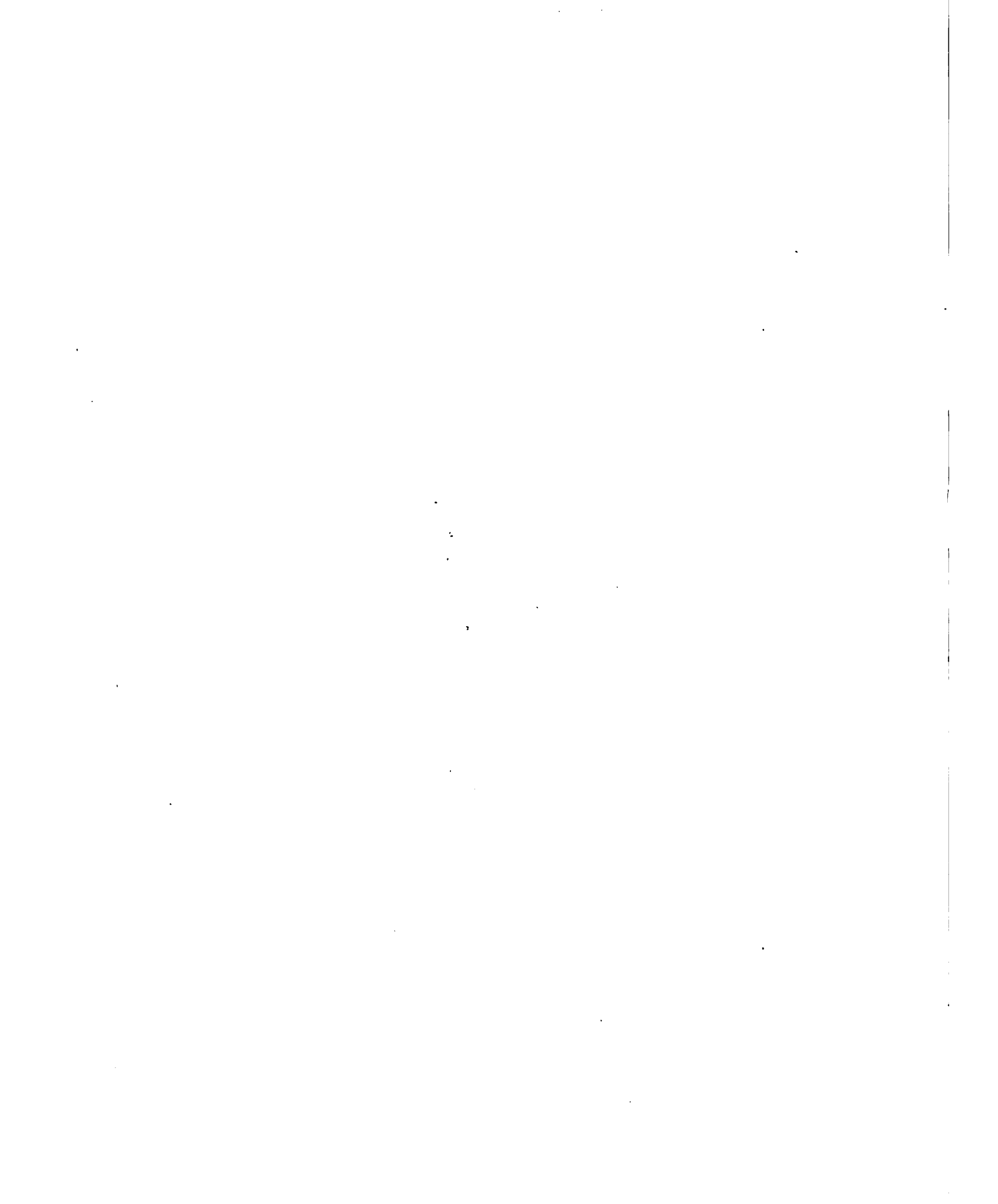




Fig. 4.



Fig. 2.

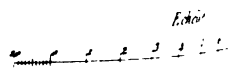
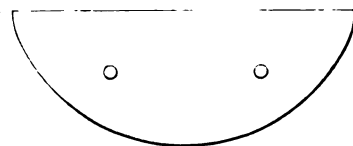
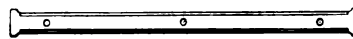
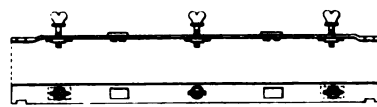
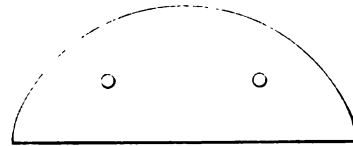
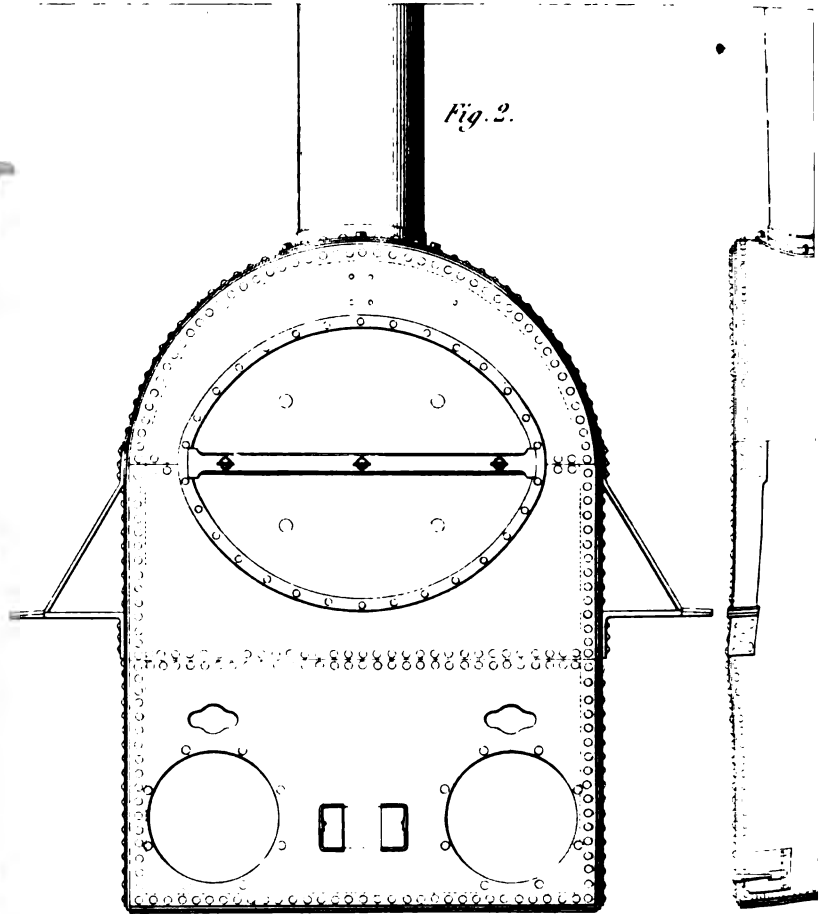


Fig. 7.

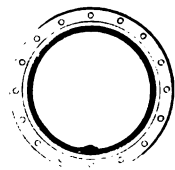


Fig. 1.

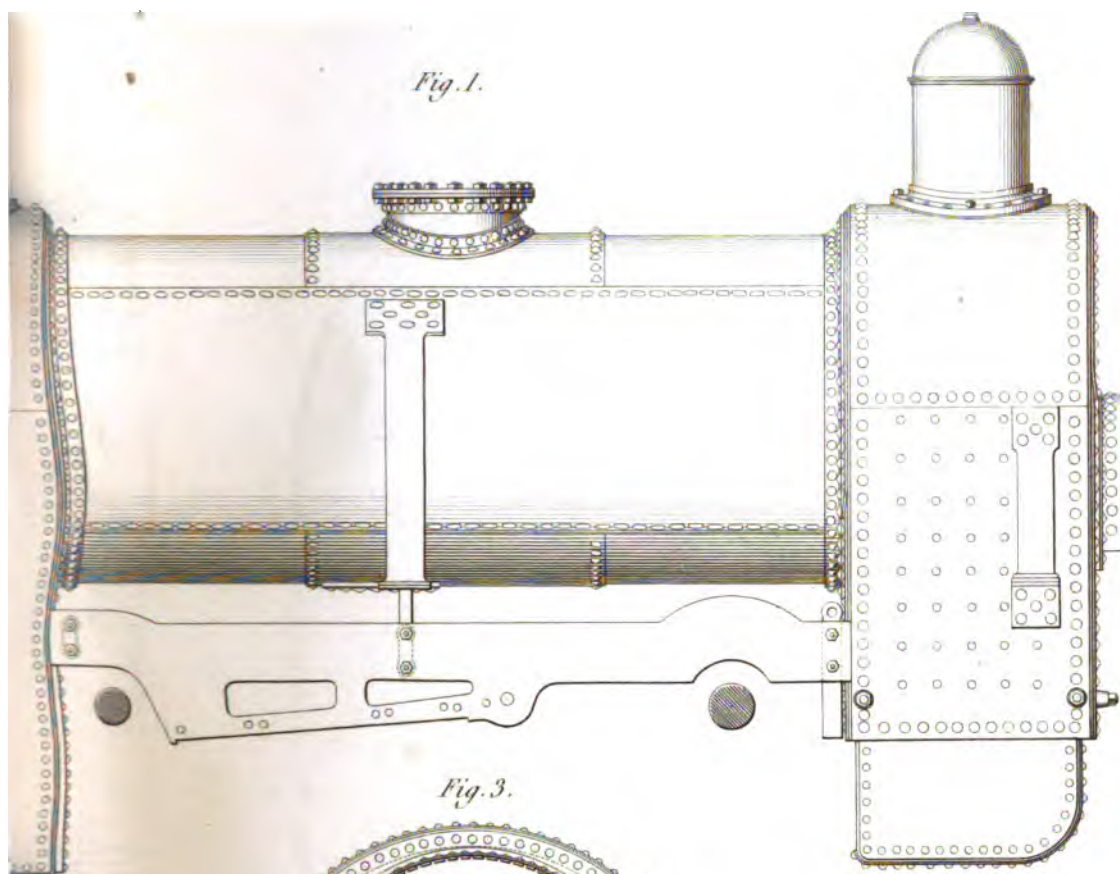


Fig. 3.

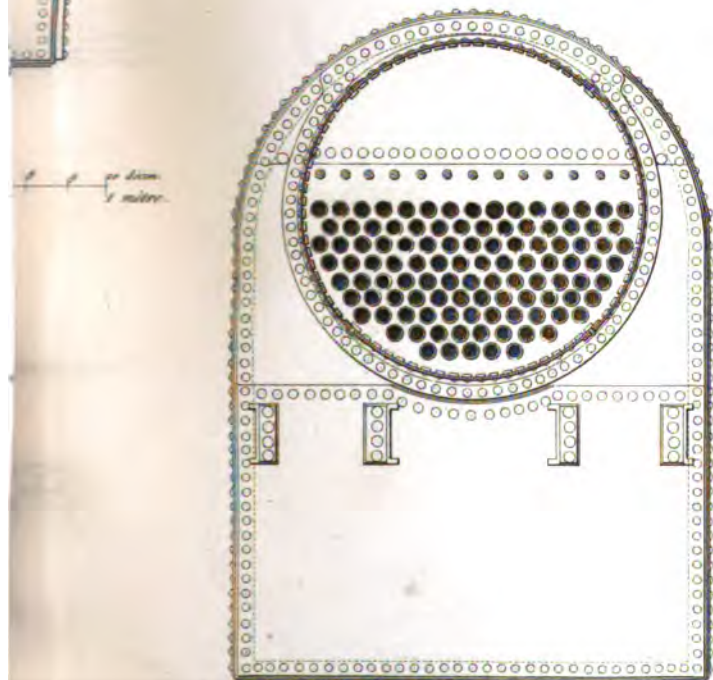


Fig. 5.

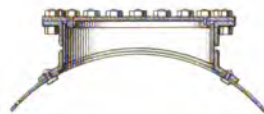


Fig. 6.





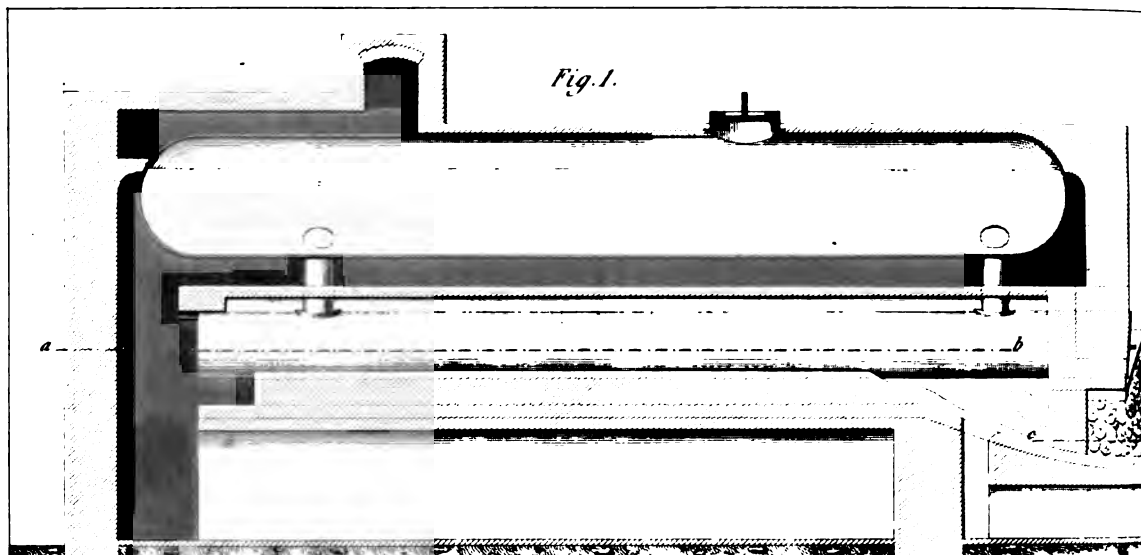


Fig. 1.

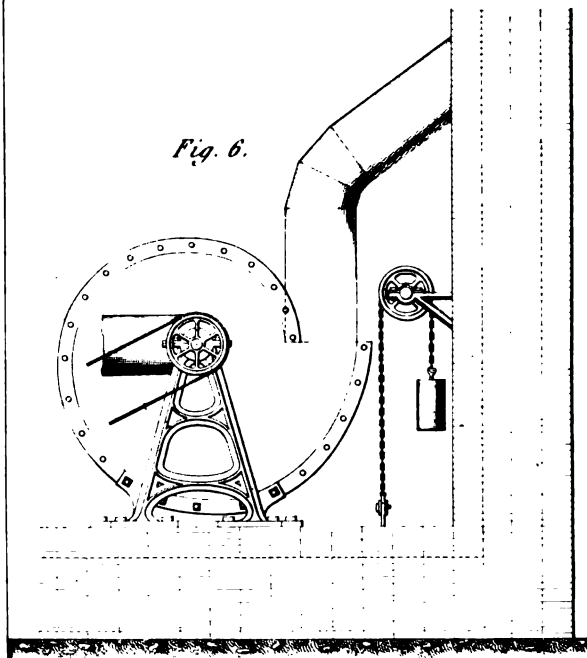
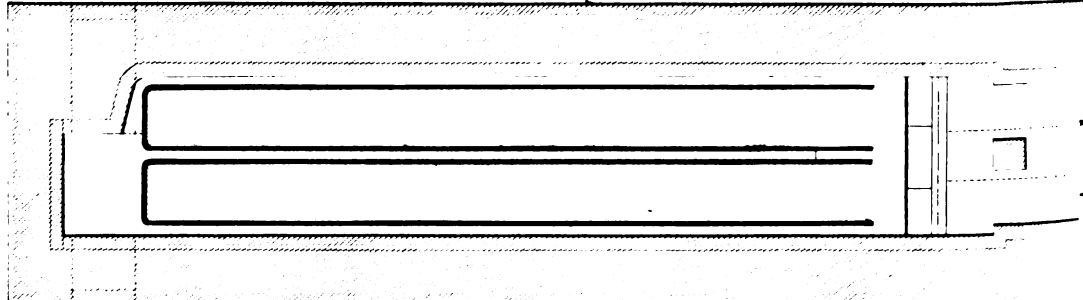
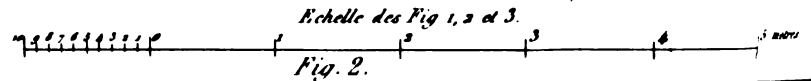


Fig. 6.

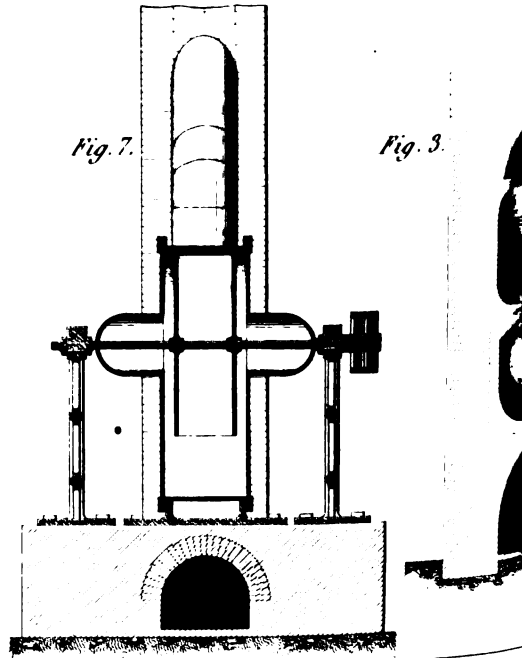


Fig. 7.

Fig. 3.

Fig. 4.

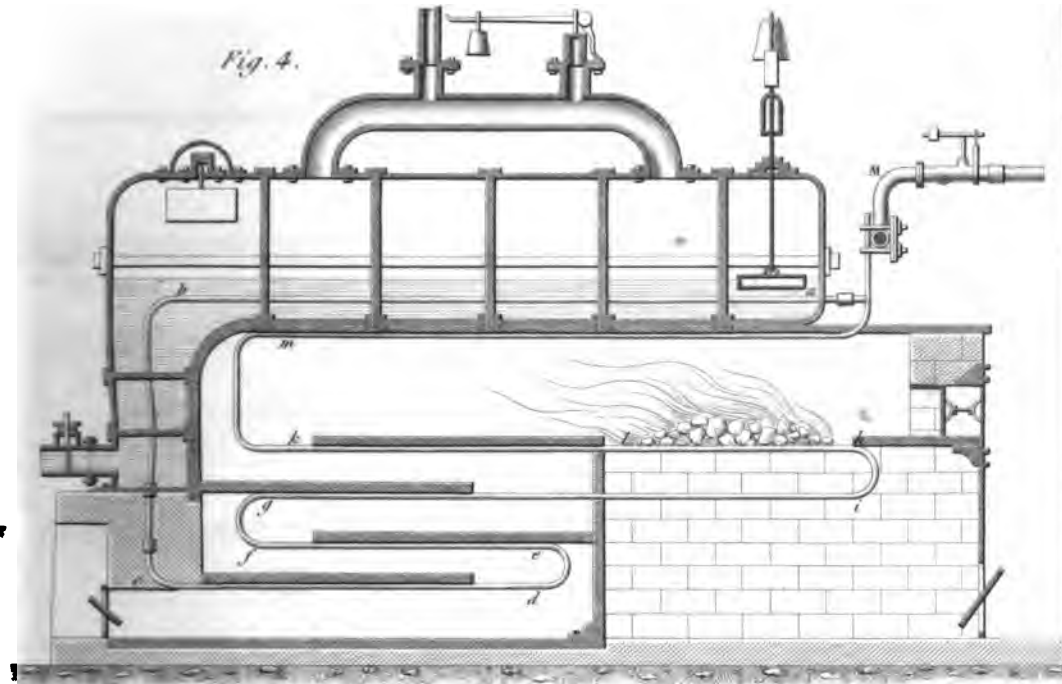


Fig. 5.

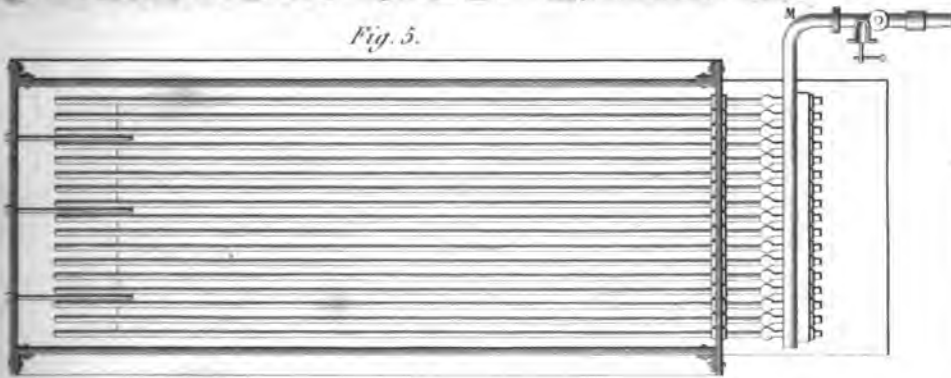
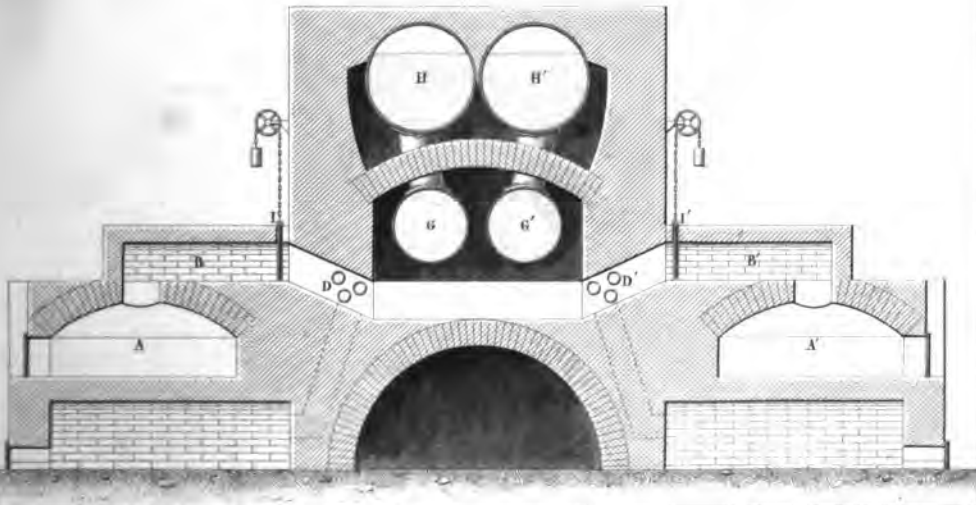


Fig. 8.





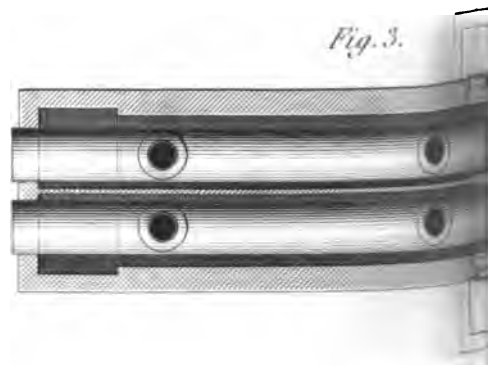
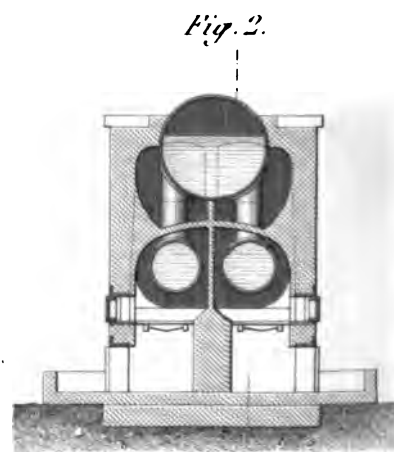
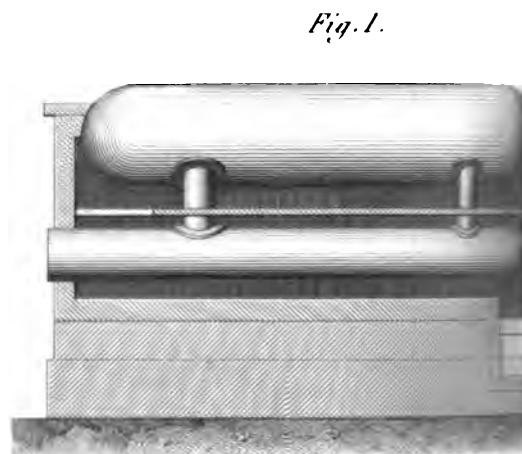
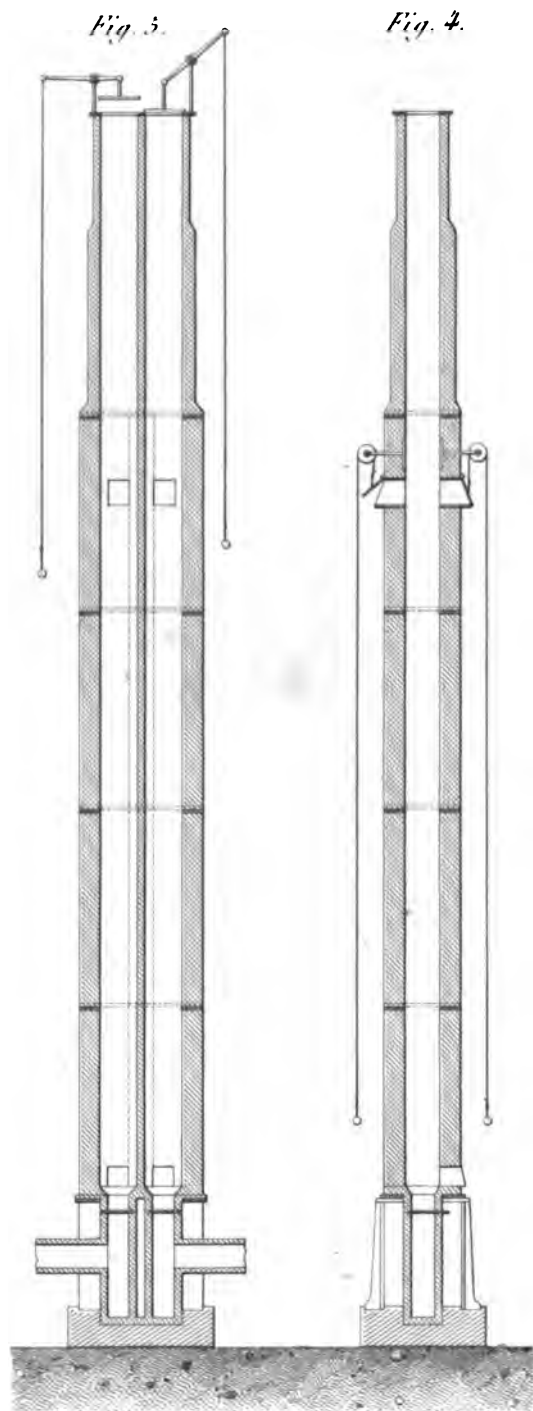


Fig. 6.

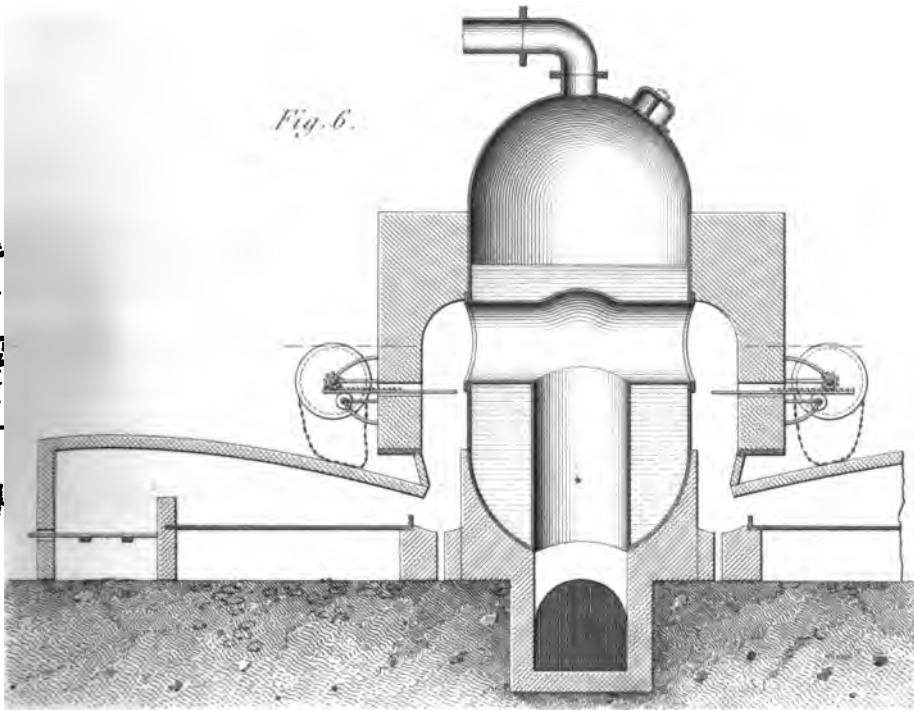
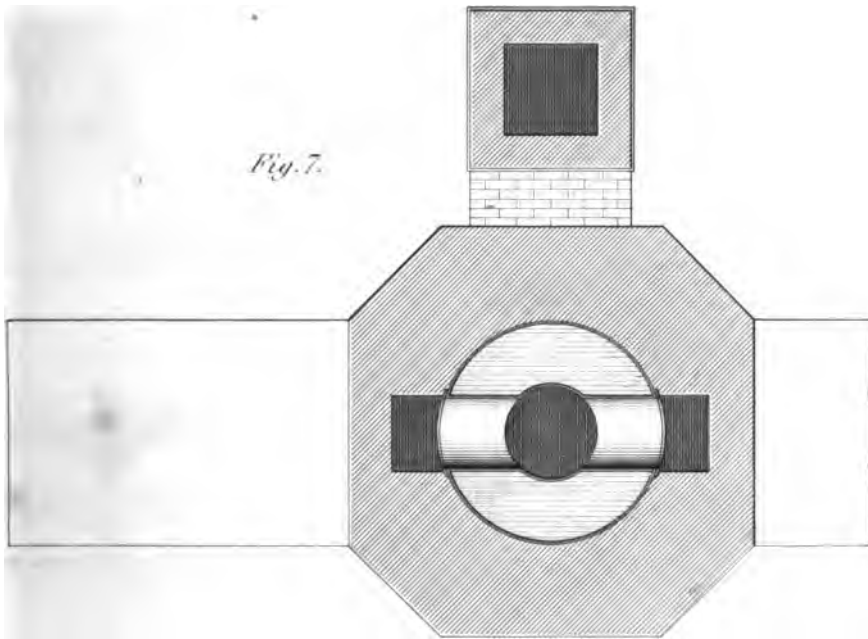
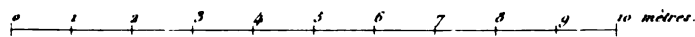
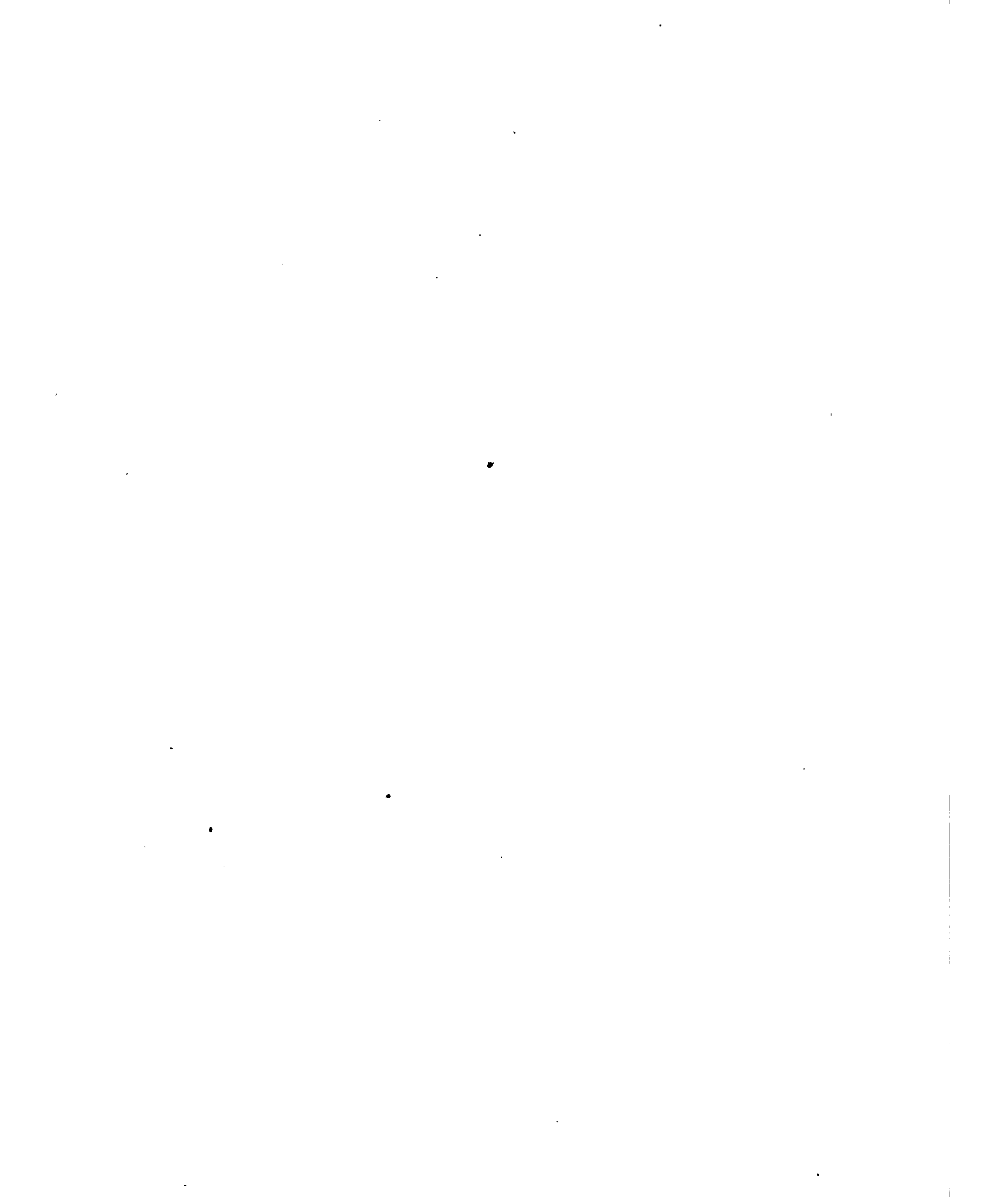


Fig. 7.



Echelle des Fig. 1, 2, 3, 4 et 5.







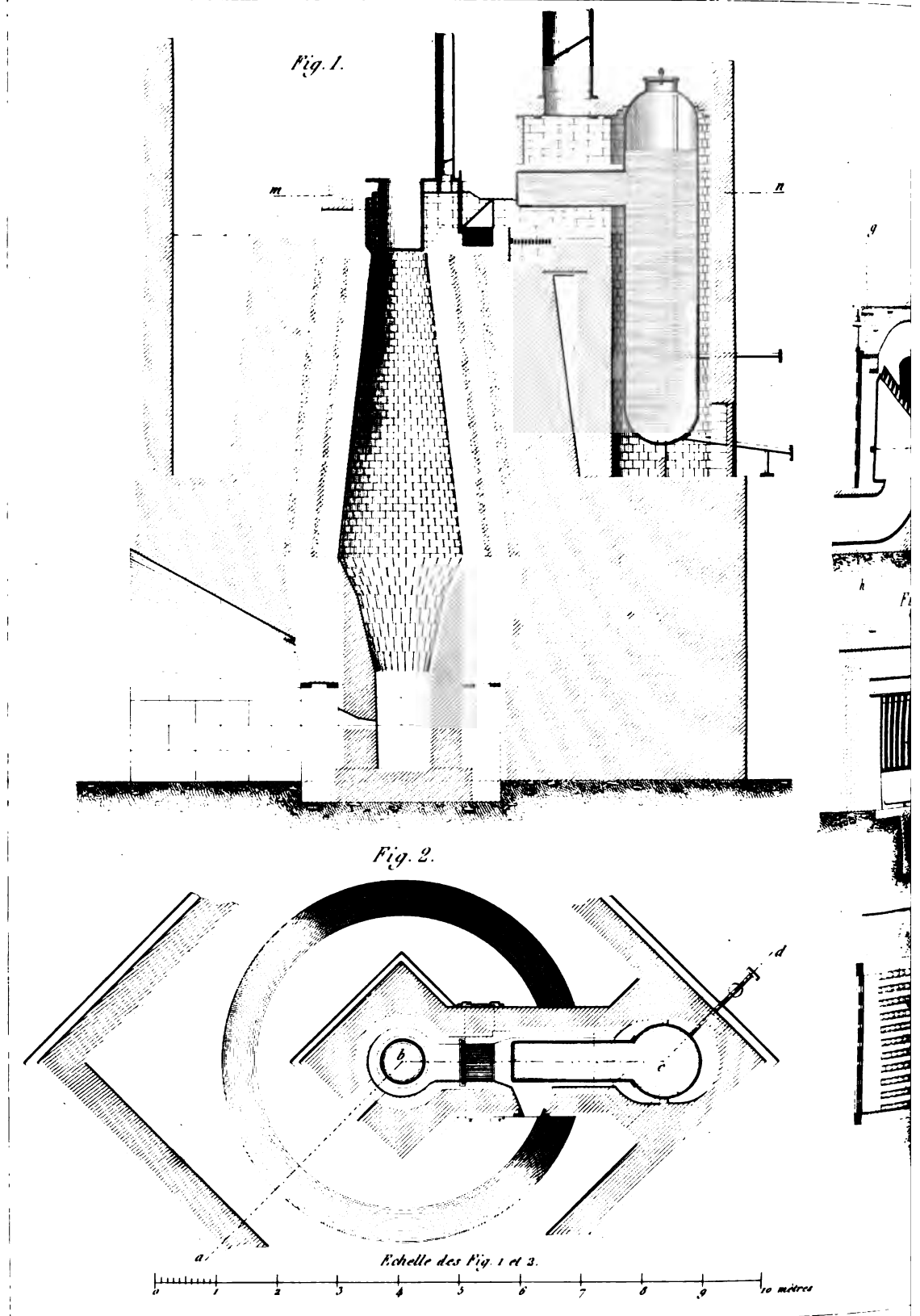


Fig. 3.

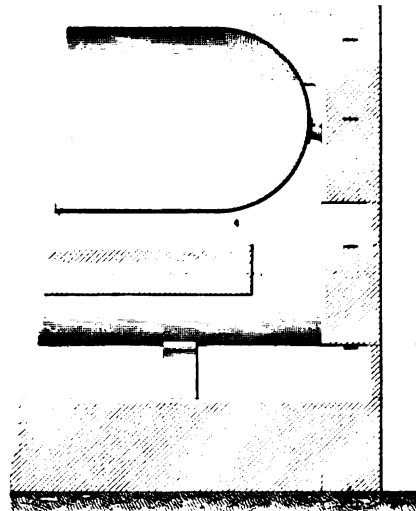
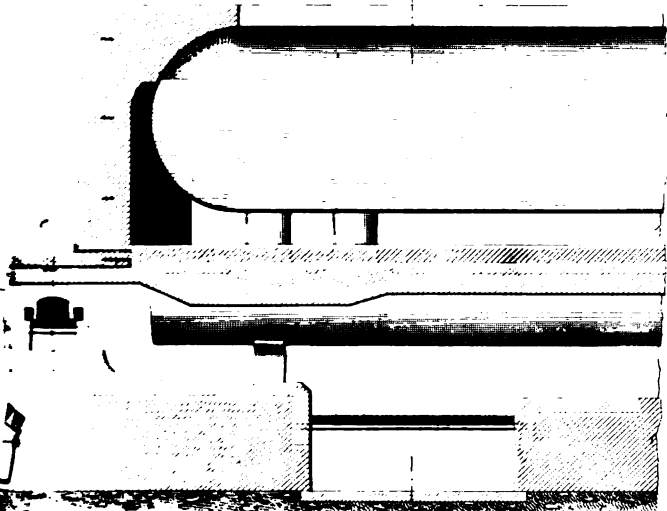


Fig. 6.

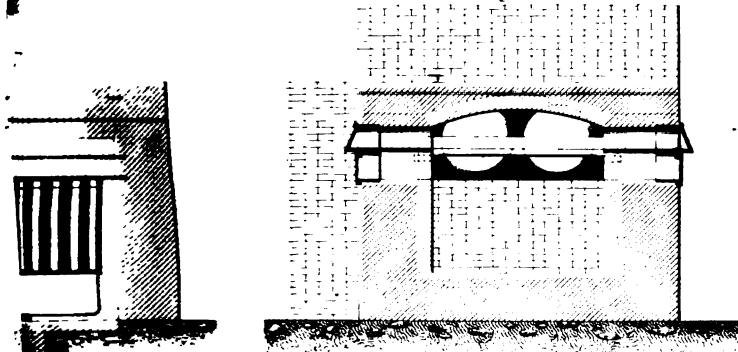


Fig. 4.

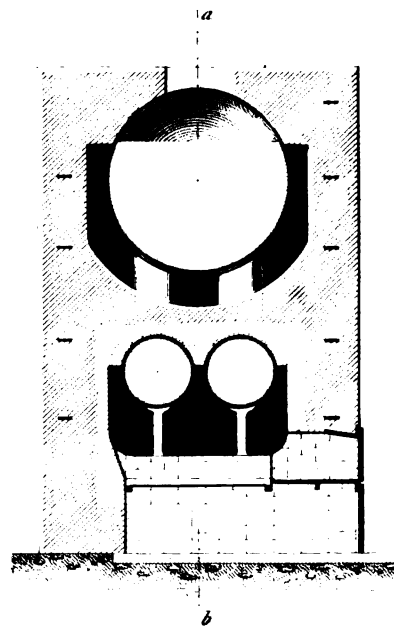
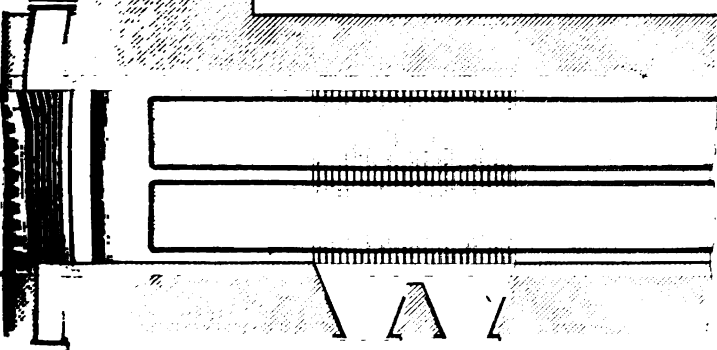
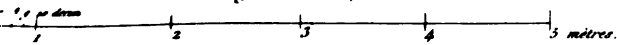


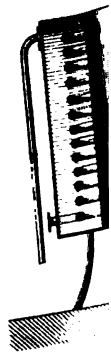
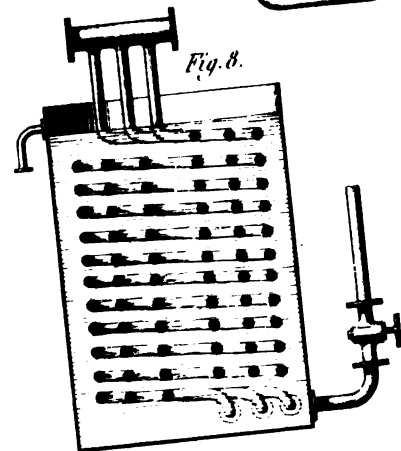
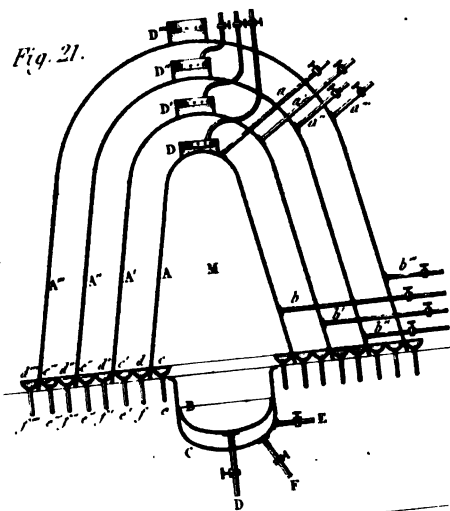
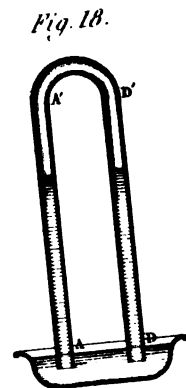
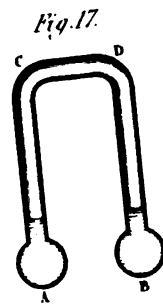
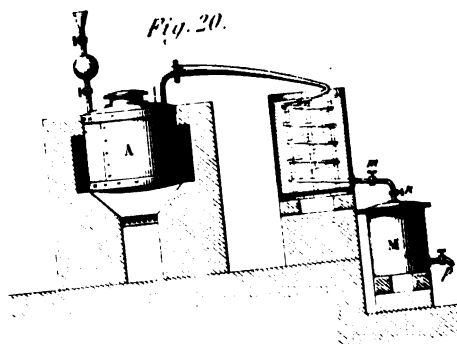
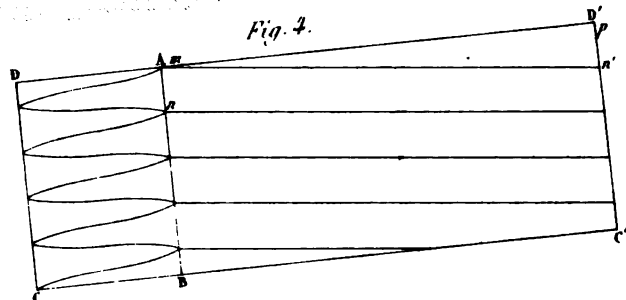
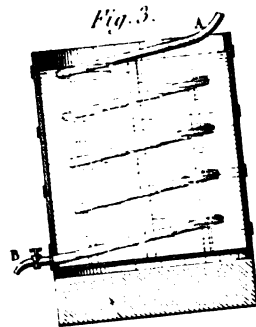
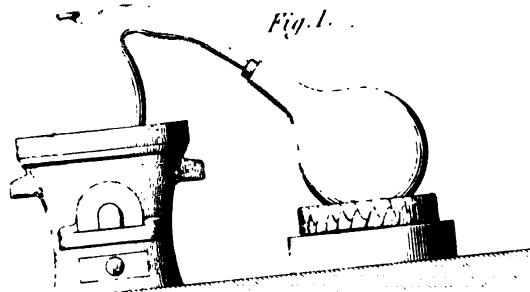
Fig. 5.

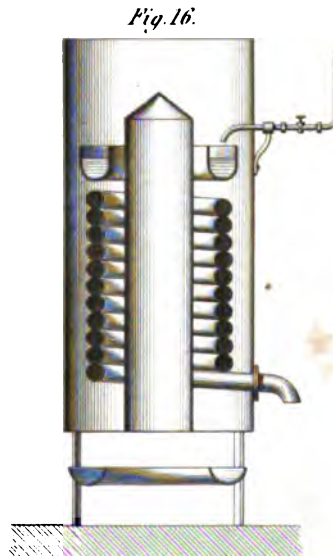
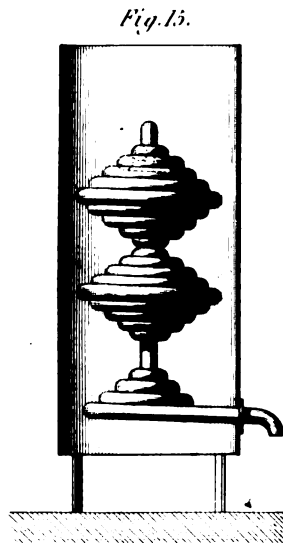
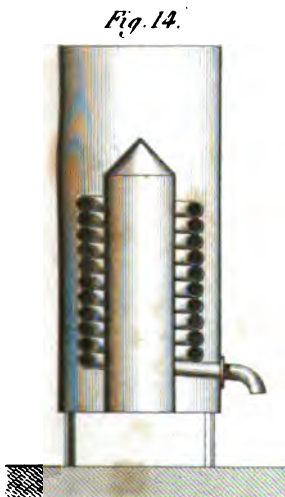
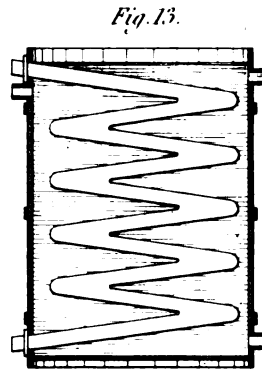
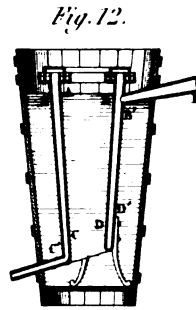
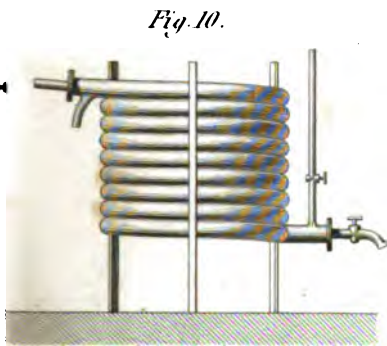
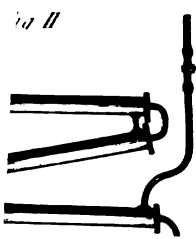
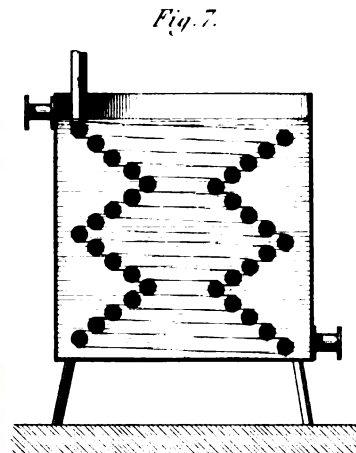
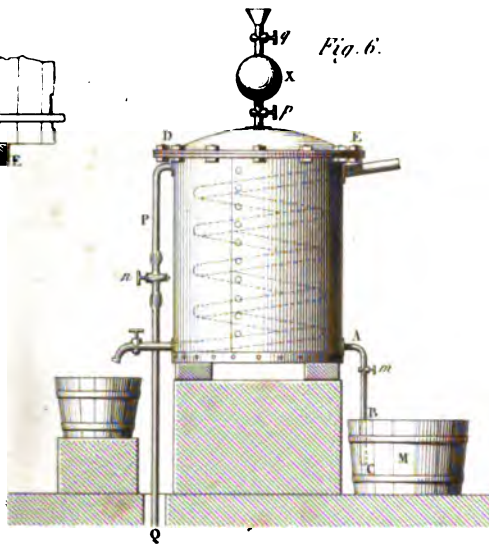
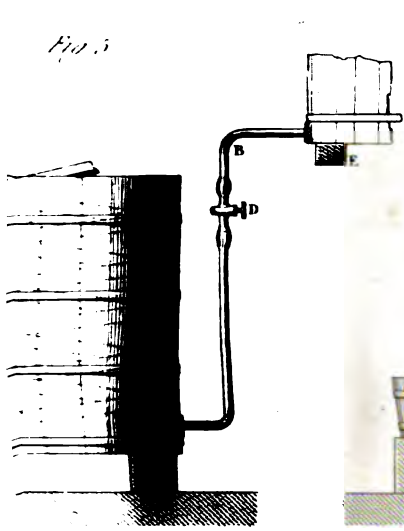


Echelle des Fig. 3, 4, 5, 6 et 7.













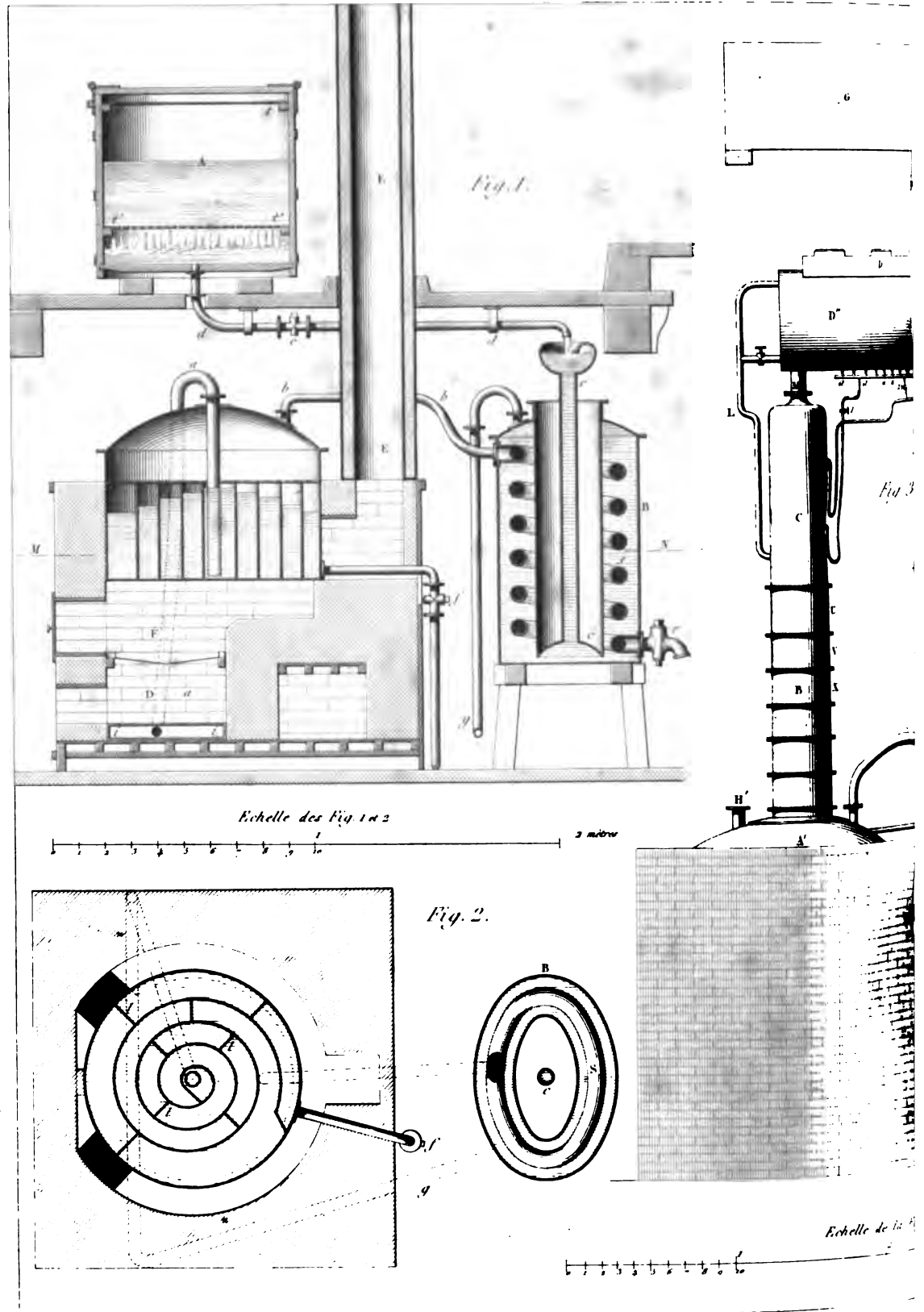


Fig. 4.

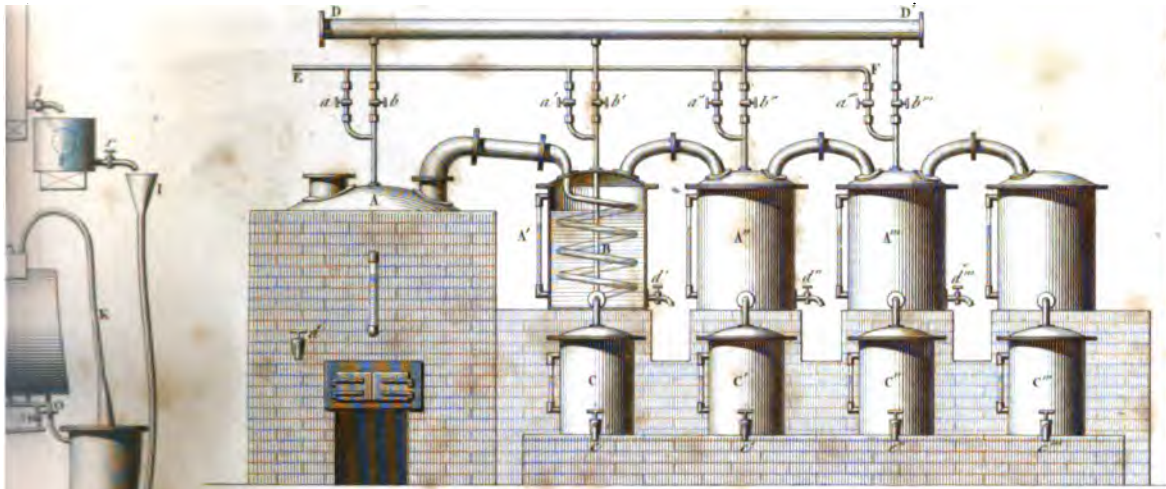
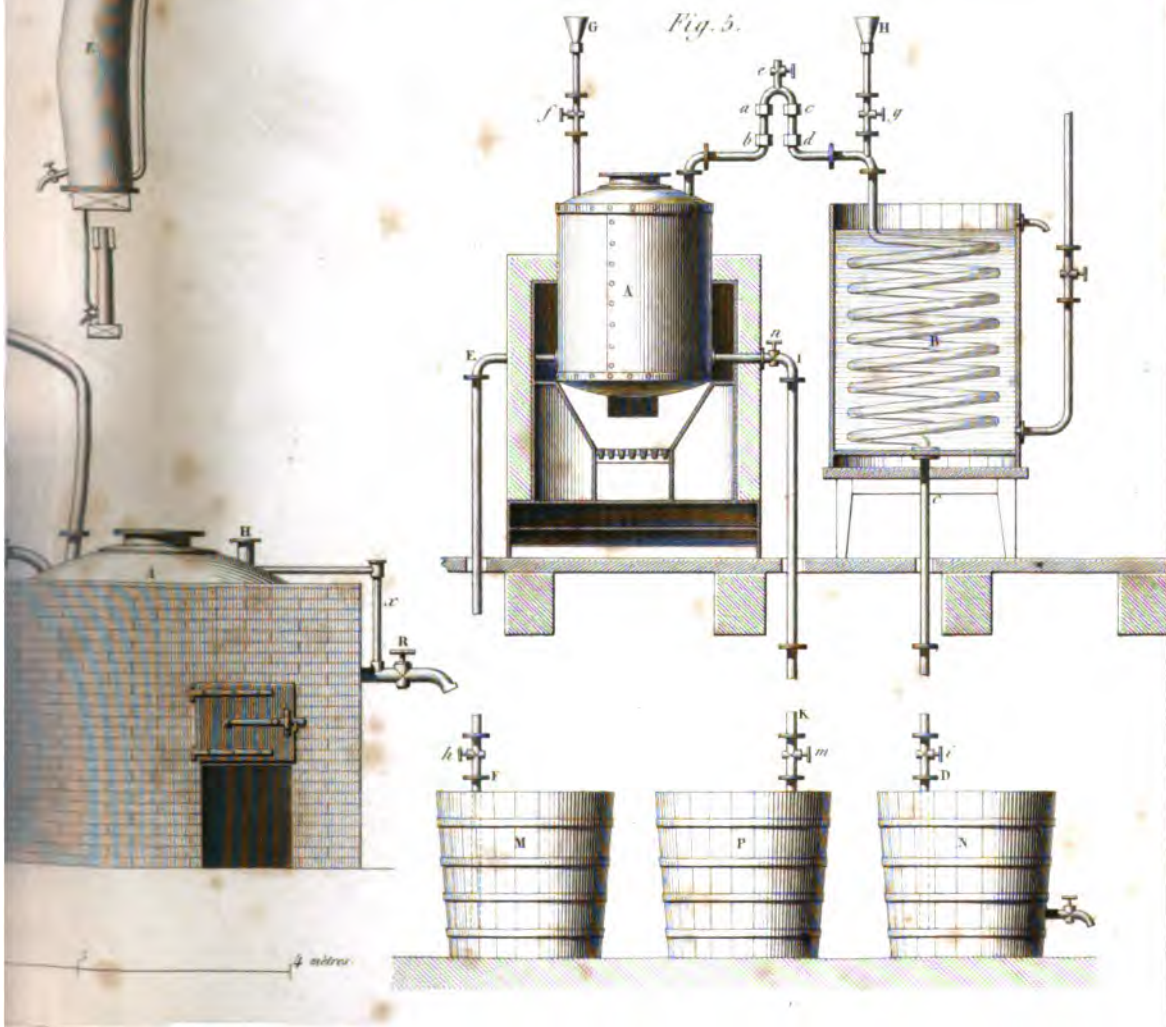
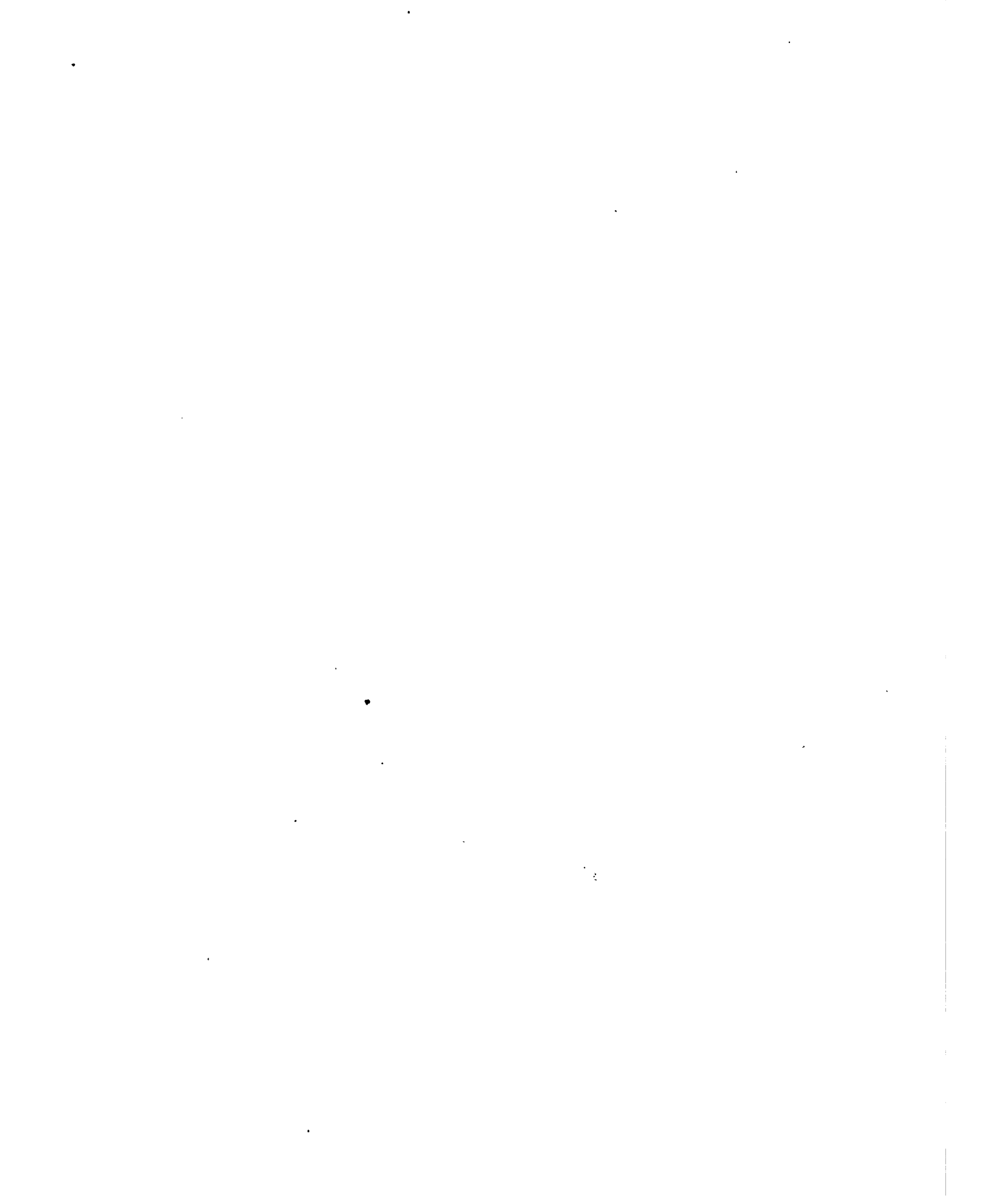
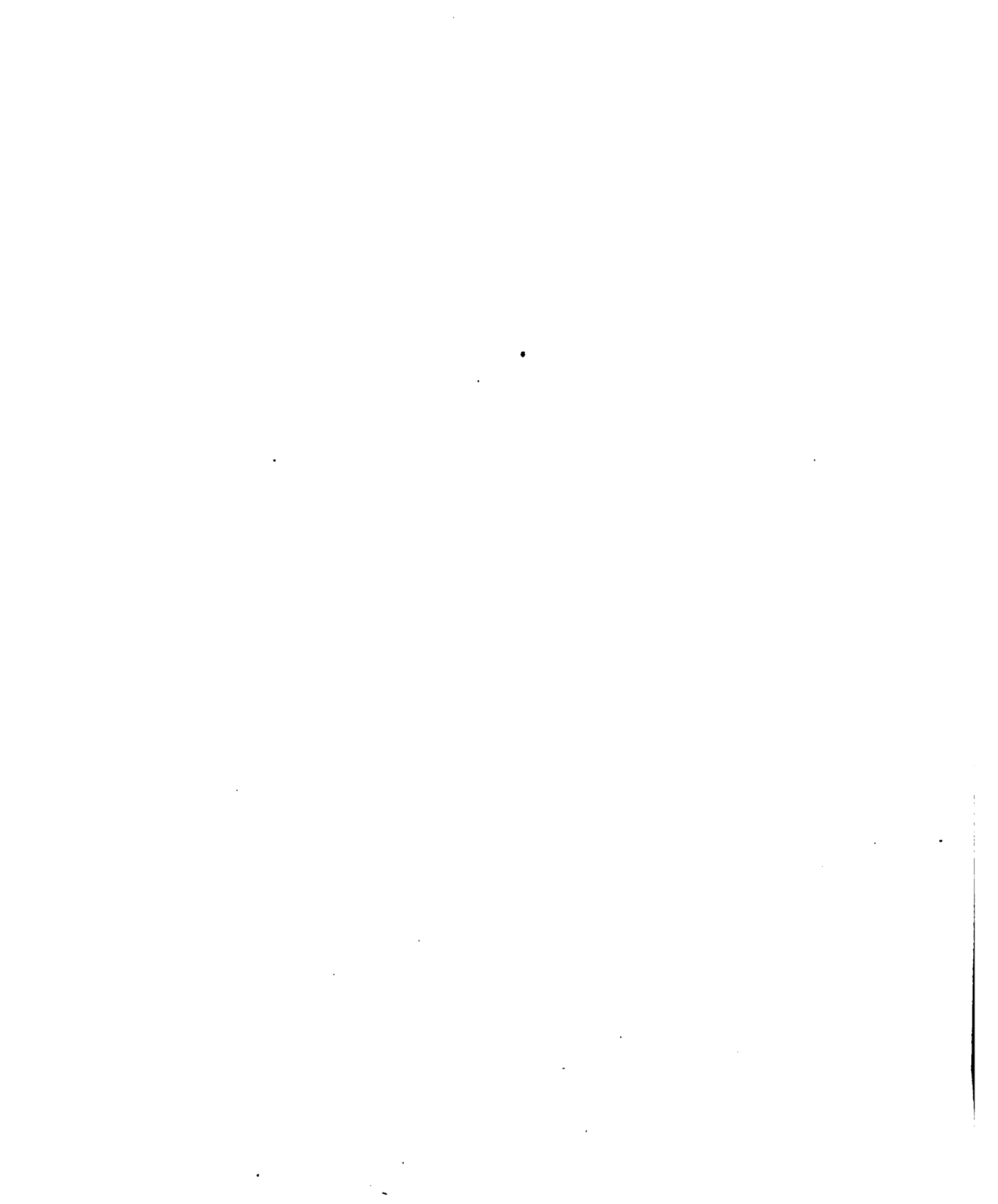


Fig. 5.



Gravé par J. Poncelet





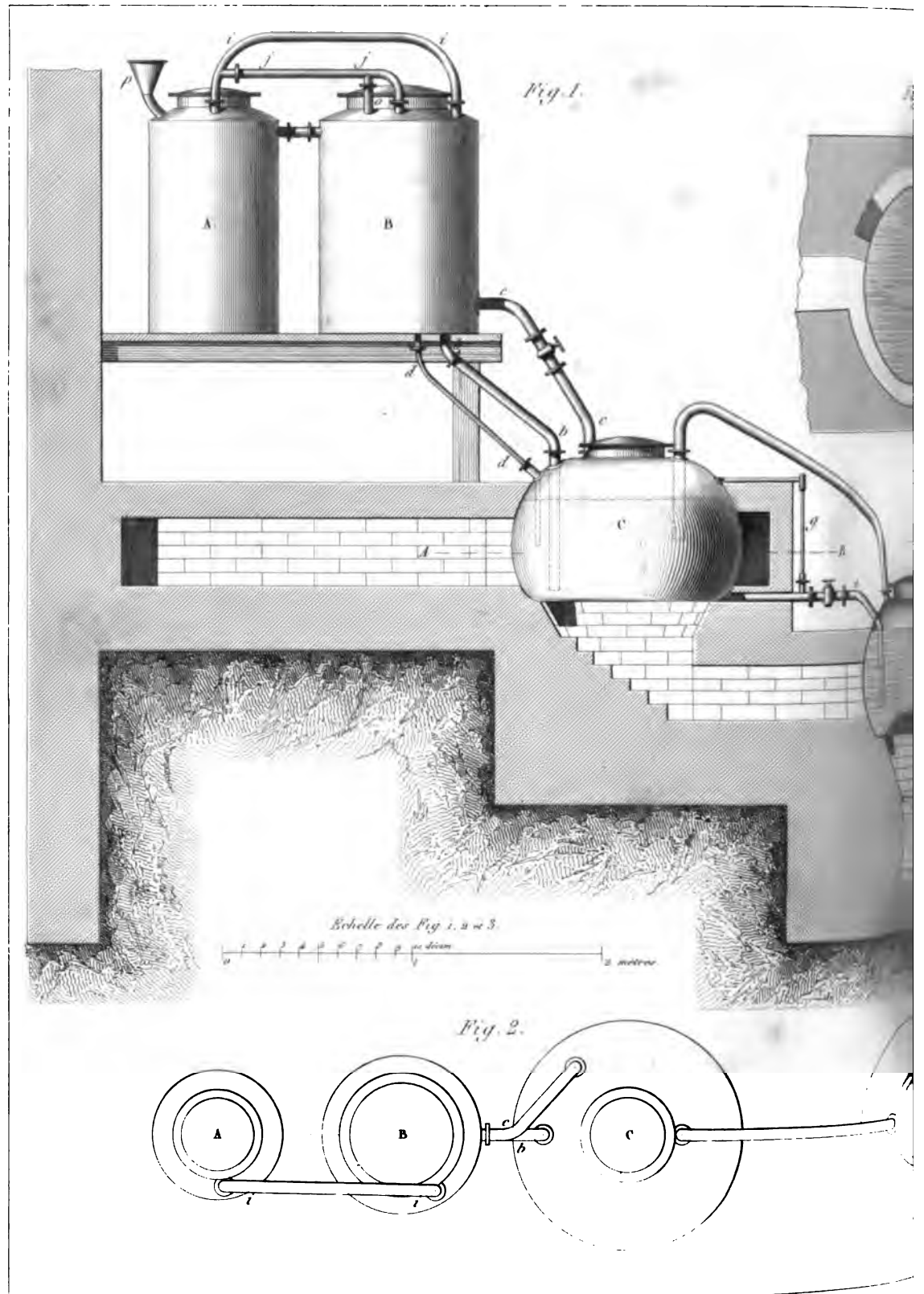


Fig. 4.

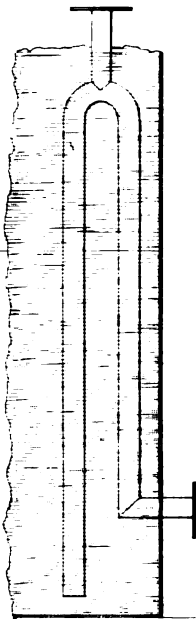


Fig. 5.

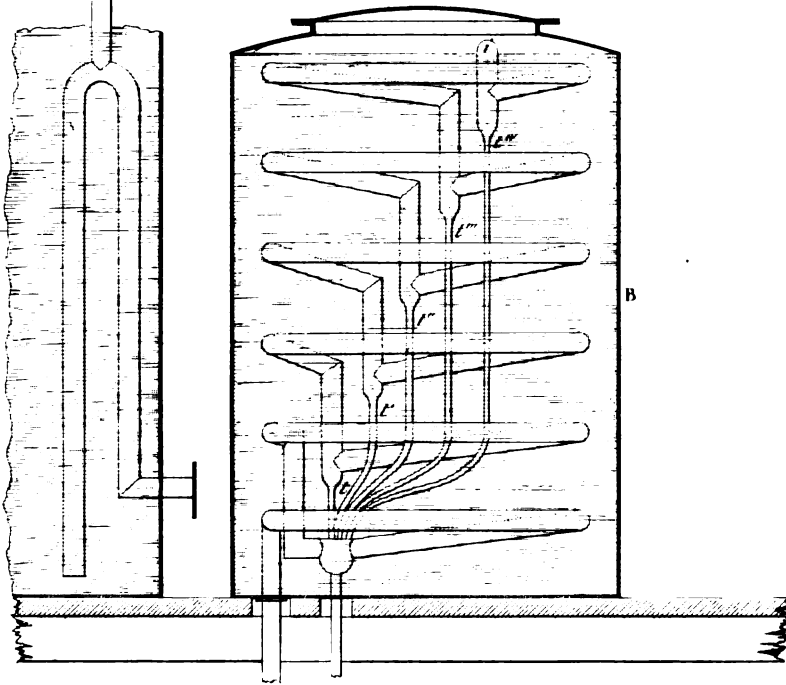
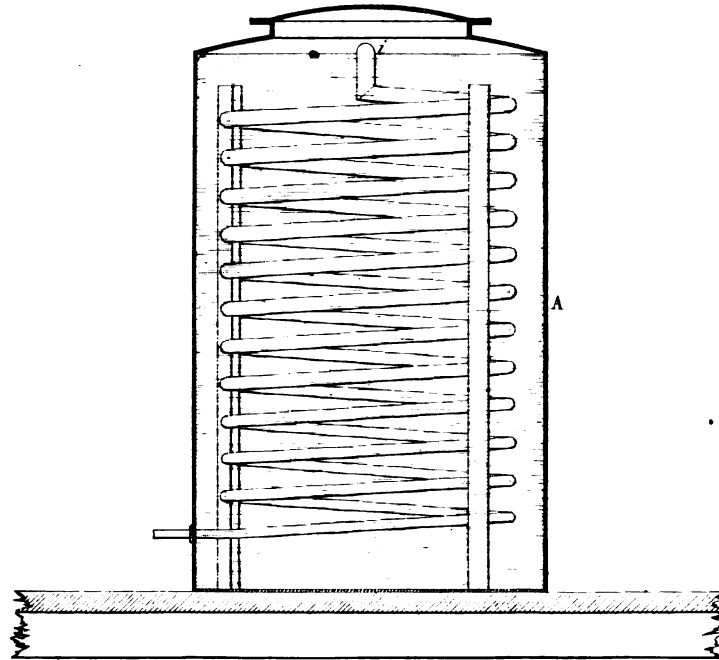


Fig. 6.



Echelle des Fig. 4, 5 et 6.

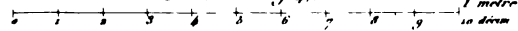
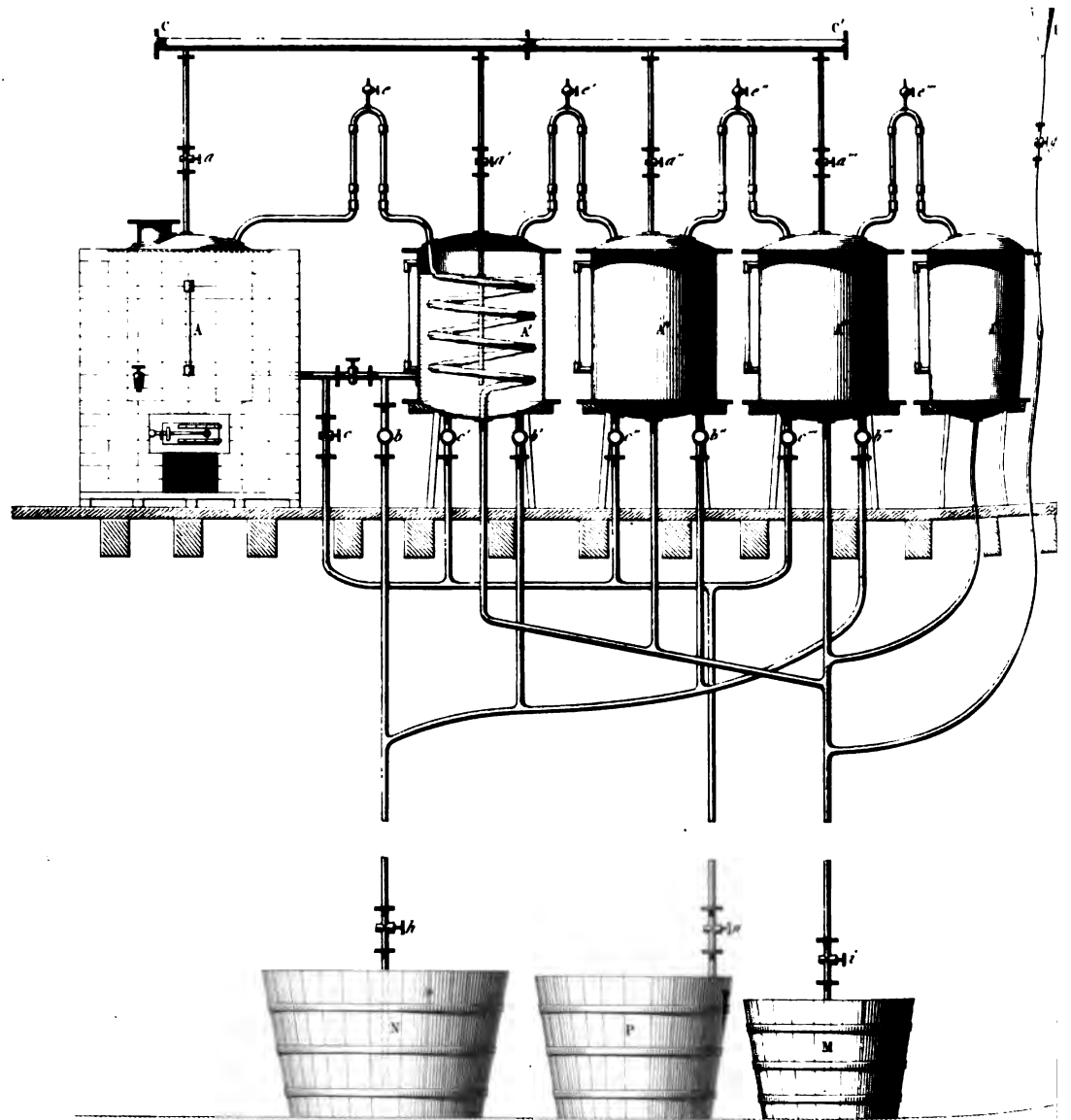






Fig. 1.



Echelle des Fig. 1 et 2.

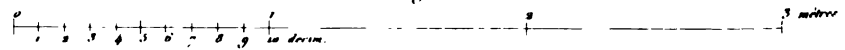


Fig. 2.

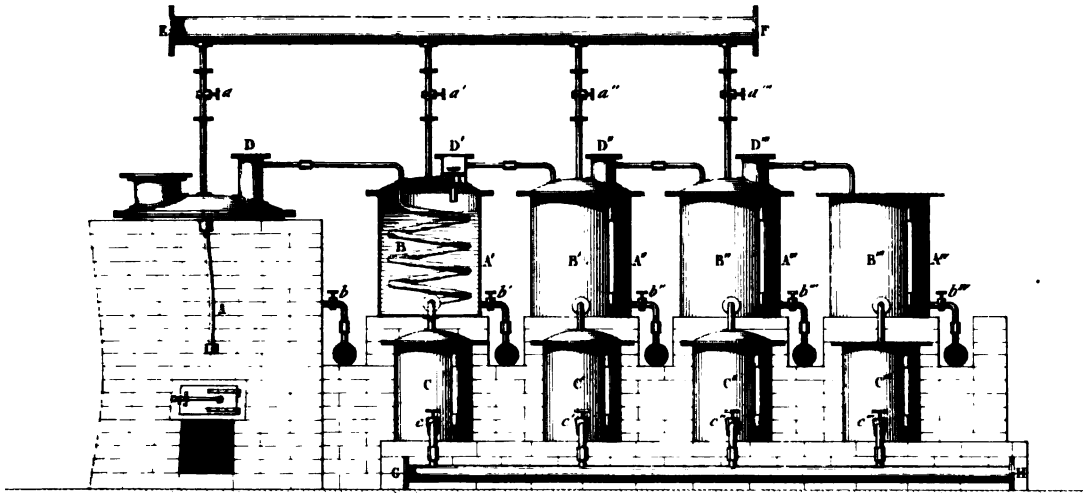


Fig. 3.

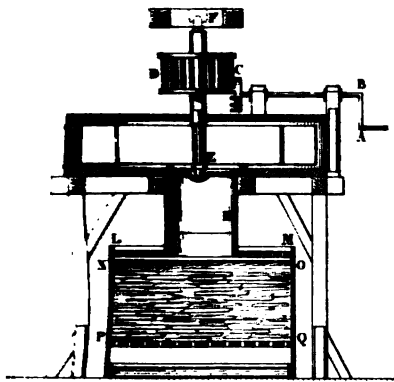


Fig. 5.

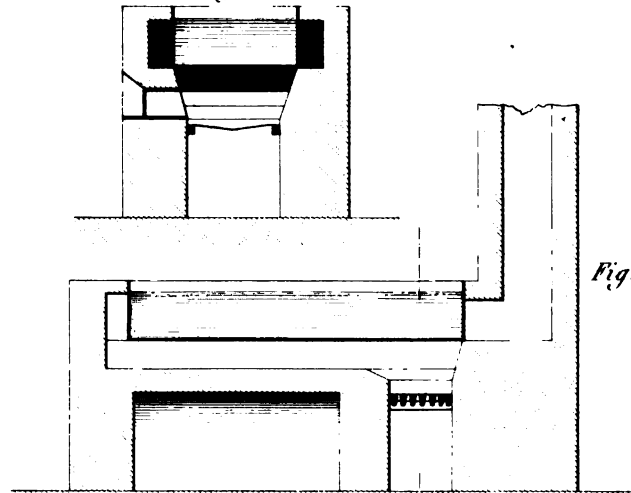


Fig. 6.

Fig. 4.

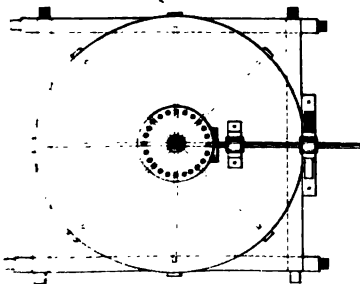


Fig. 7.

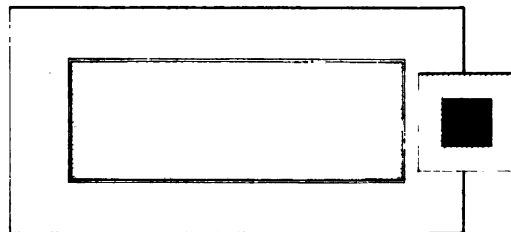






Fig. 1.

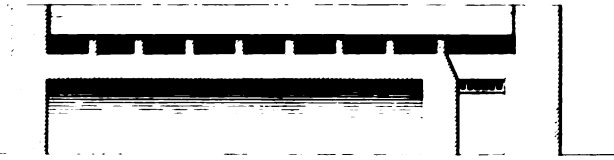


Fig. 2.

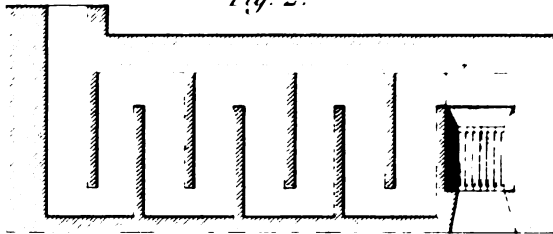


Fig. 3.

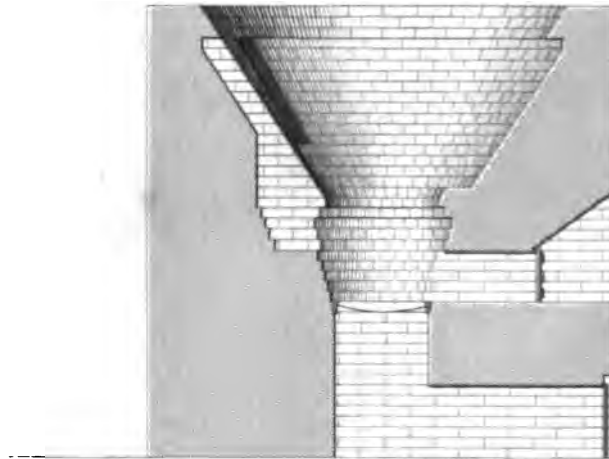
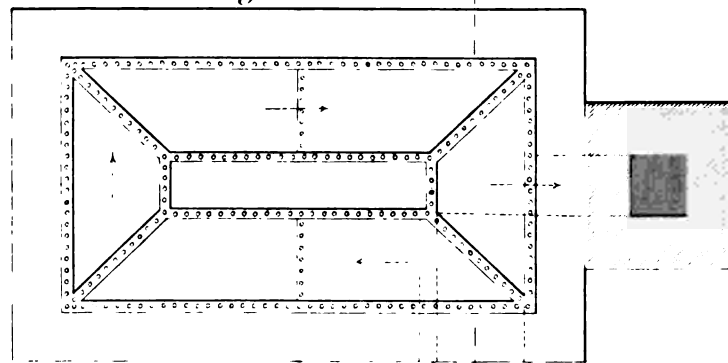


Fig. 7.



Echelle des Fig. 1 à 7

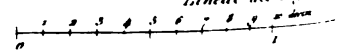


Fig. 9.

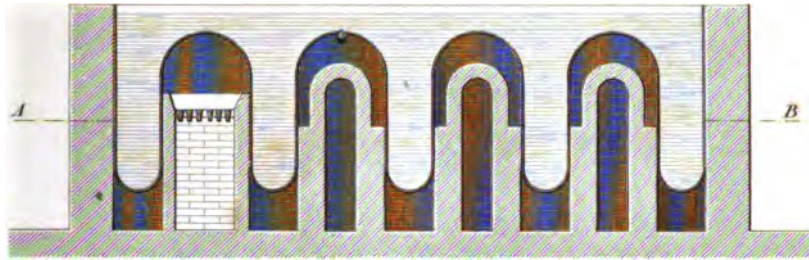


Fig. 10.

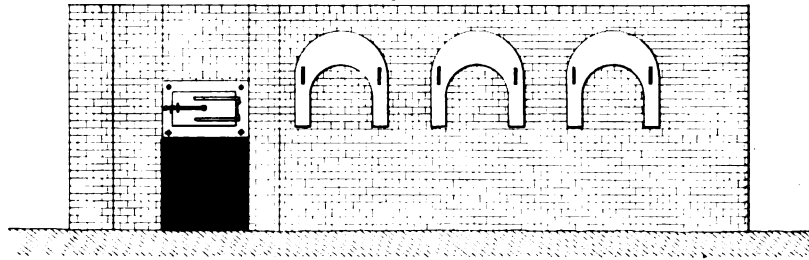
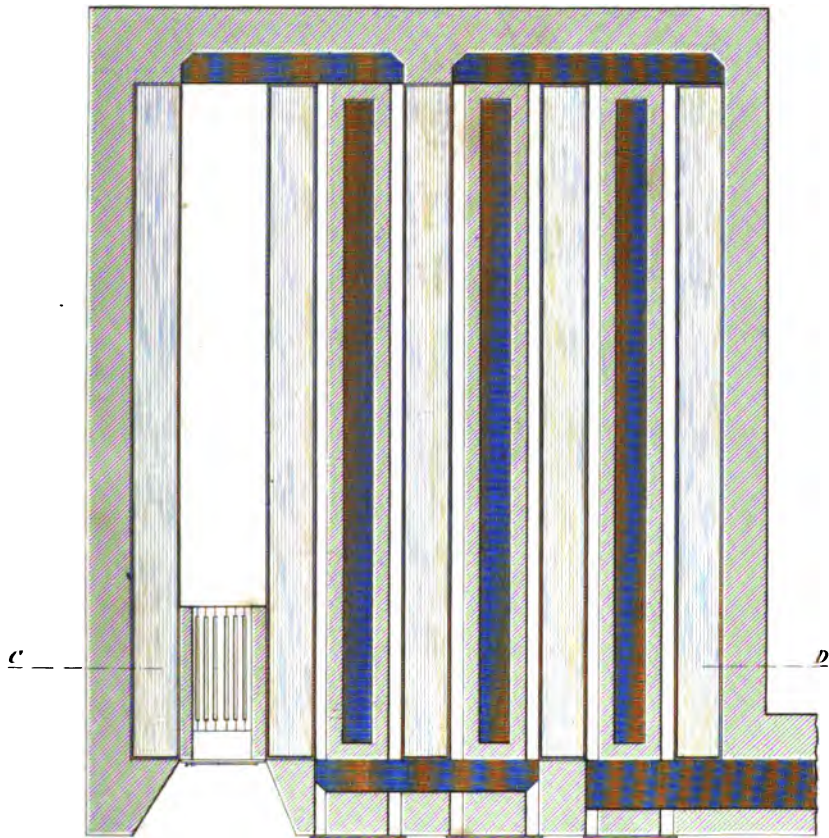
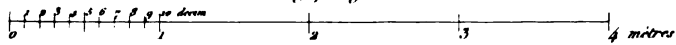


Fig. 11.



Echelle des Fig. 7, 8, 9, 10 et 11.



2 mètres

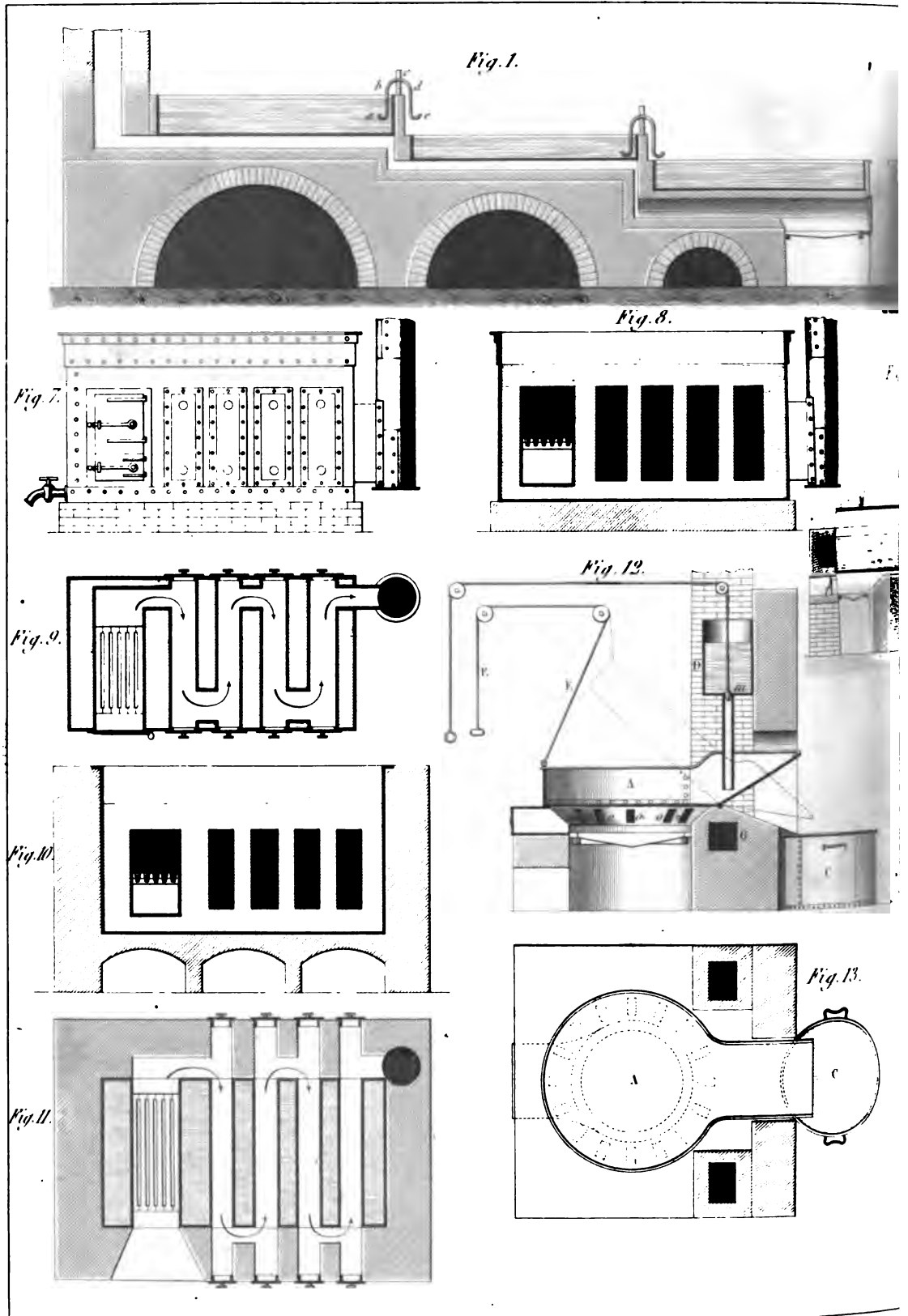


Fig. 3.

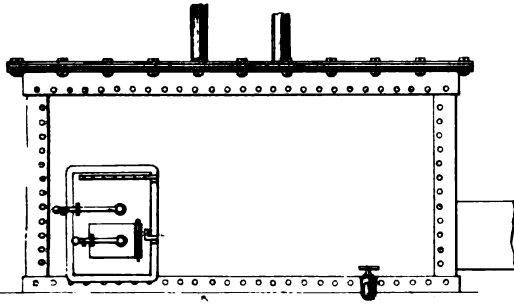


Fig. 4.

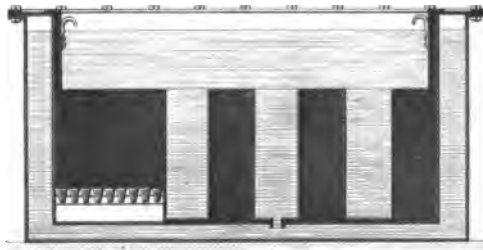


Fig. 5.

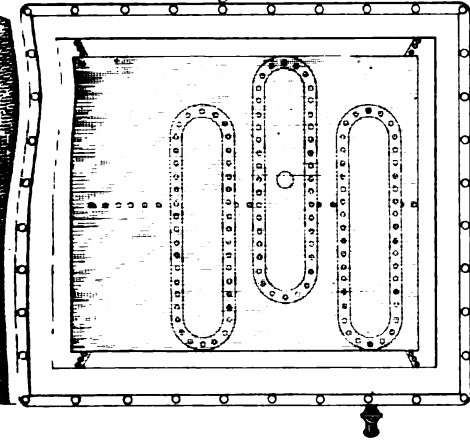


Fig. 6.

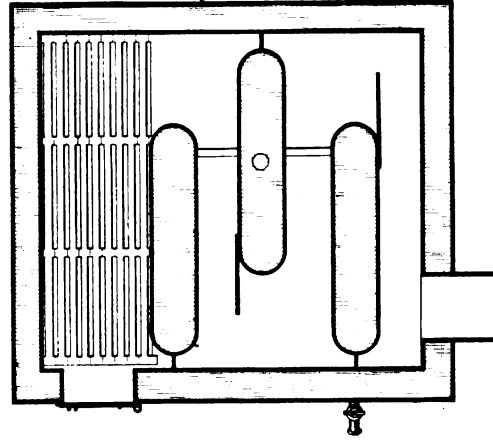


Fig. 15.



Fig. 16.

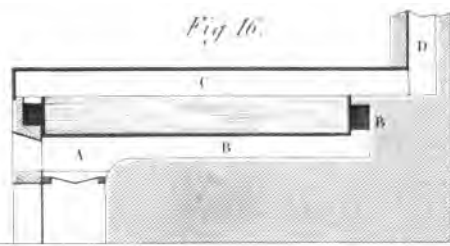


Fig. 17.

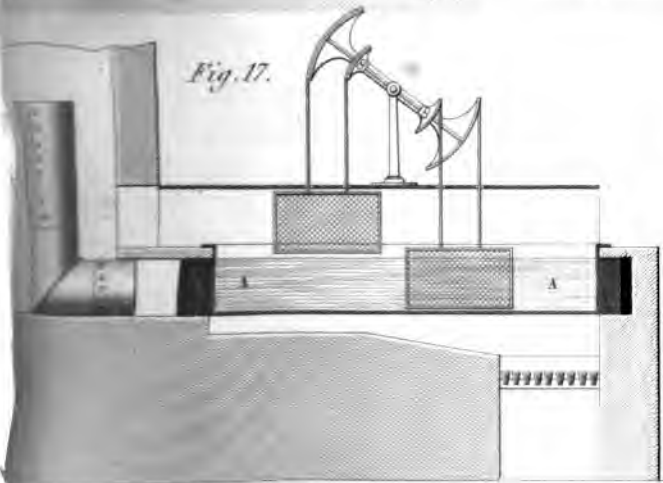
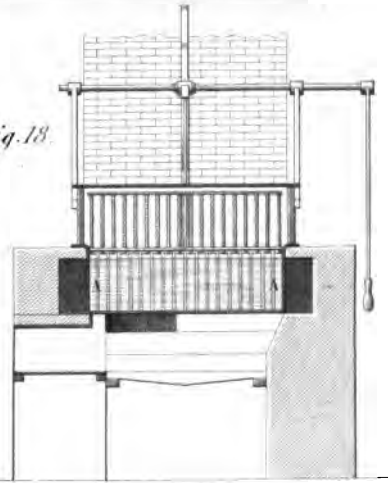
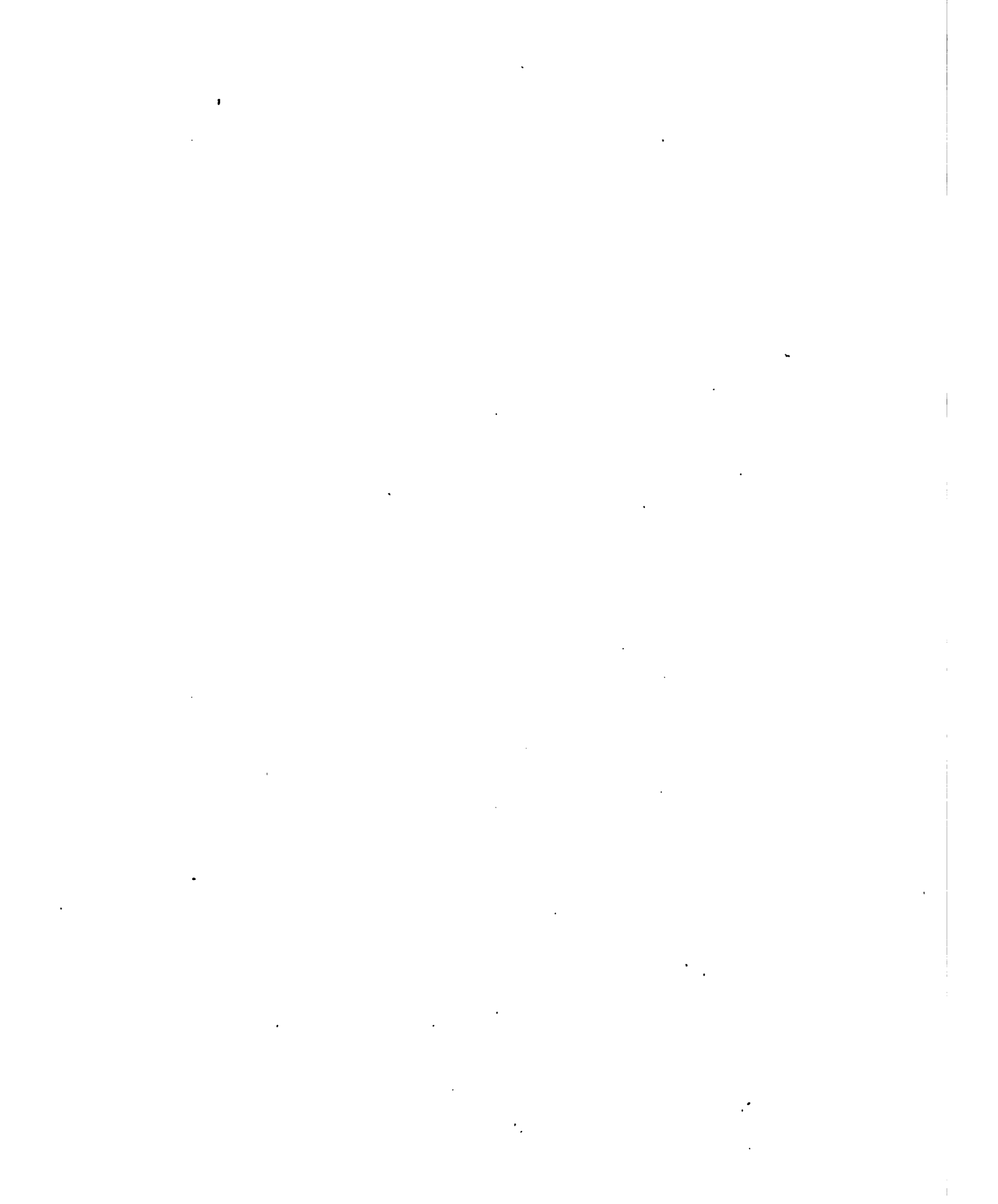


Fig. 18.





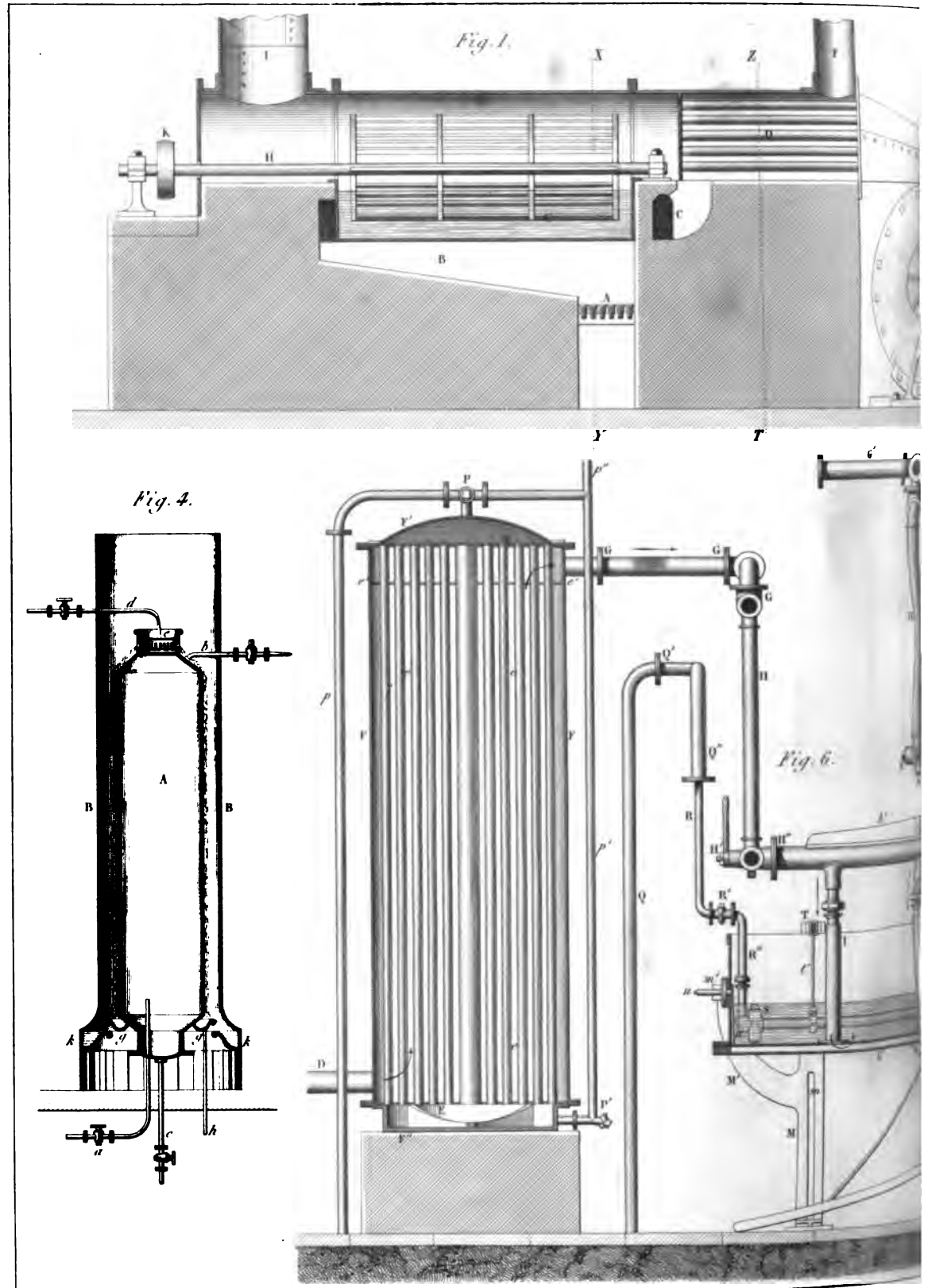


Fig. 2.

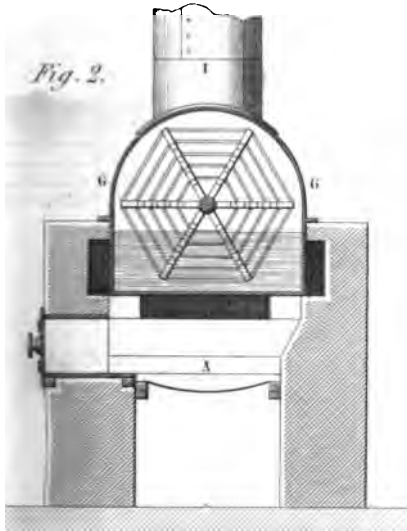


Fig. 3.

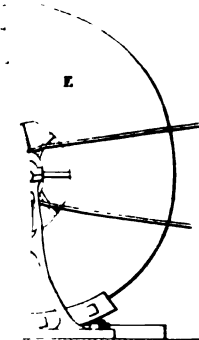
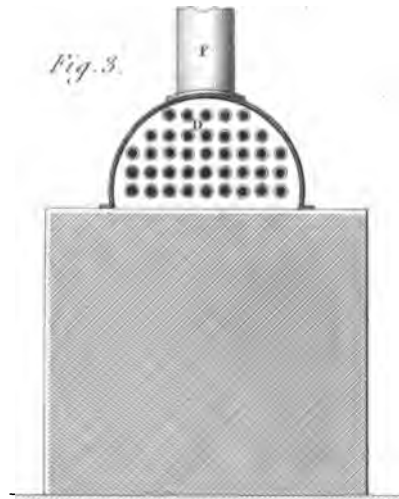


Fig. 7.



Fig. 5.

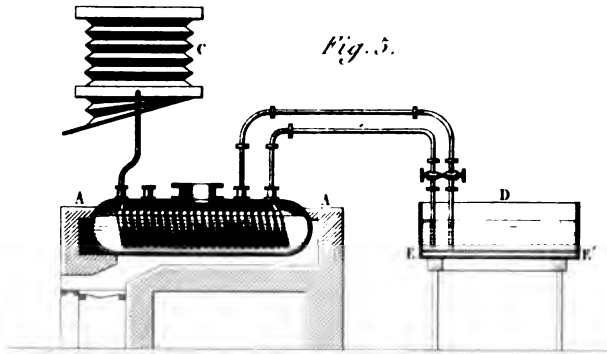
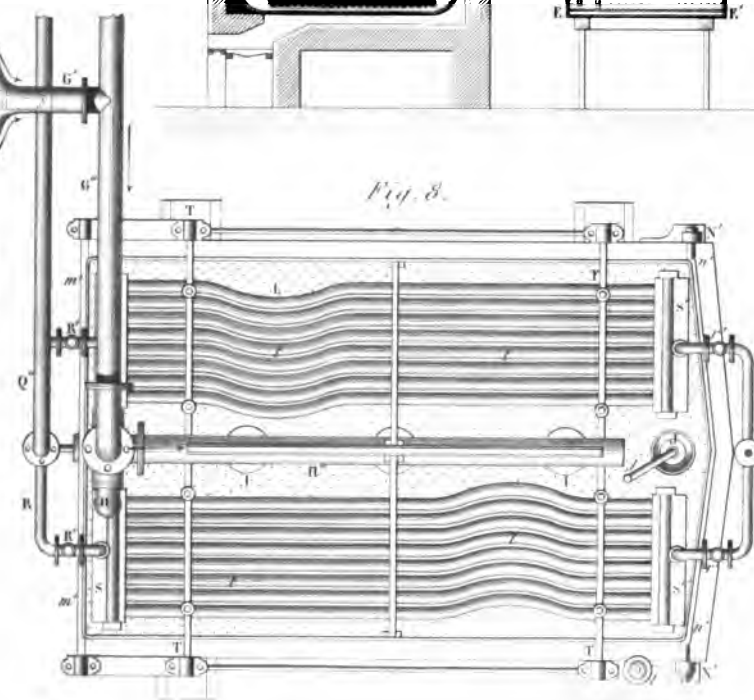
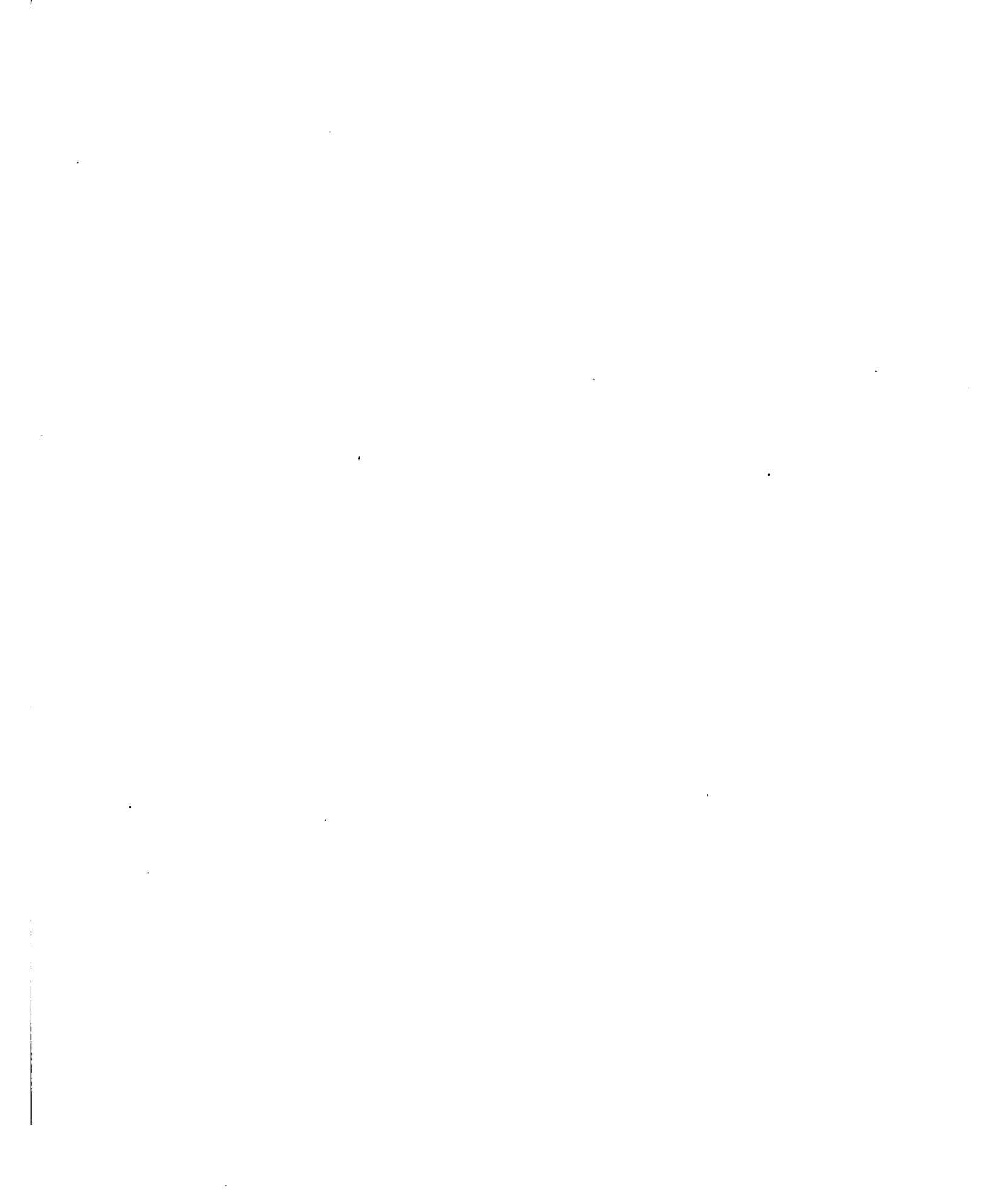
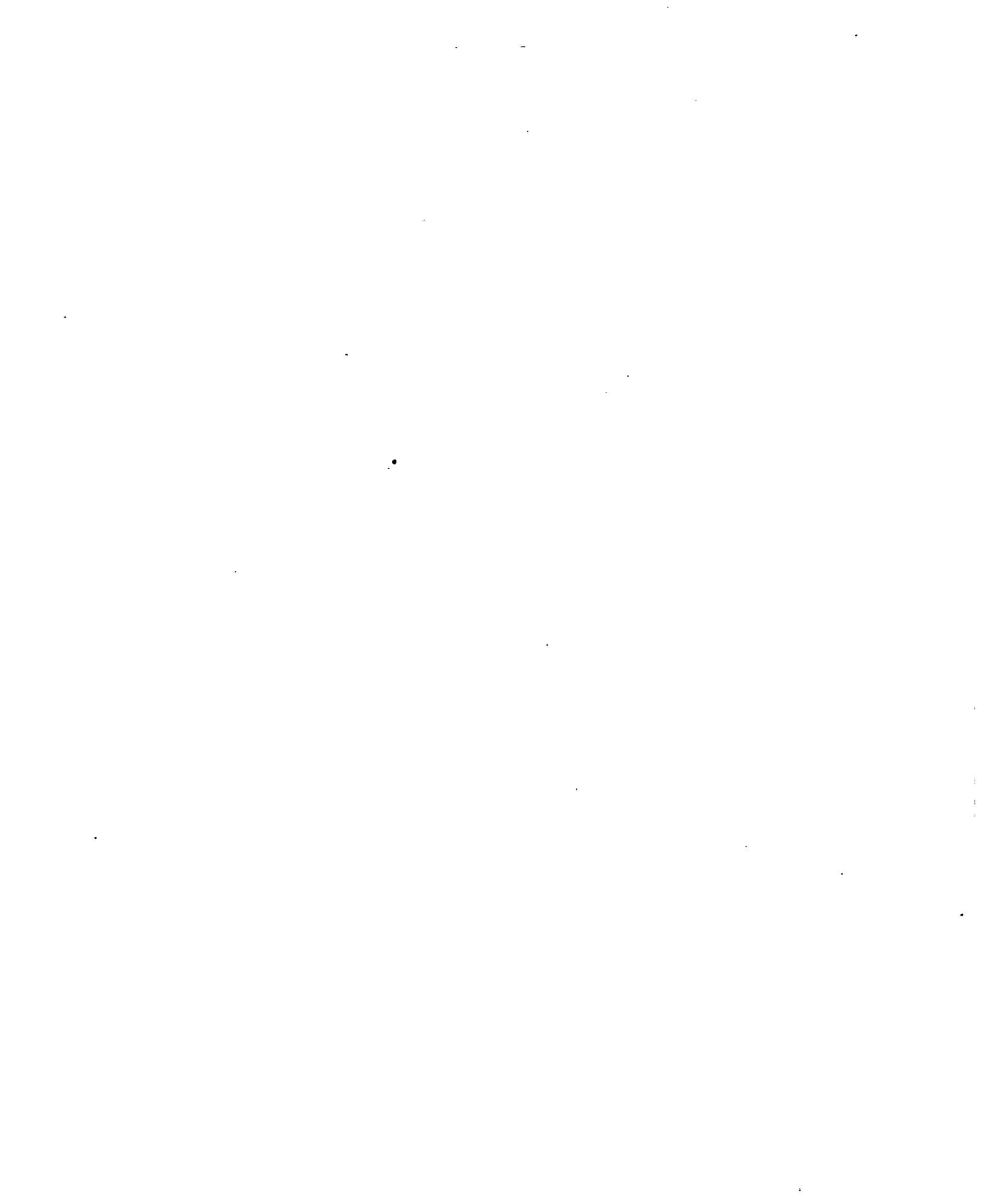


Fig. 8.







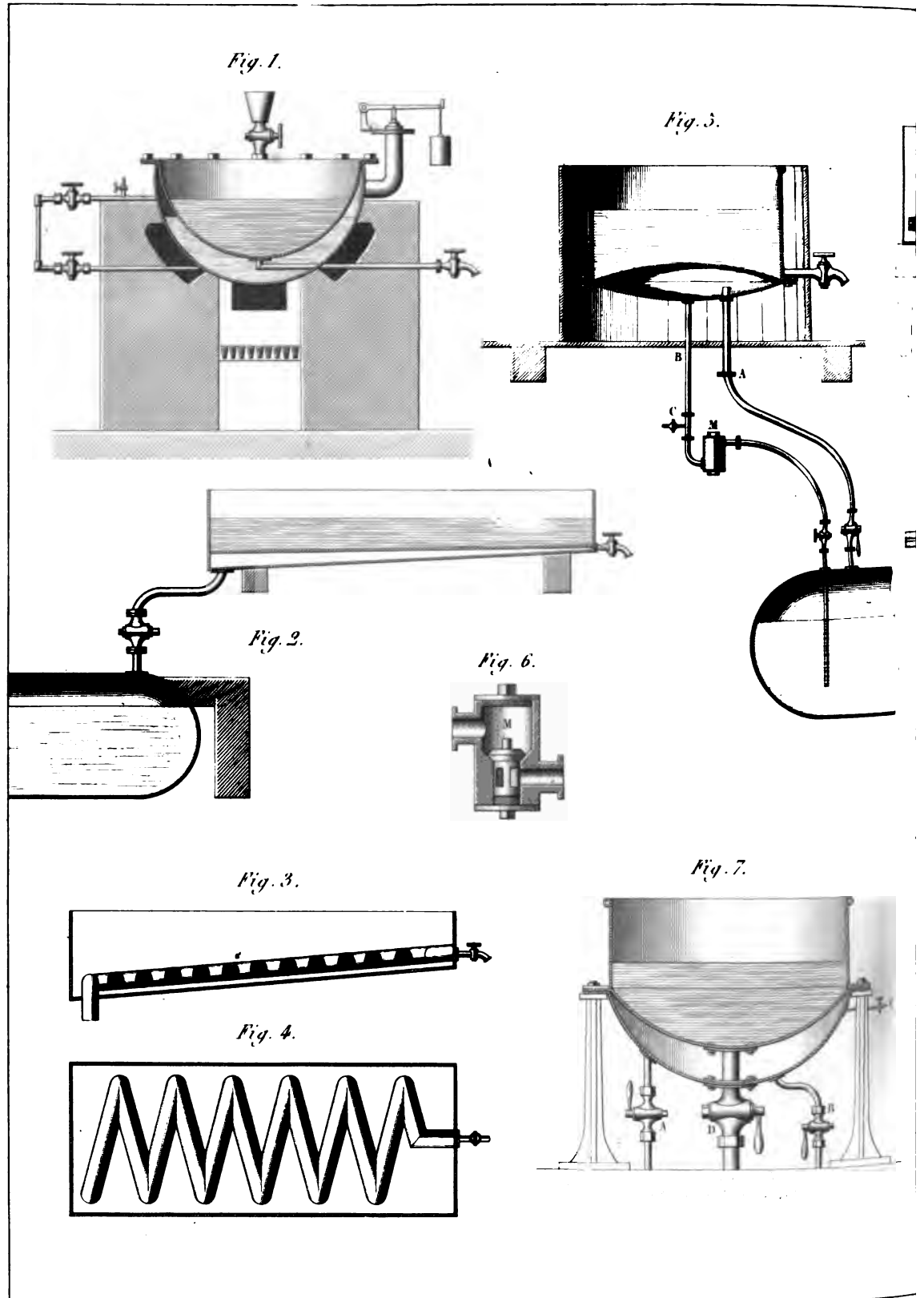


Fig. 10.

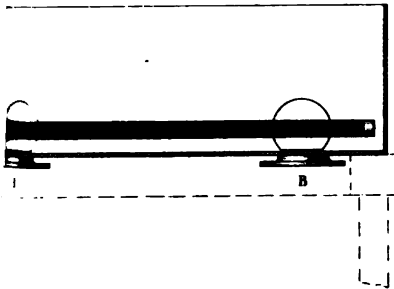


Fig. 11.

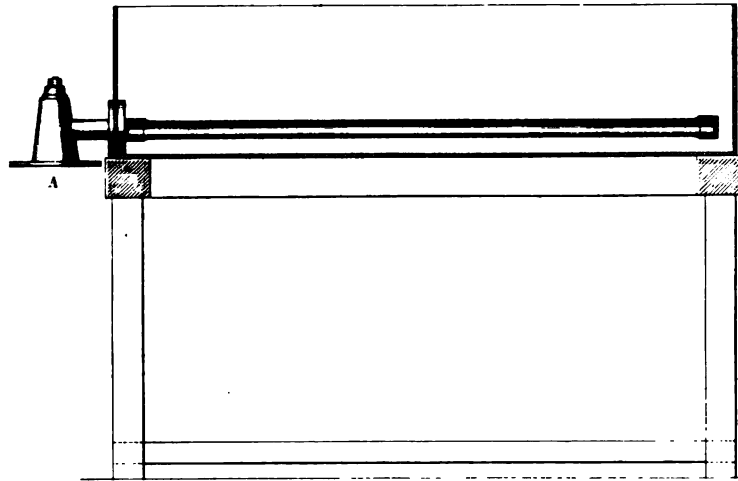


Fig. 13.

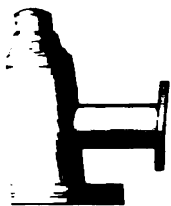


Fig. 14.

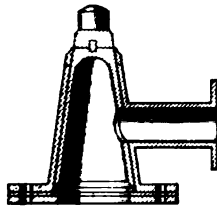


Fig. 15.

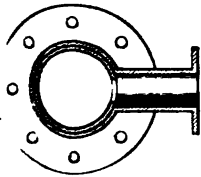


Fig. 12.

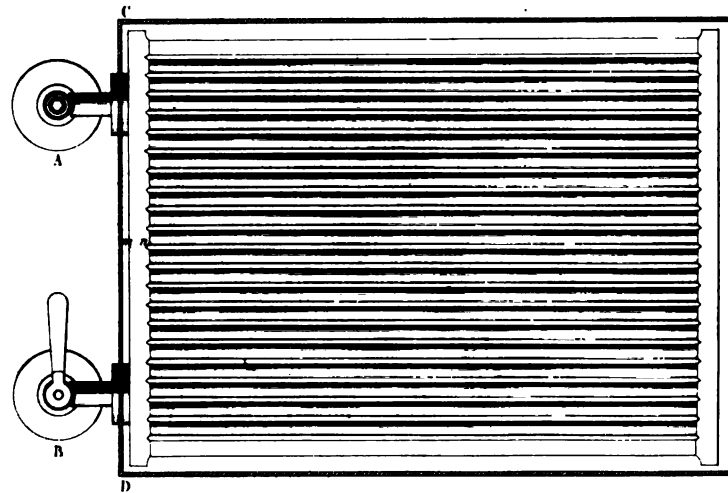
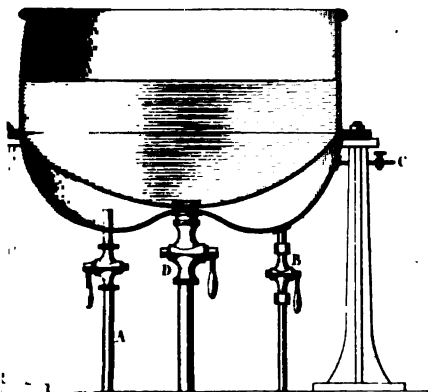
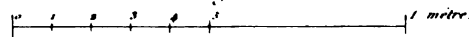
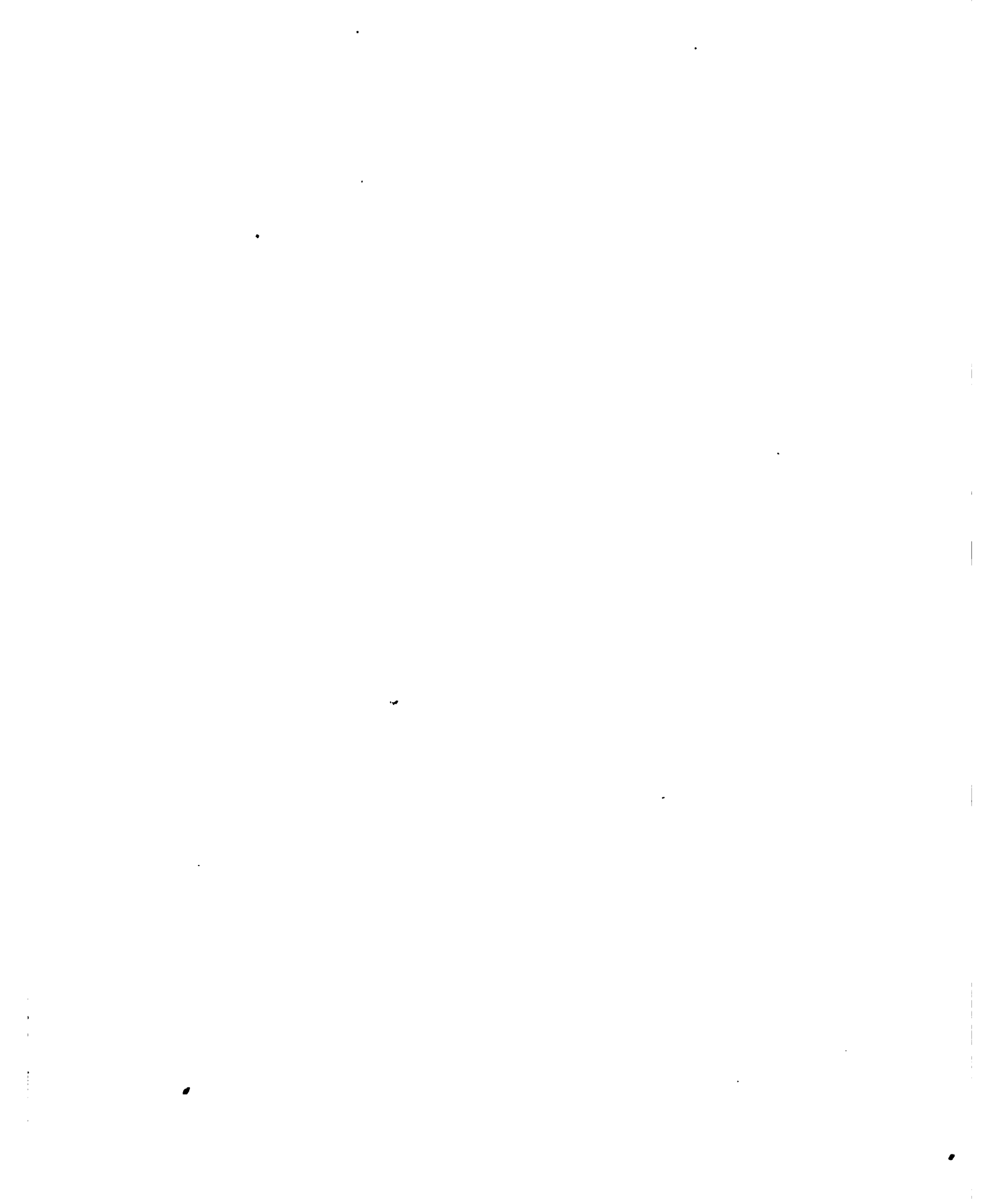


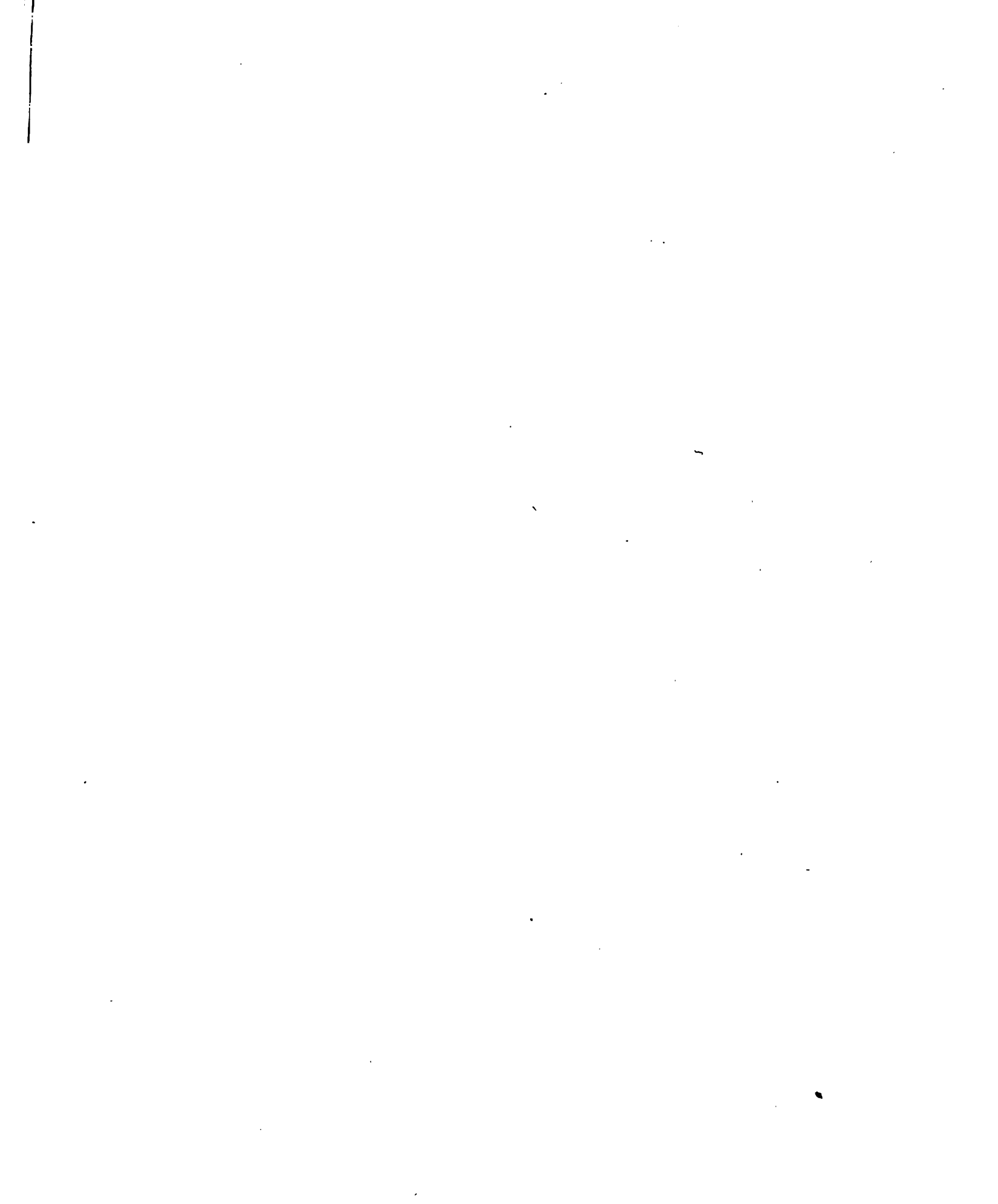
Fig. 8.



Echelle des Fig 10 et 12.







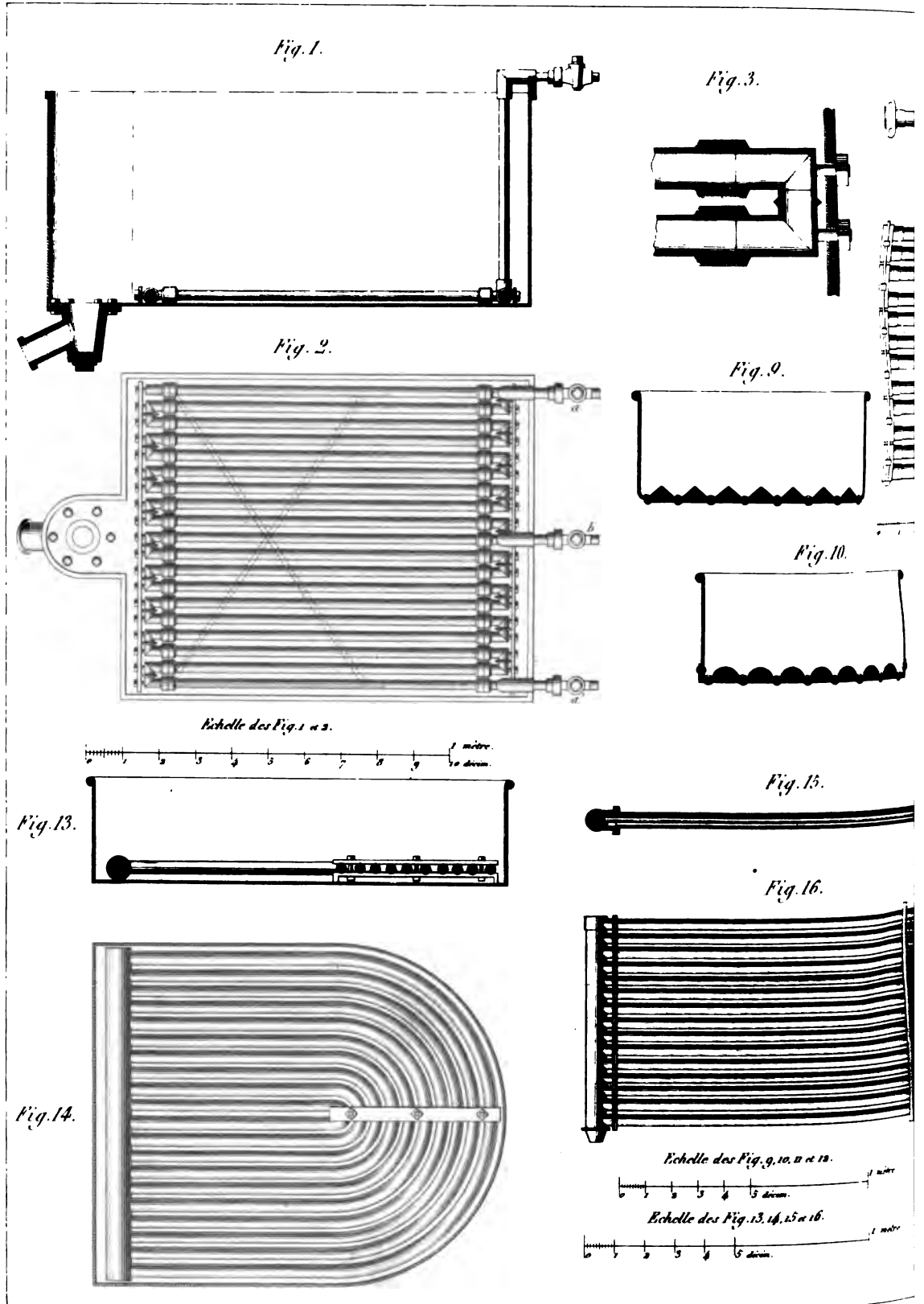


Fig. 5.

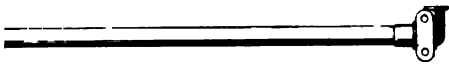
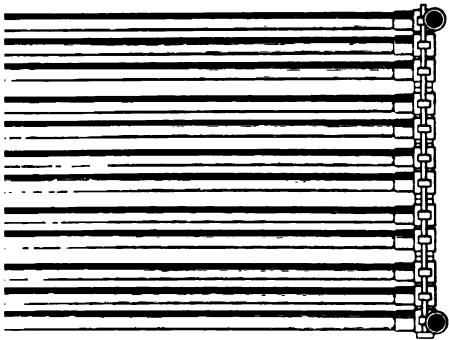


Fig. 4.



Echelle des Fig. 4 et 5.

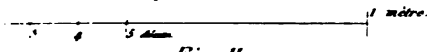


Fig. 11.

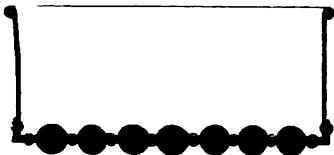


Fig. 12.



Fig. 17.

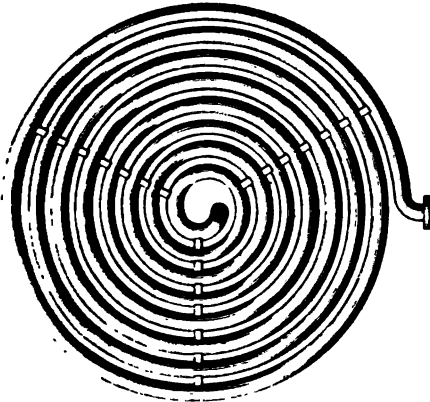


Fig. 6.



Fig. 7.

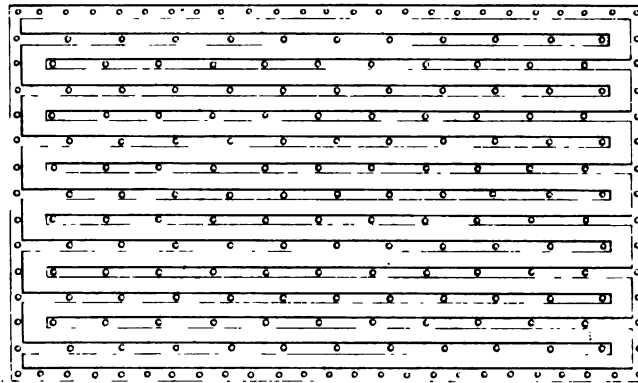
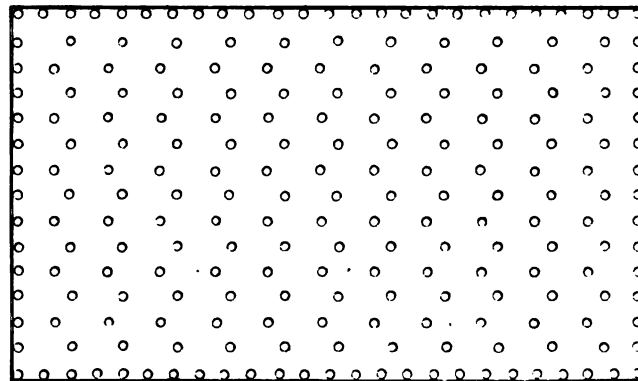
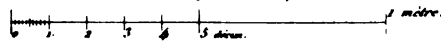
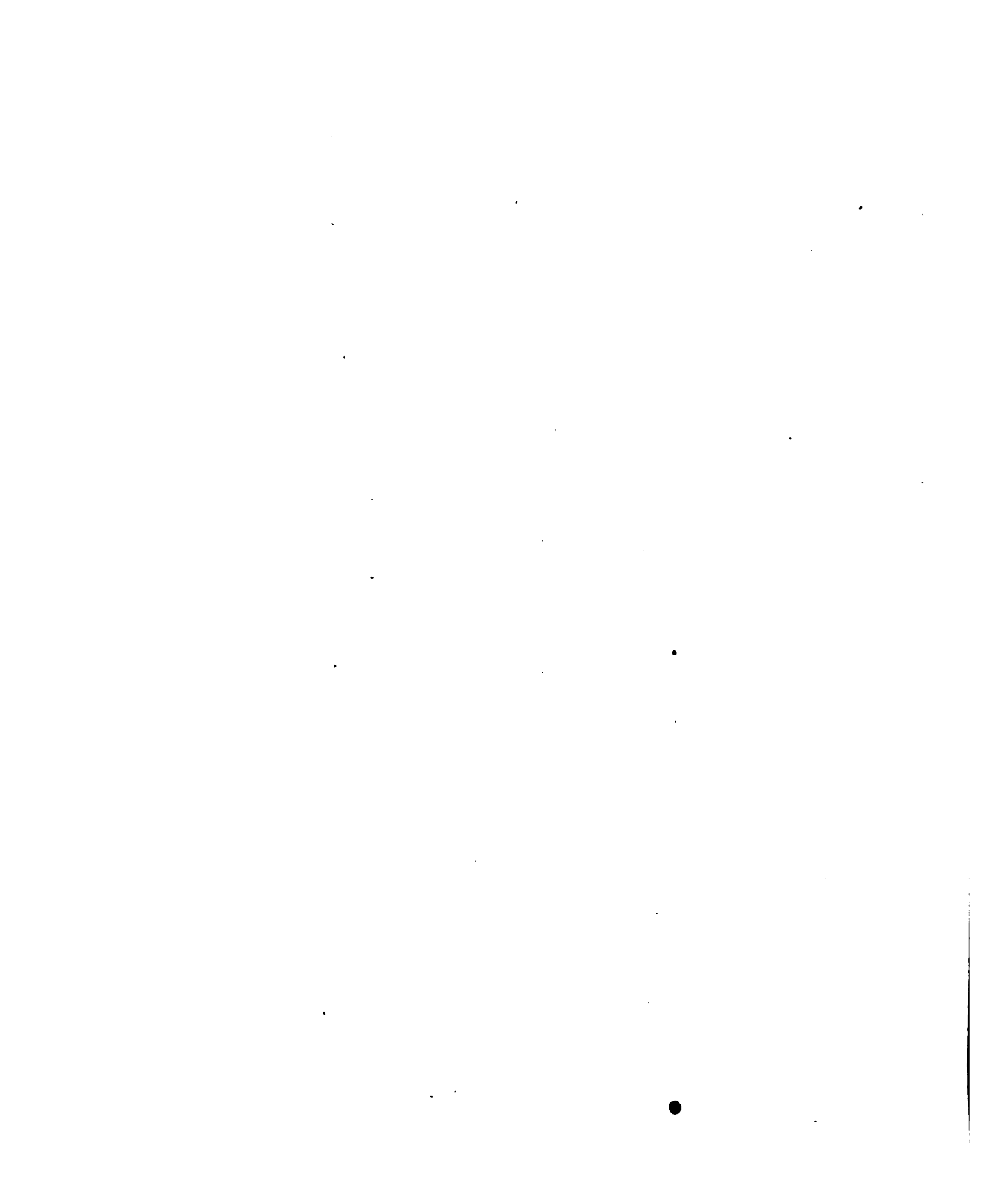


Fig. 8.



Echelle des Fig. 6, 7, 8 et 17.





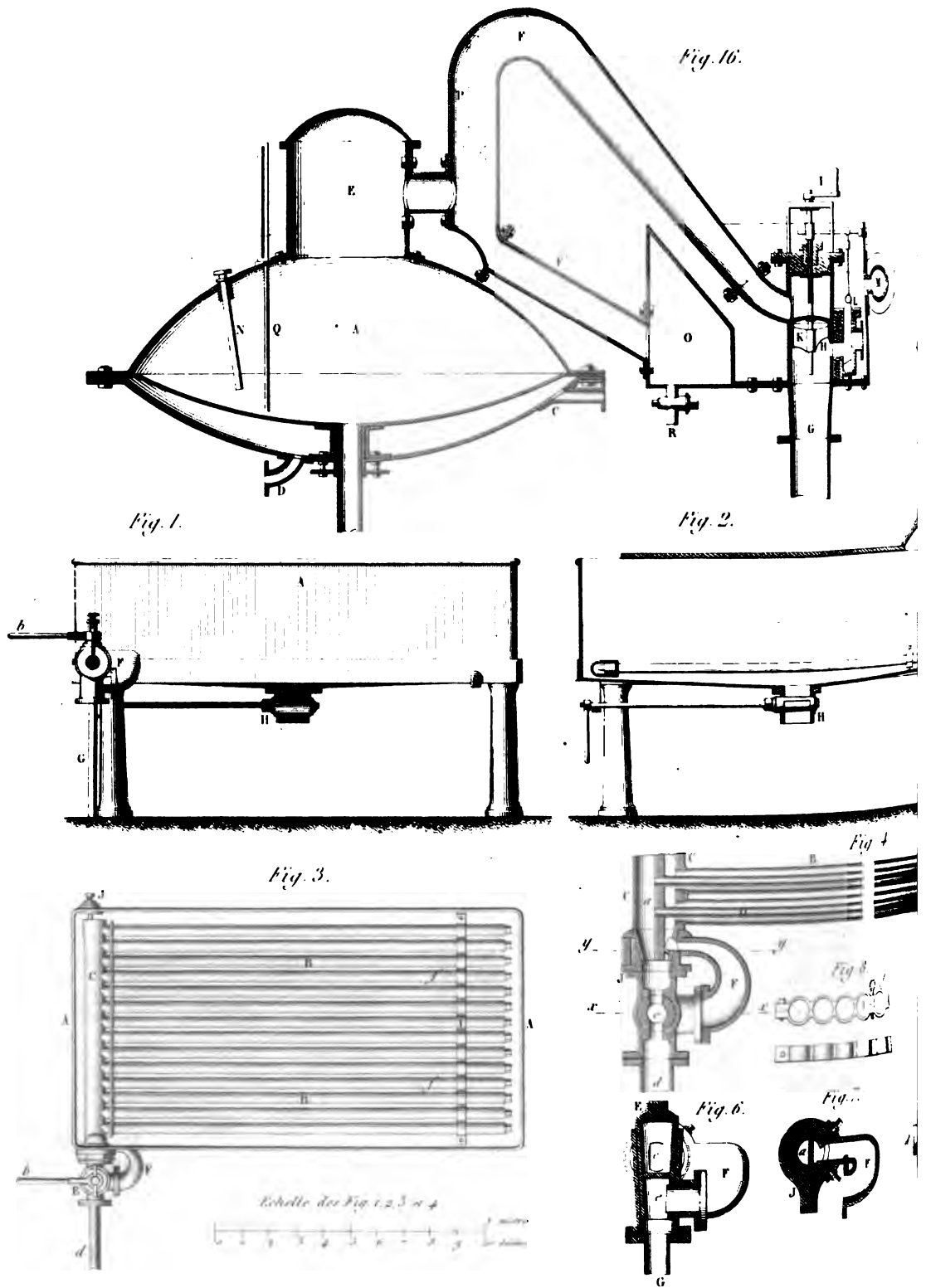


Fig. 9.

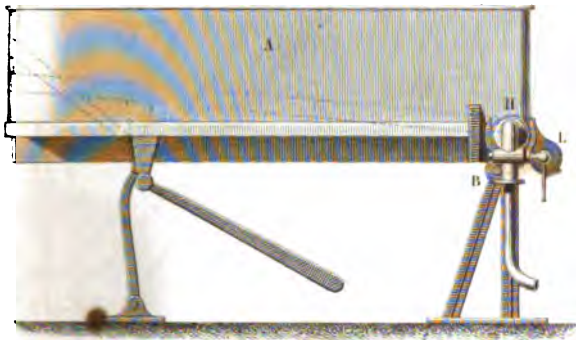


Fig. 10.

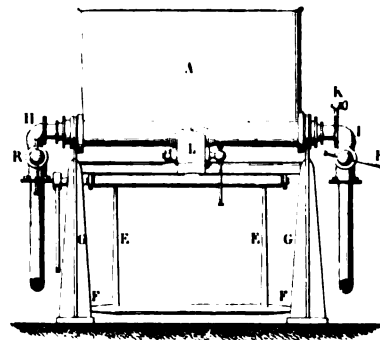


Fig. 12.

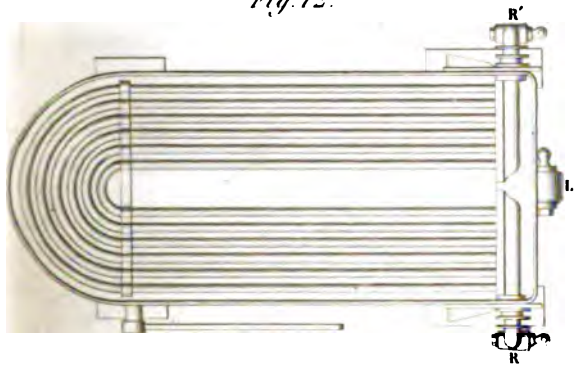
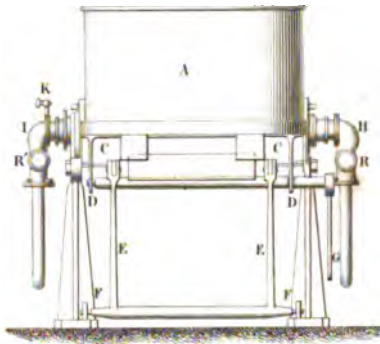


Fig. 11.



Echelle des Fig. 9, 10, 11 et 12.

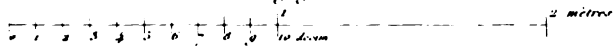


Fig. 15.

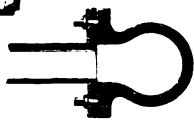


Fig. 13.

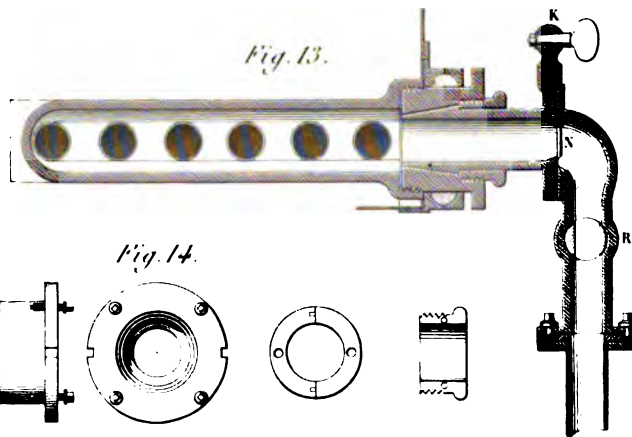


Fig. 5.

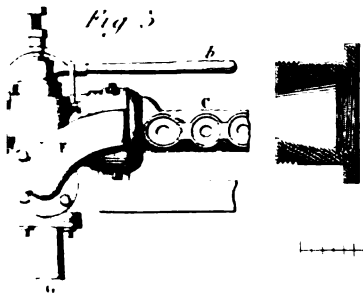
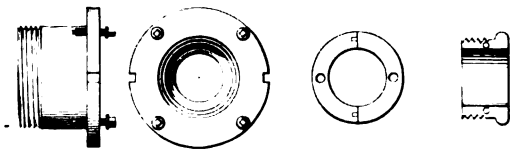
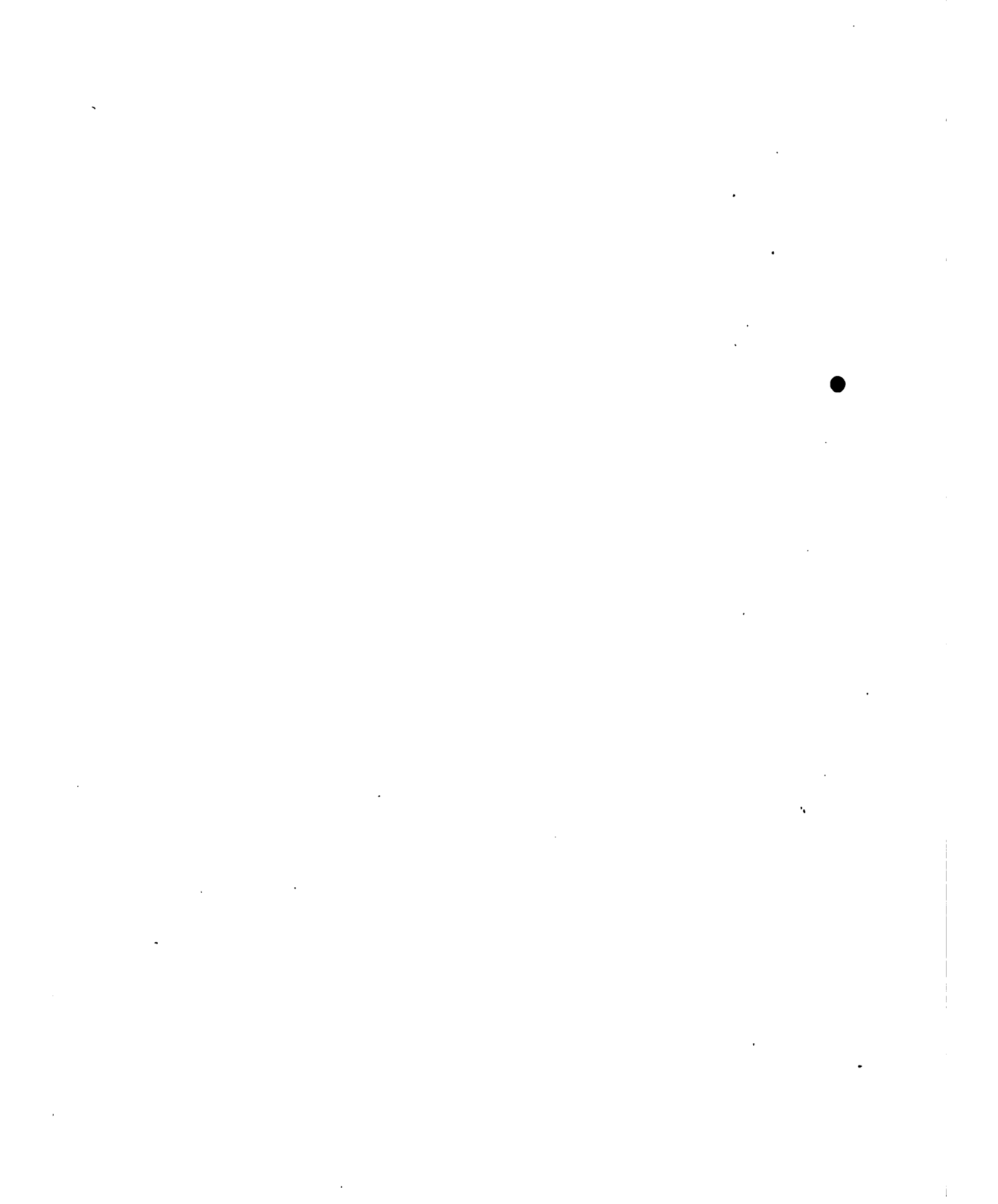


Fig. 14.



Echelle des Fig. 4, 5, 6, 7, 8, 13, 14 et 15.







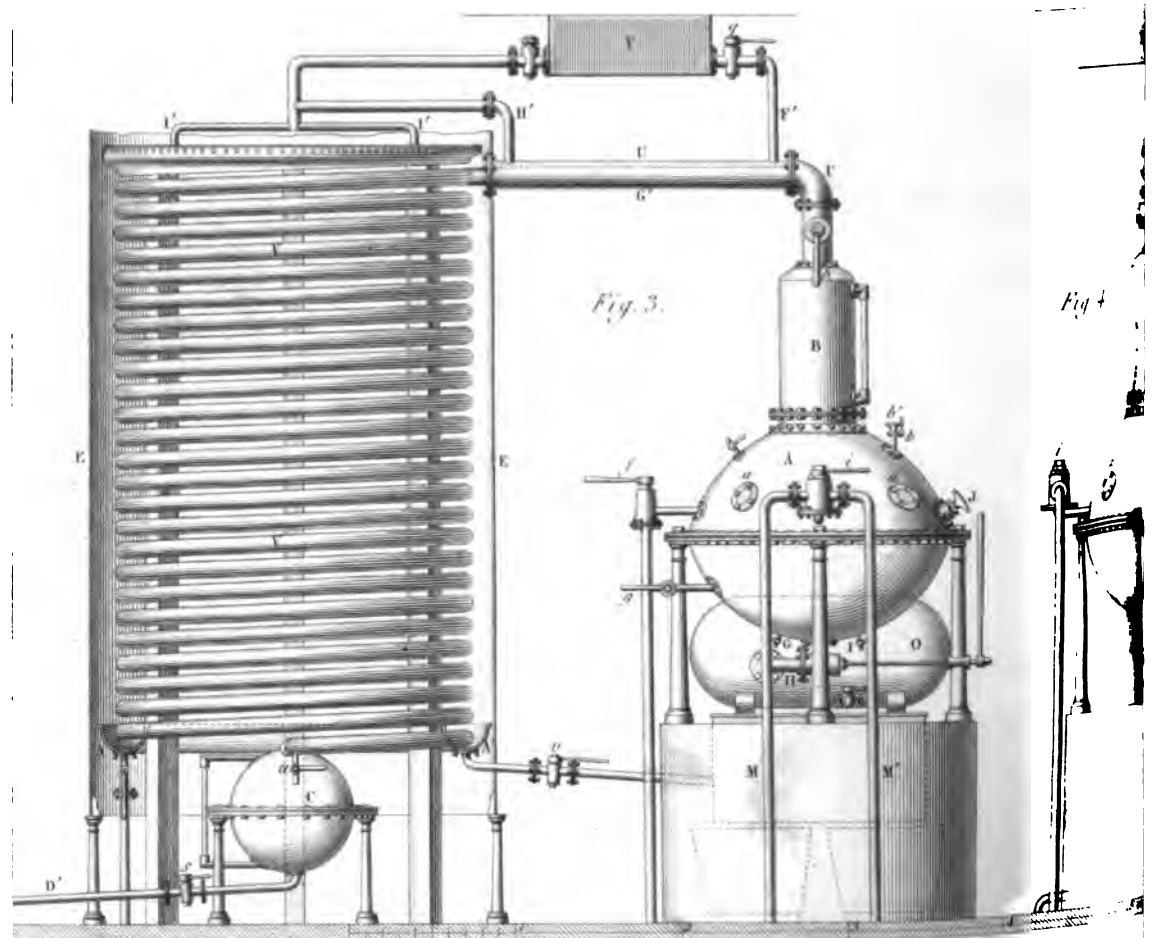
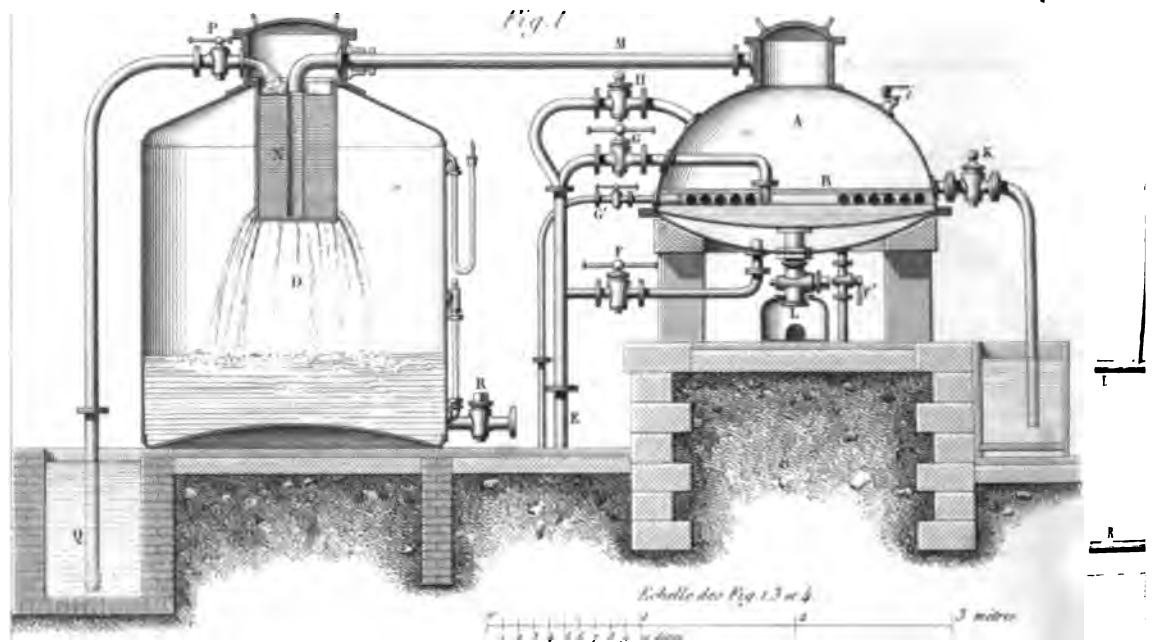
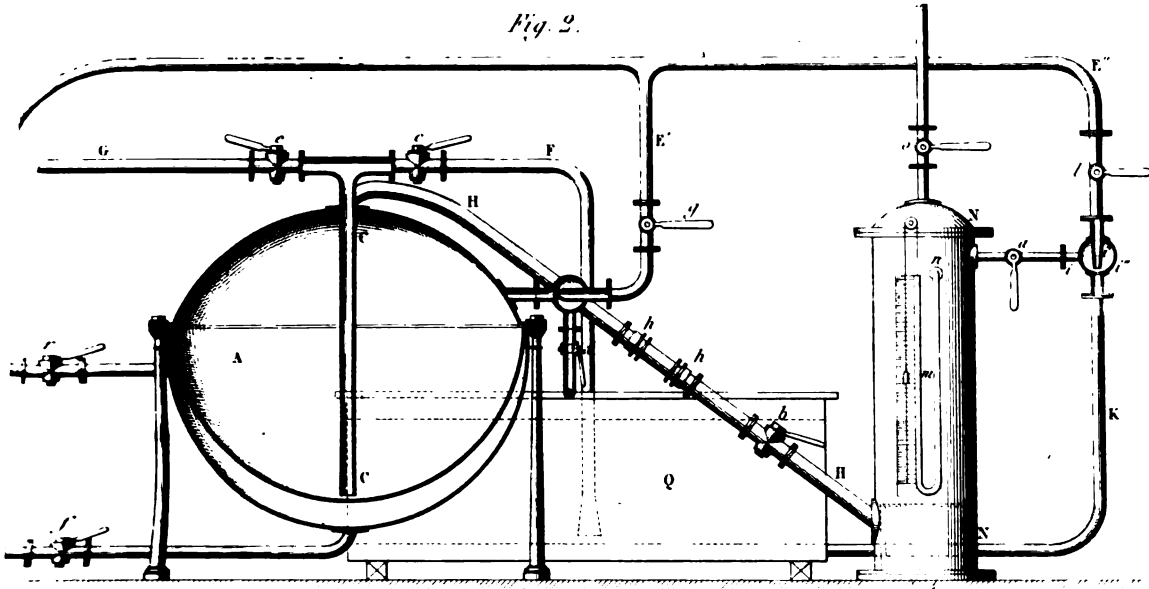


Fig. 2.



Echelle de la Fig. 2.

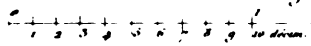


Fig. 5.

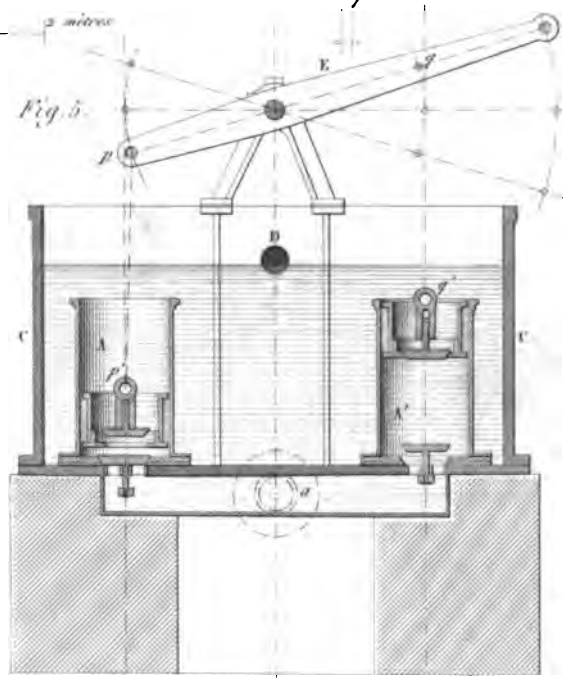
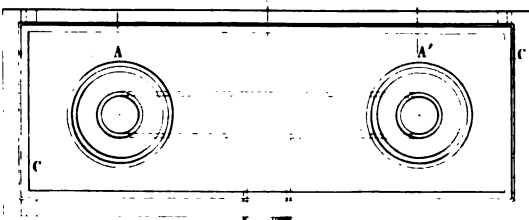


Fig. 6.



Echelle des Fig. 5 et 6.

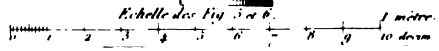
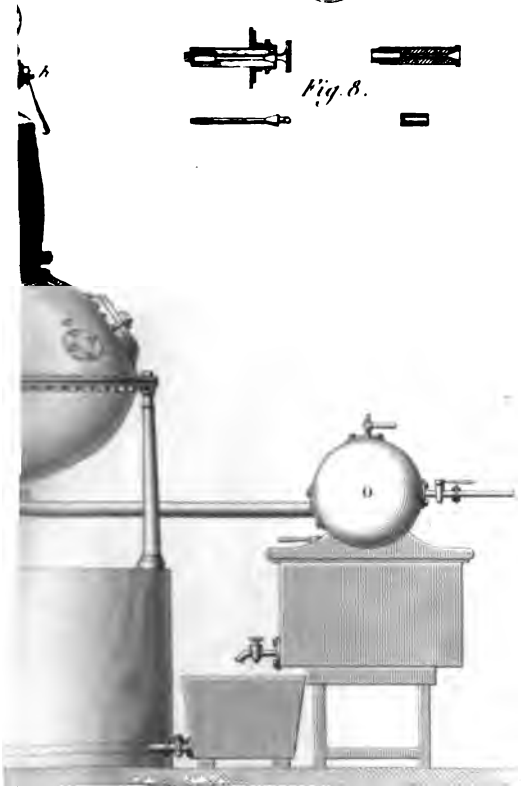
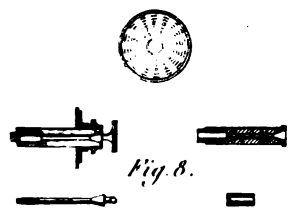
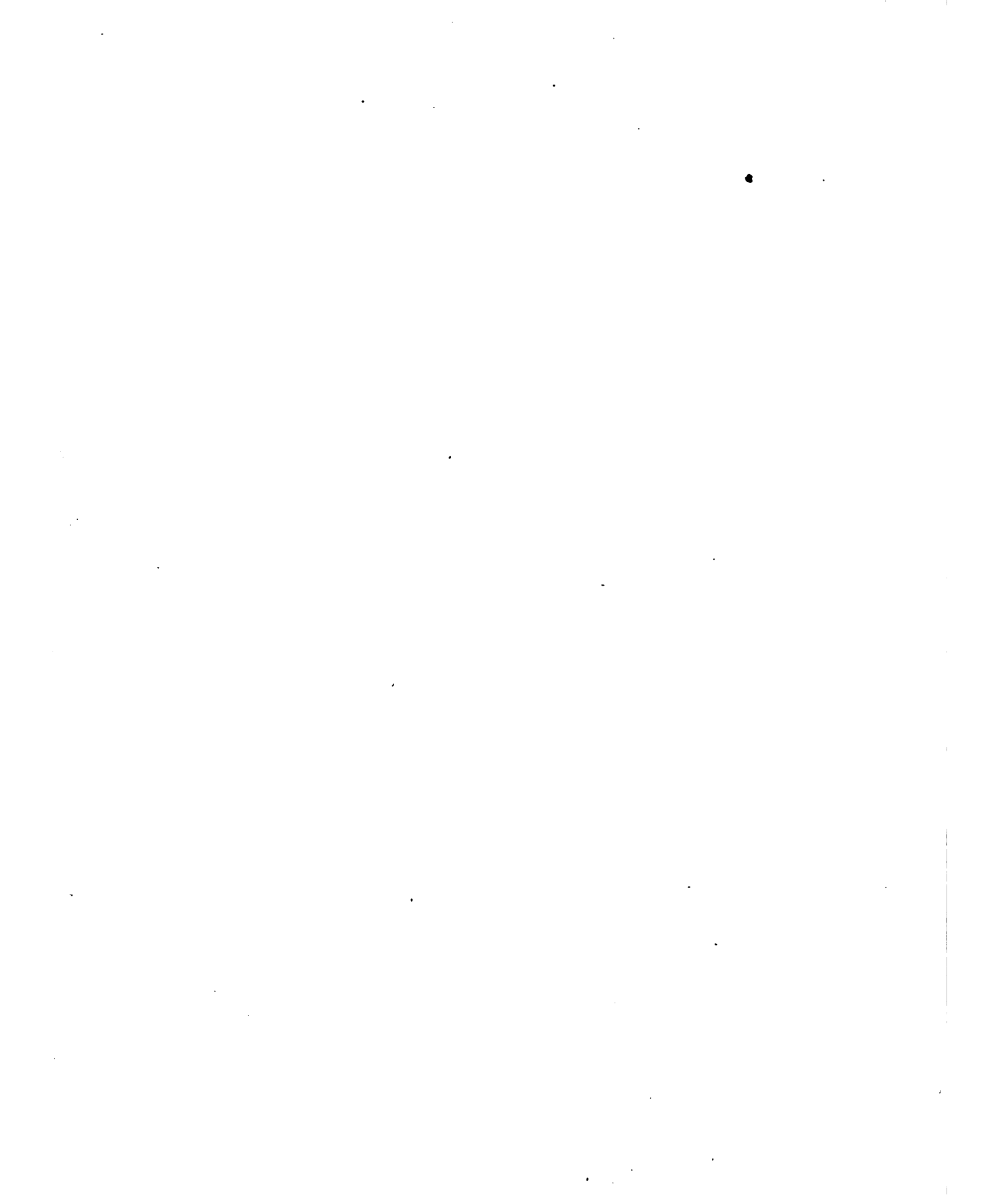


Fig. 8.



grave par Clouard.



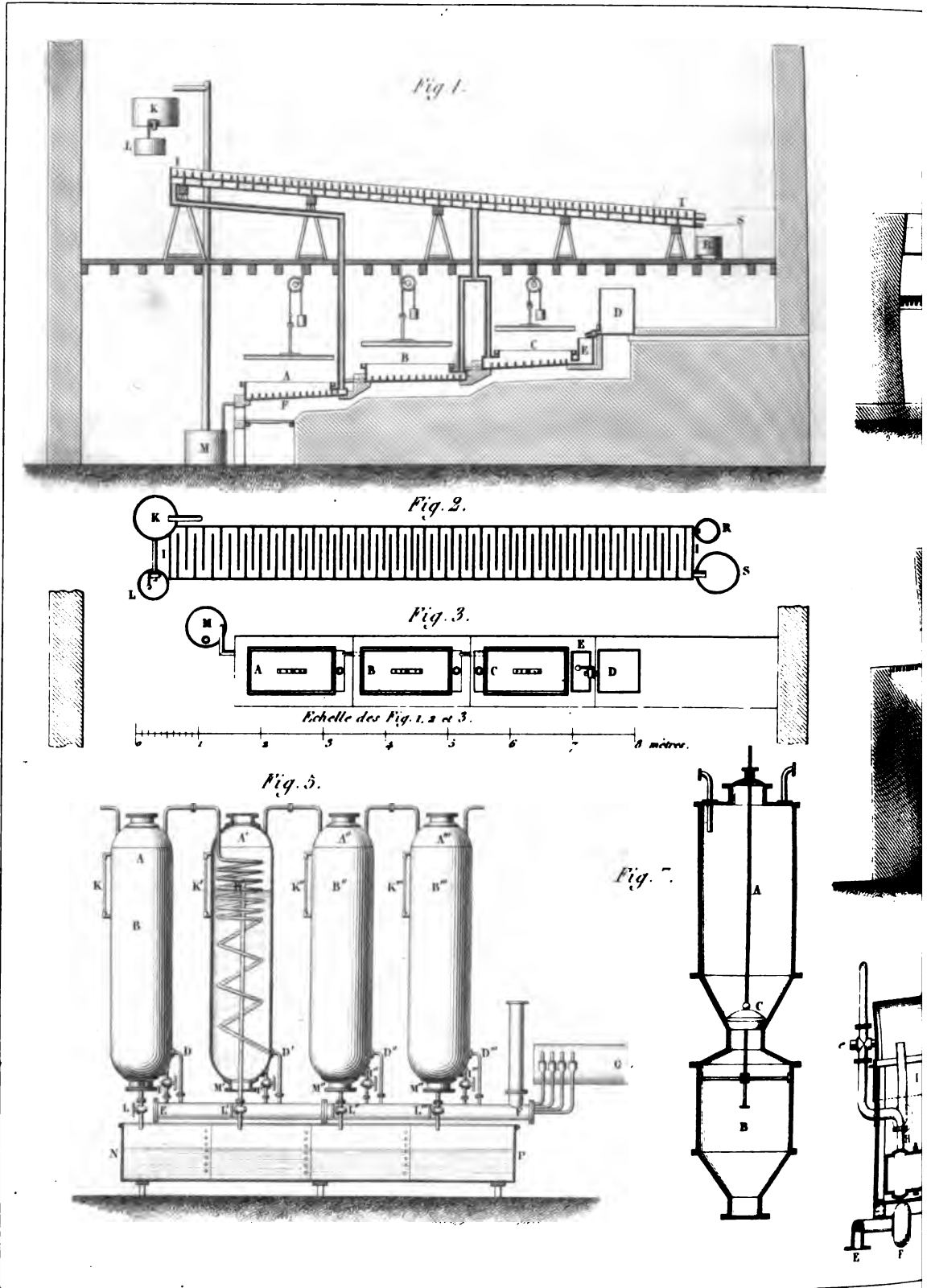


Fig. 4.

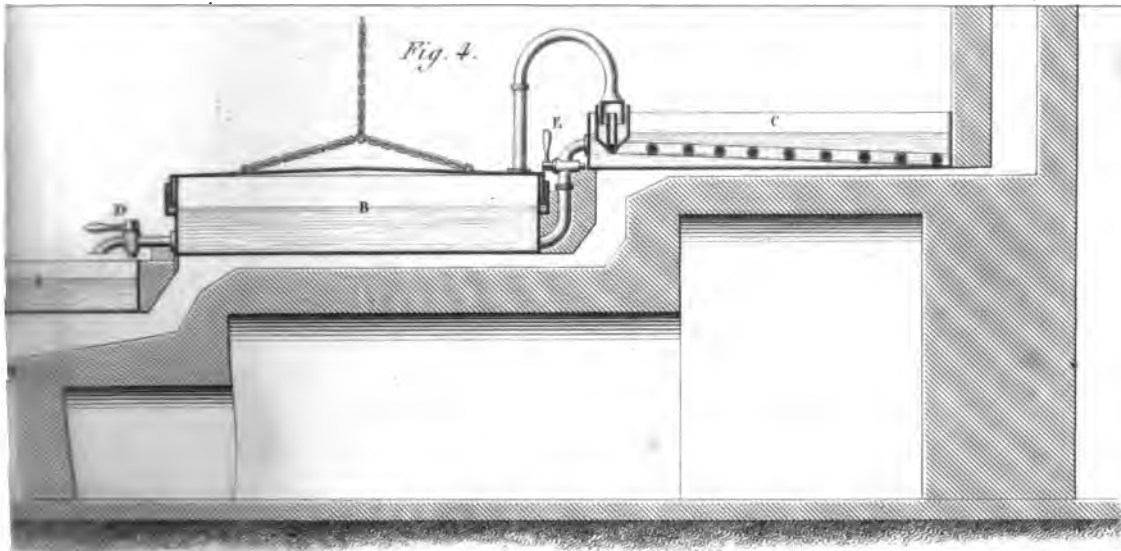


Fig. 6.

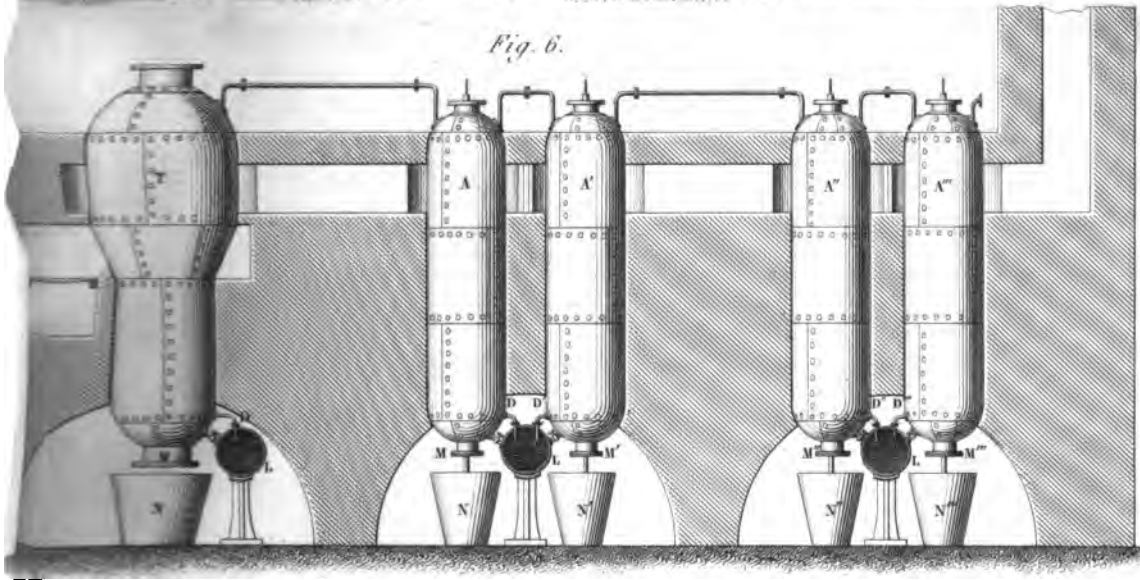


Fig. 8.

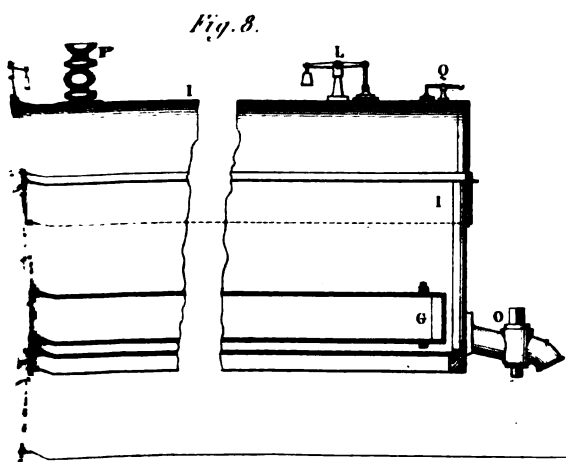
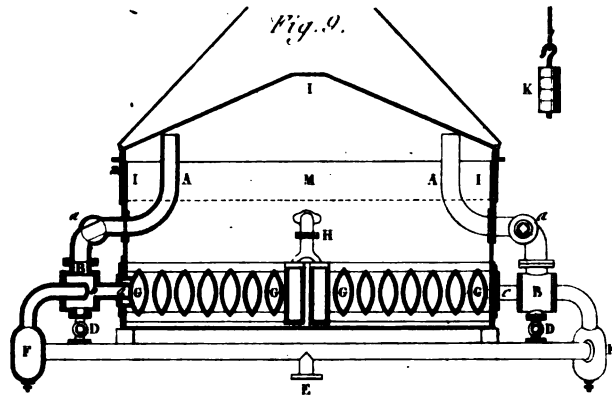
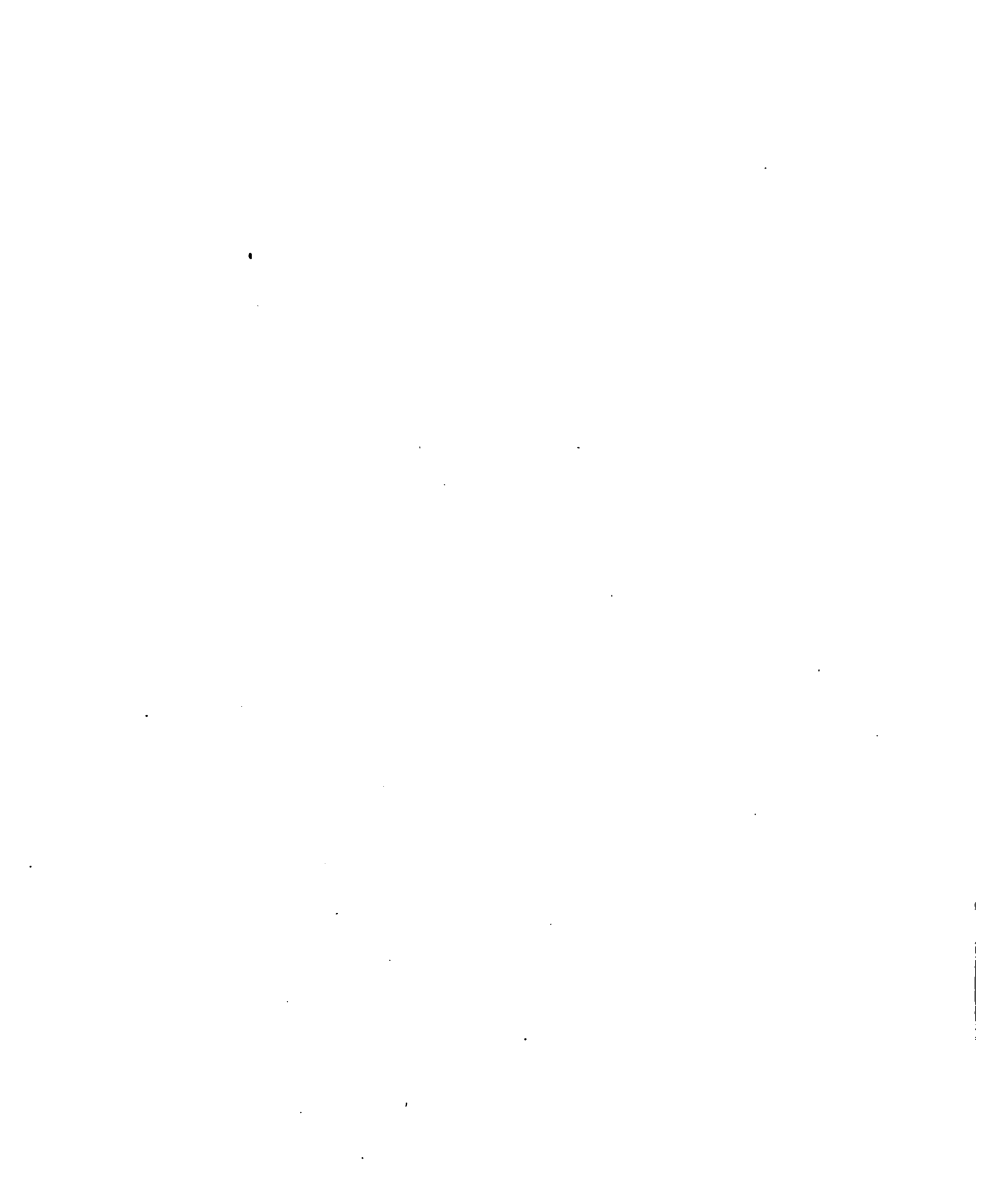


Fig. 9.





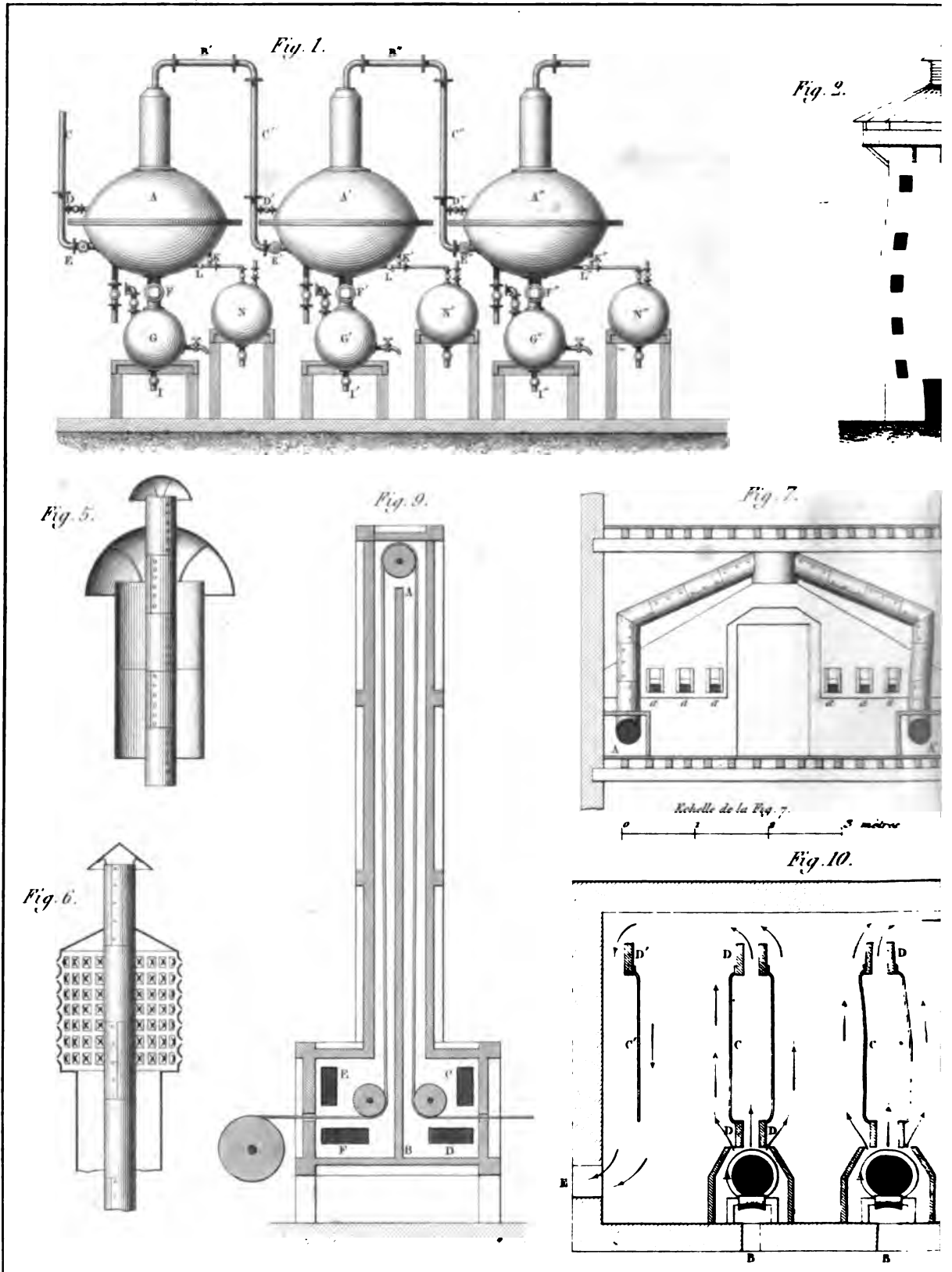


Fig. 3.

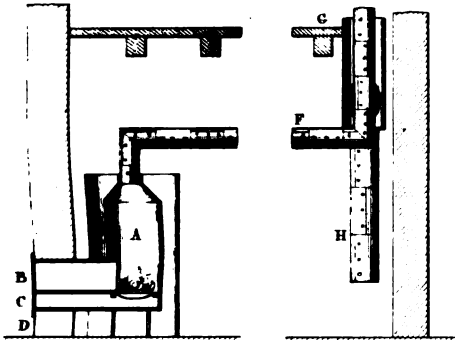


Fig. 4.

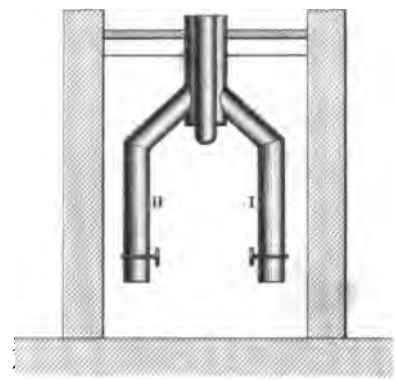


Fig. 8.

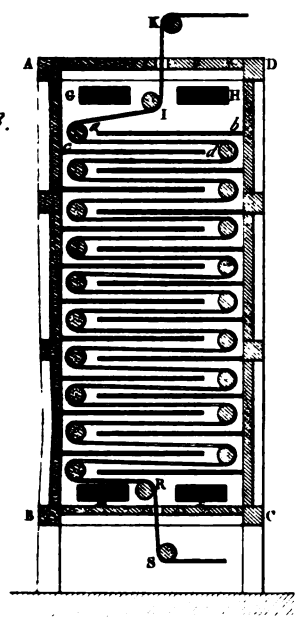


Fig. 12.

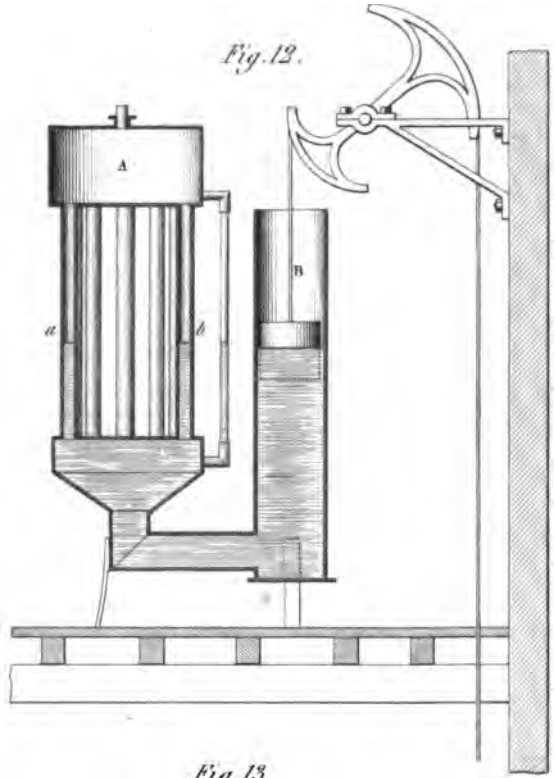


Fig. 11.

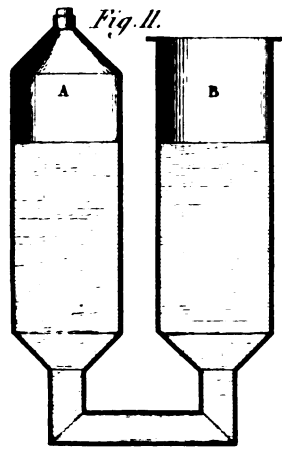
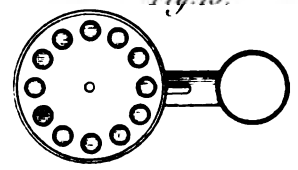
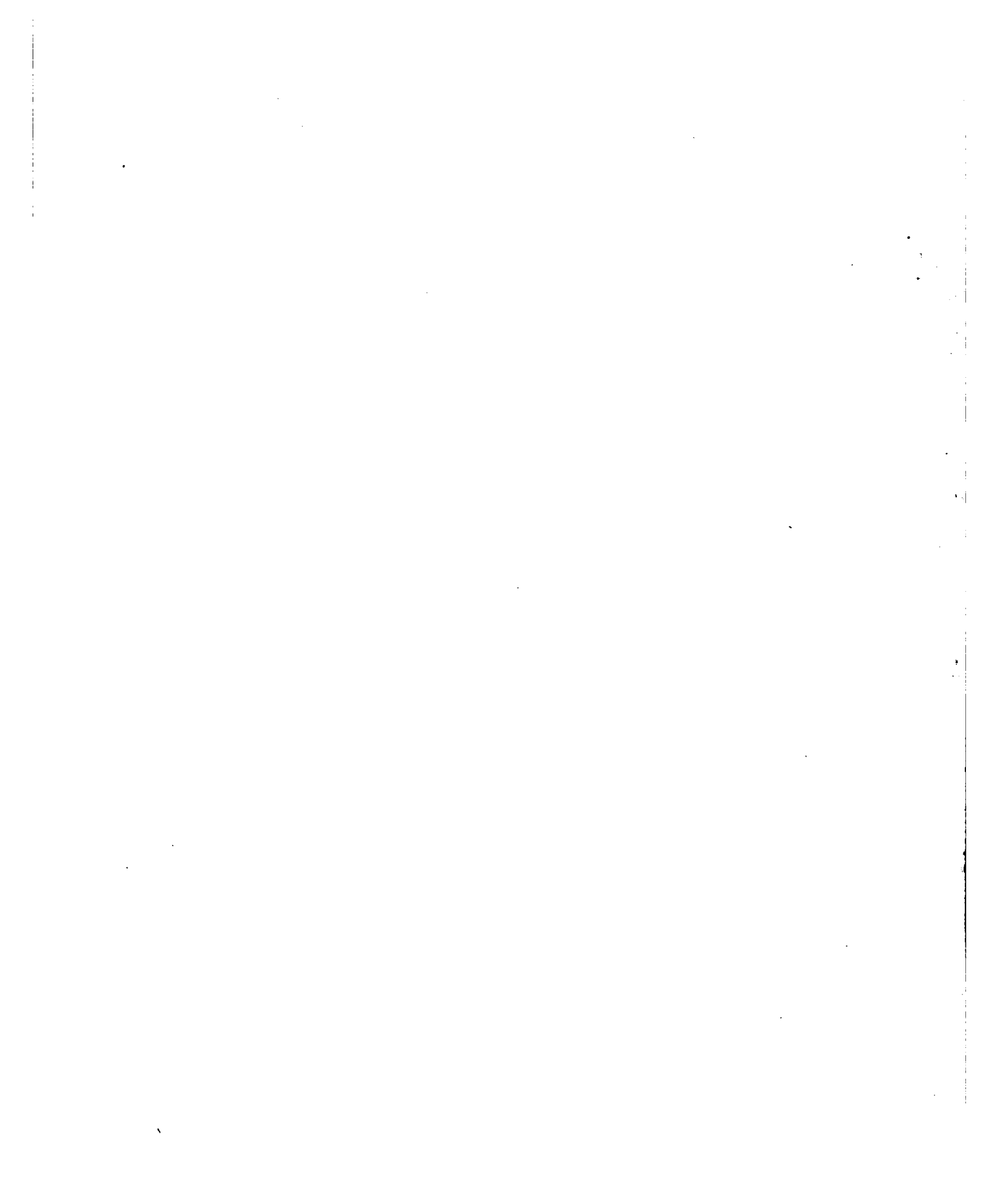
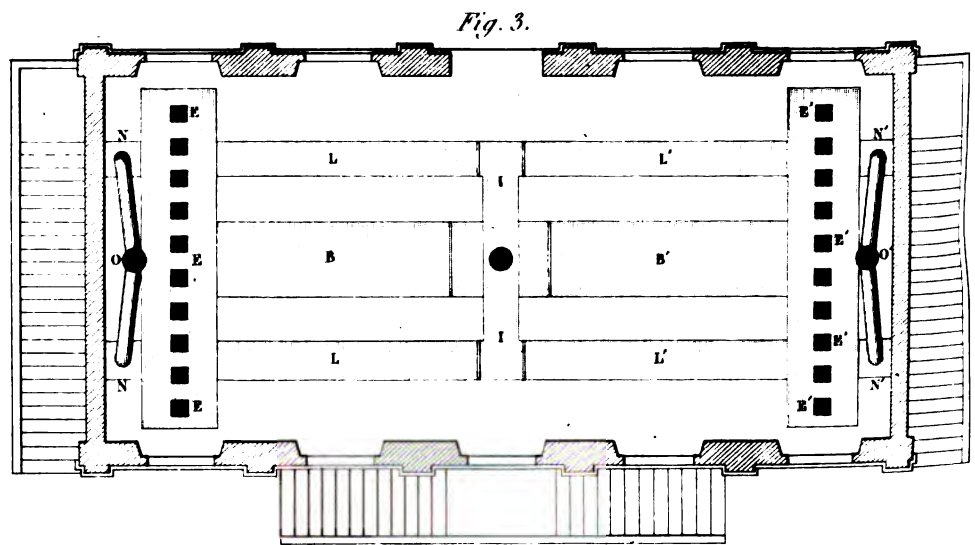
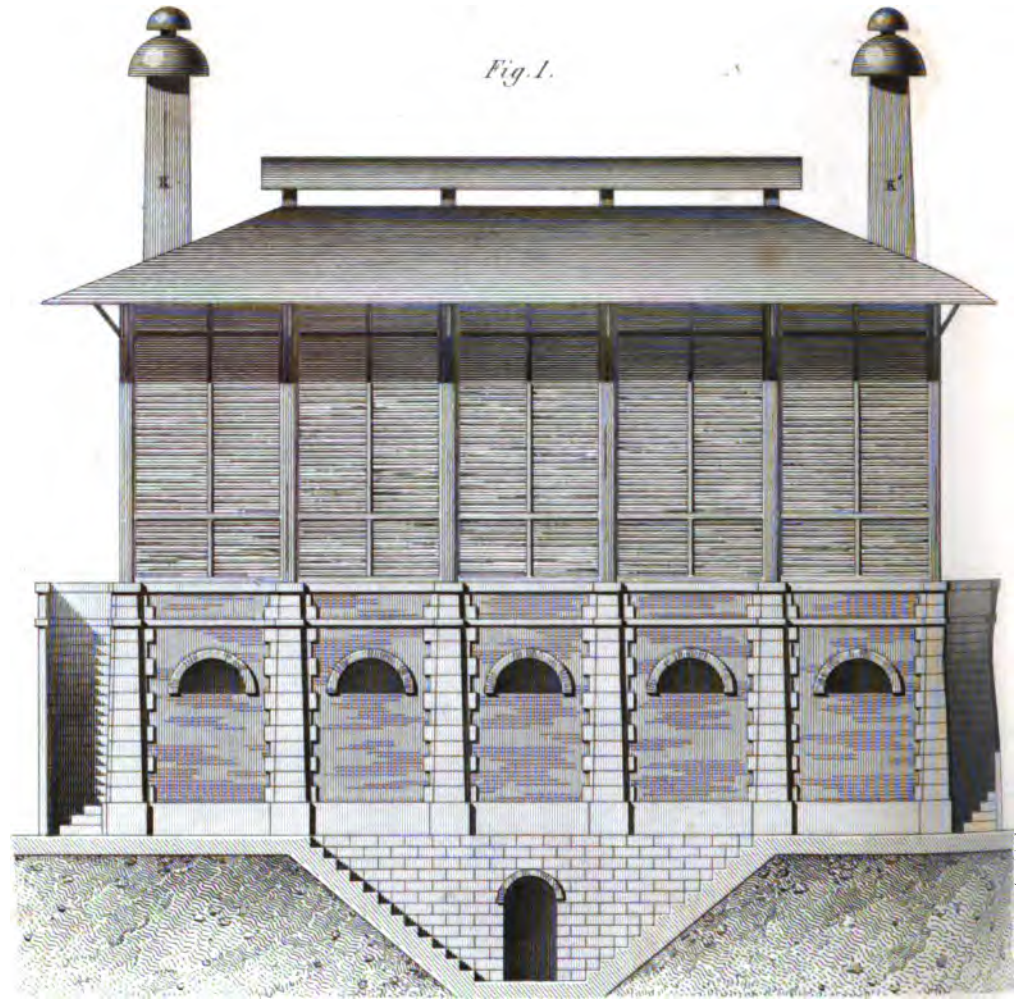


Fig. 13.







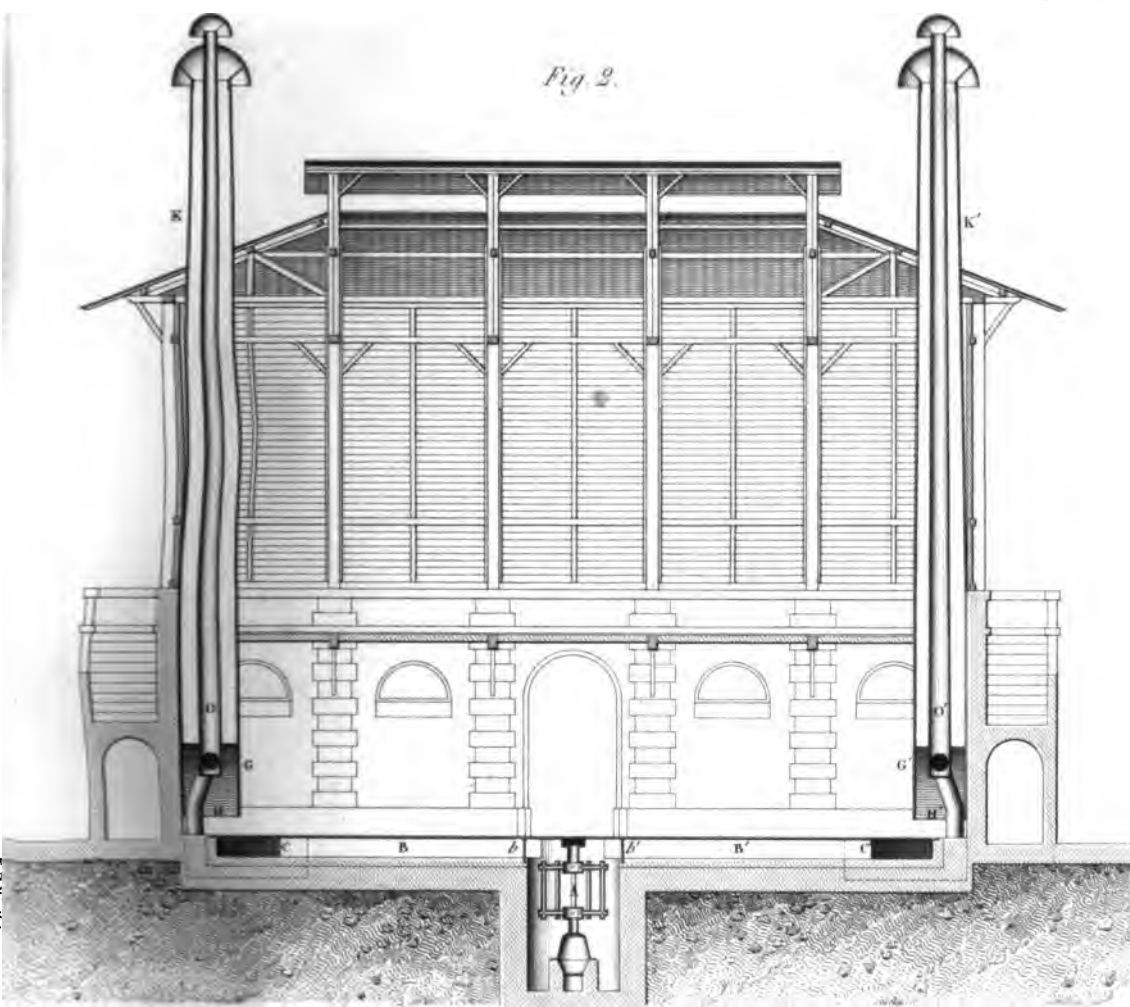
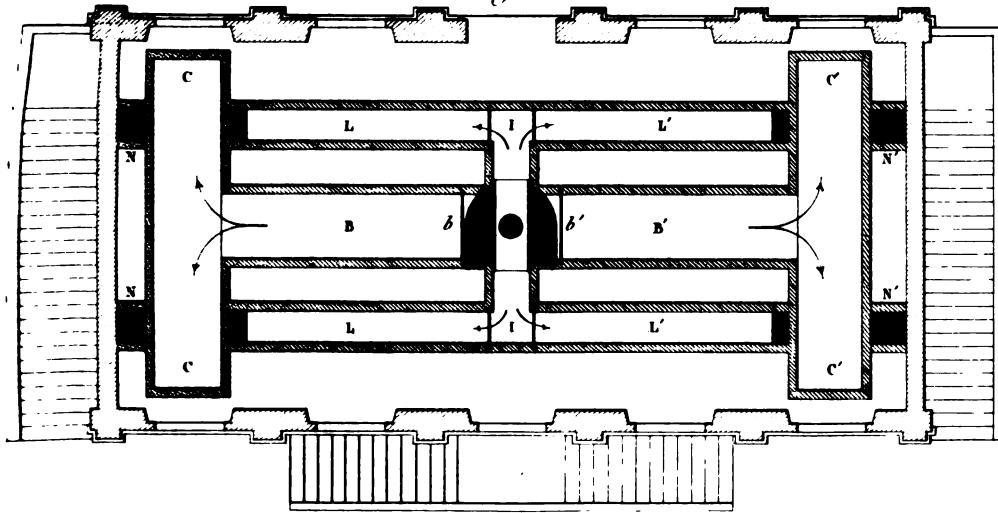


Fig. 4.



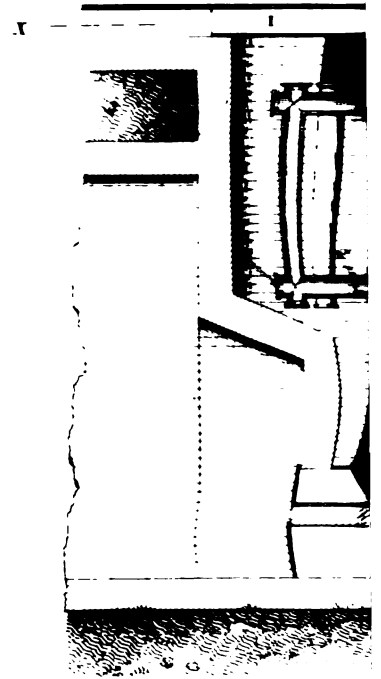
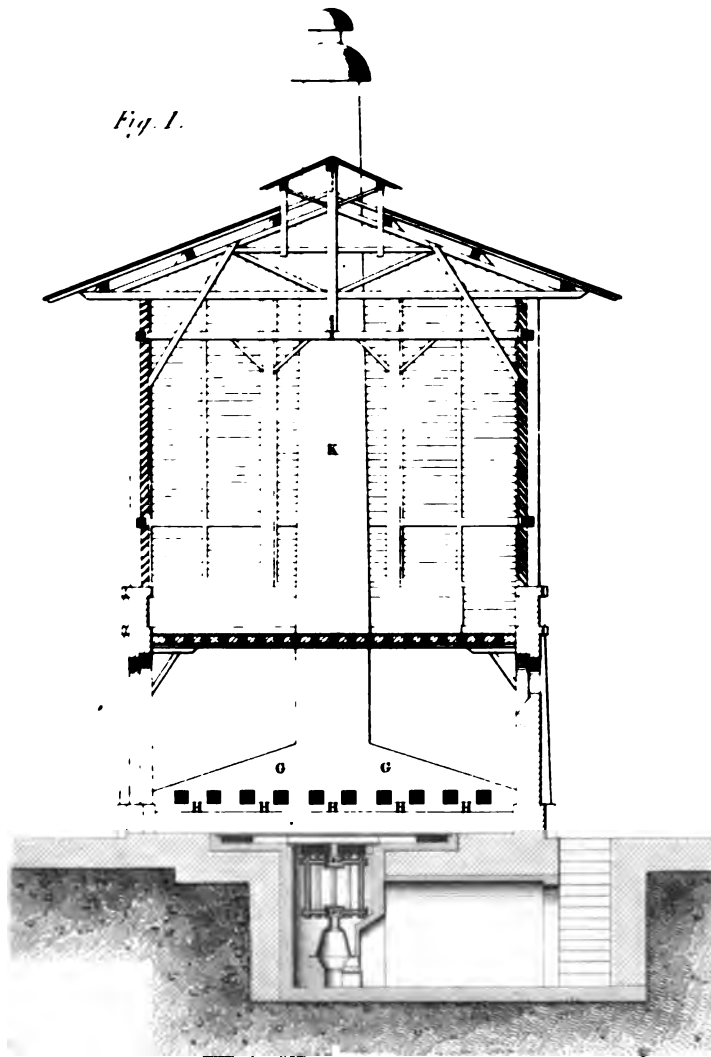


Fig. 4

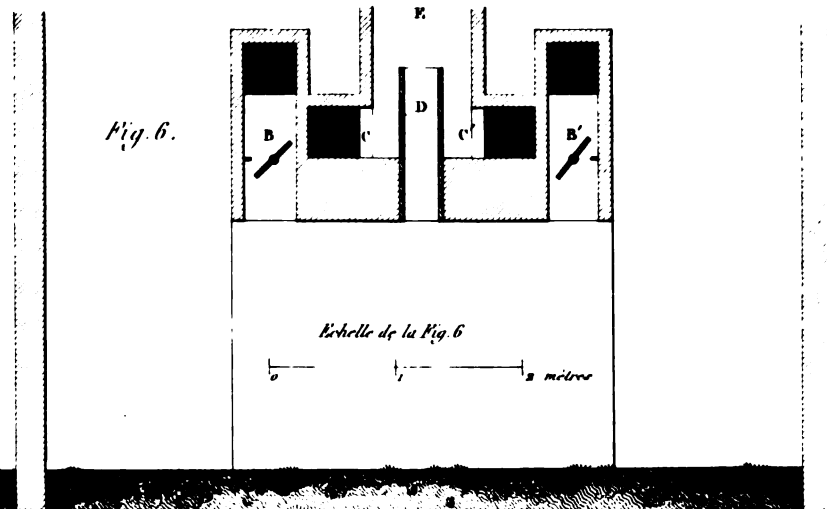
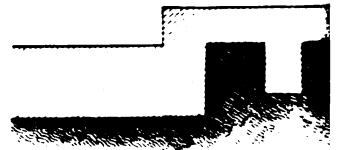
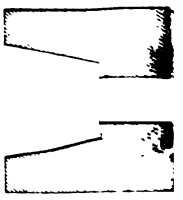
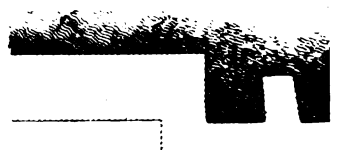


Fig. 2.

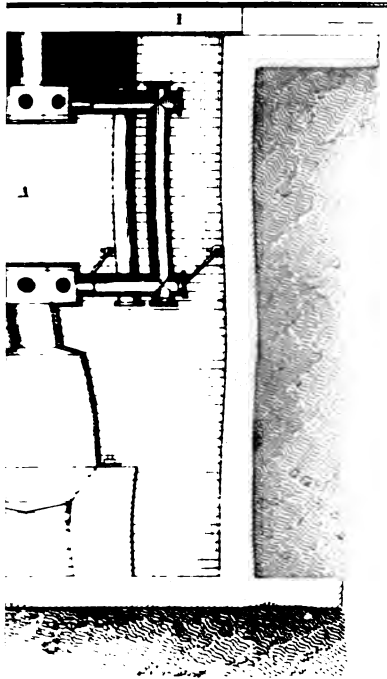


Fig. 3.

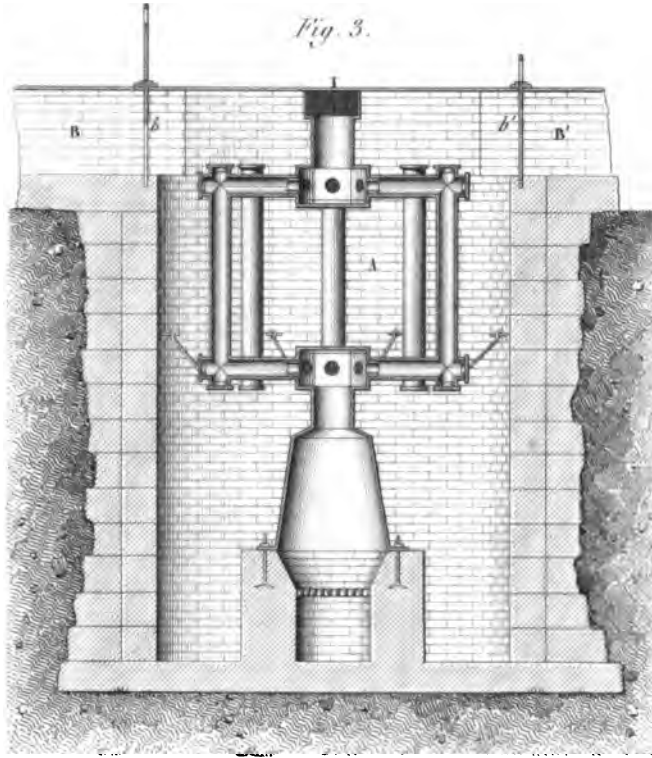
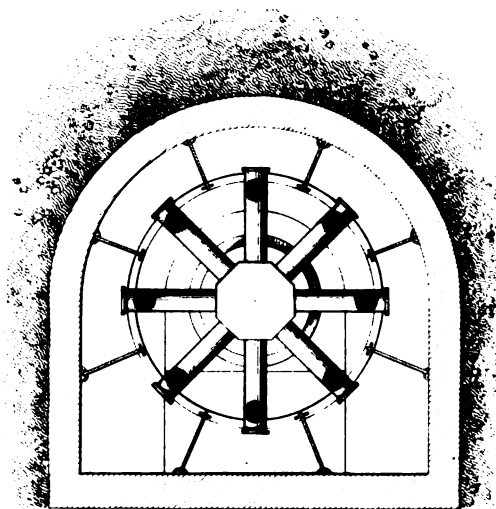
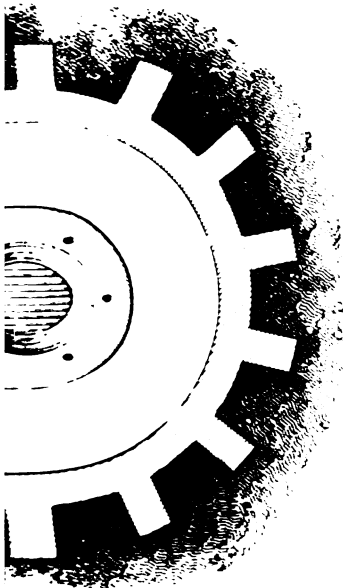
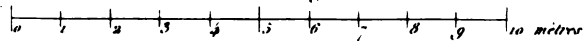


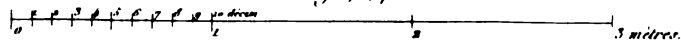
Fig. 5.

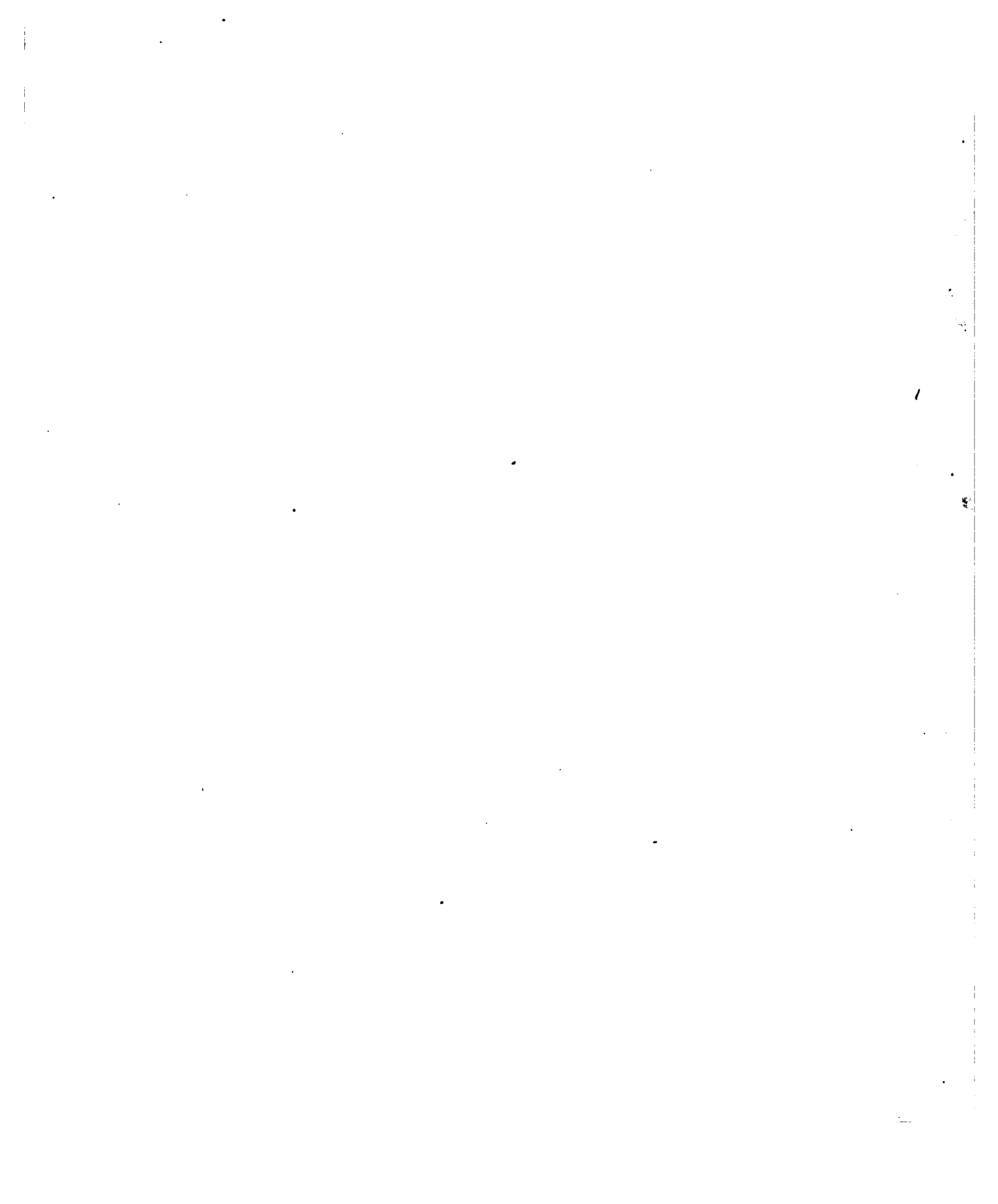


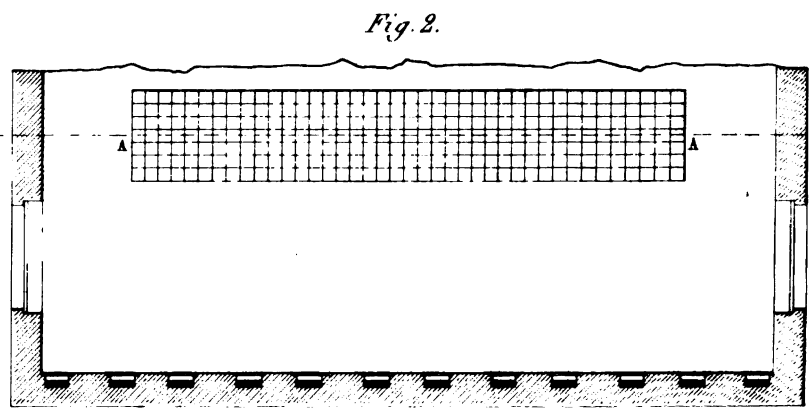
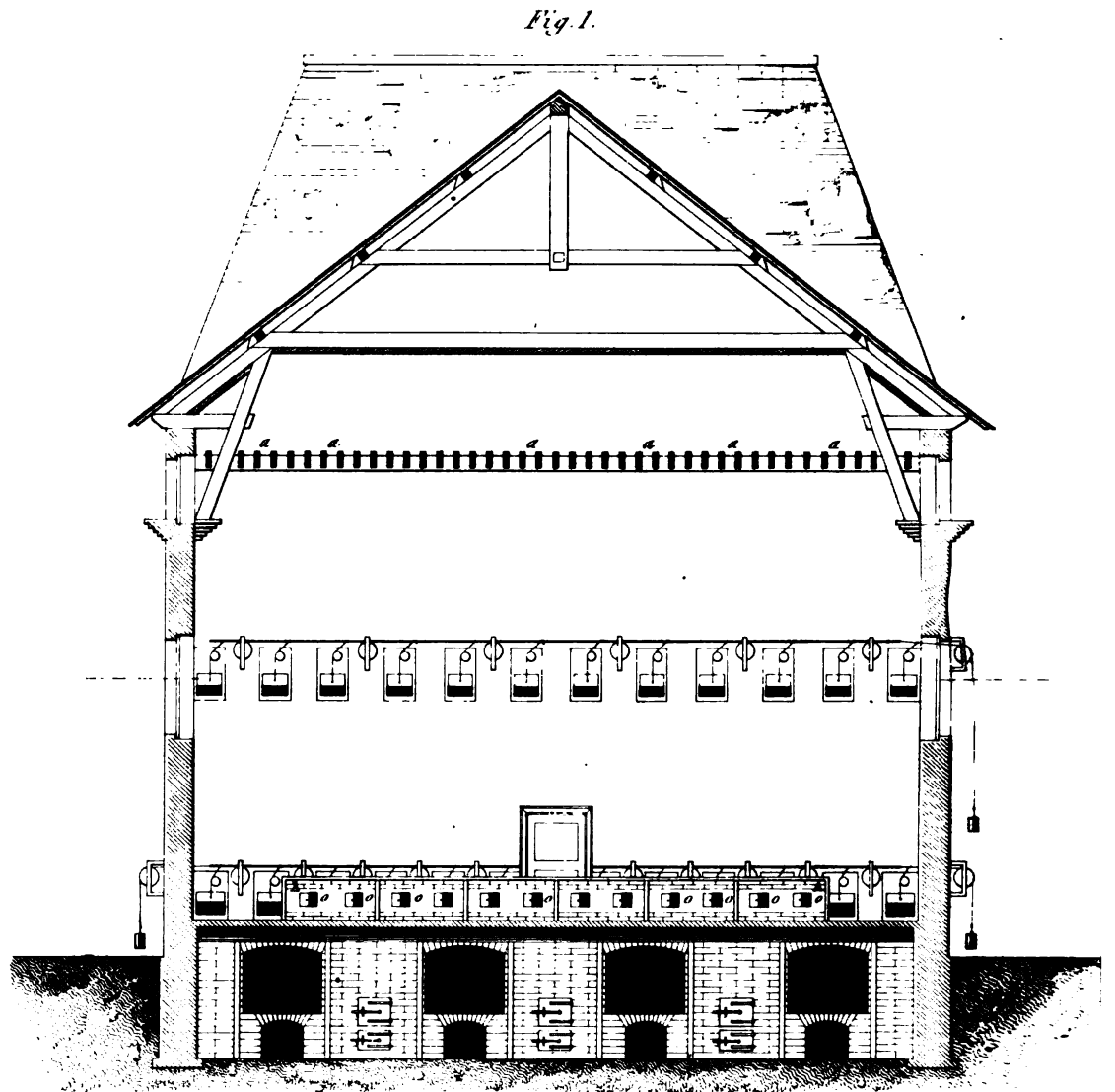
Echelle de la Fig. 1.



Echelle des Fig. 2, 3, 4 et 5.







Echelle des Fig. 1 et 2.

0 1 2 3 4 5 6 7 8 9 10 mètres

Fig. 3.

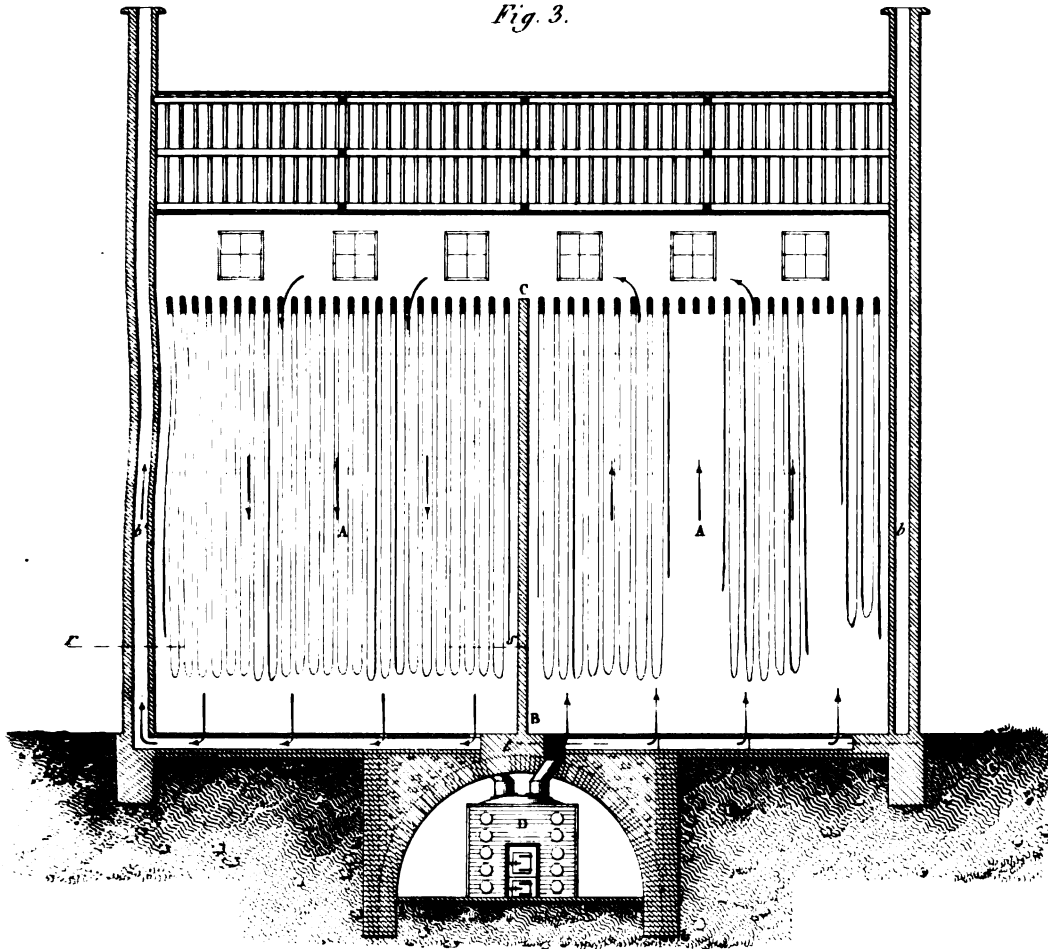
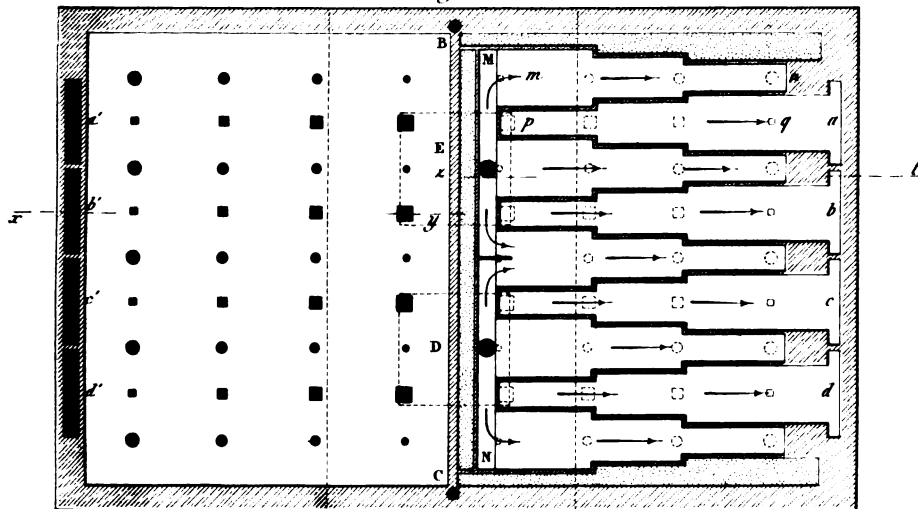
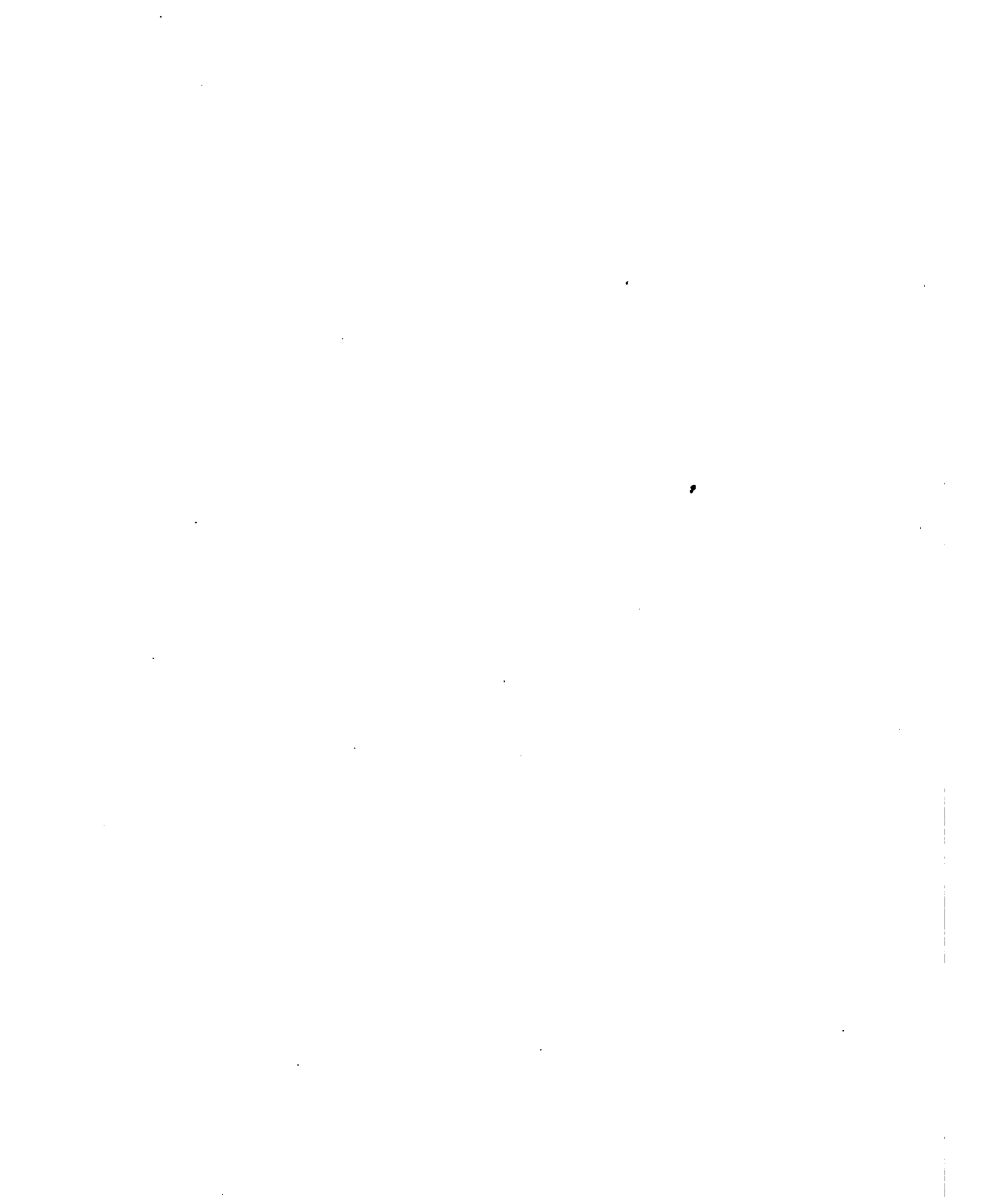


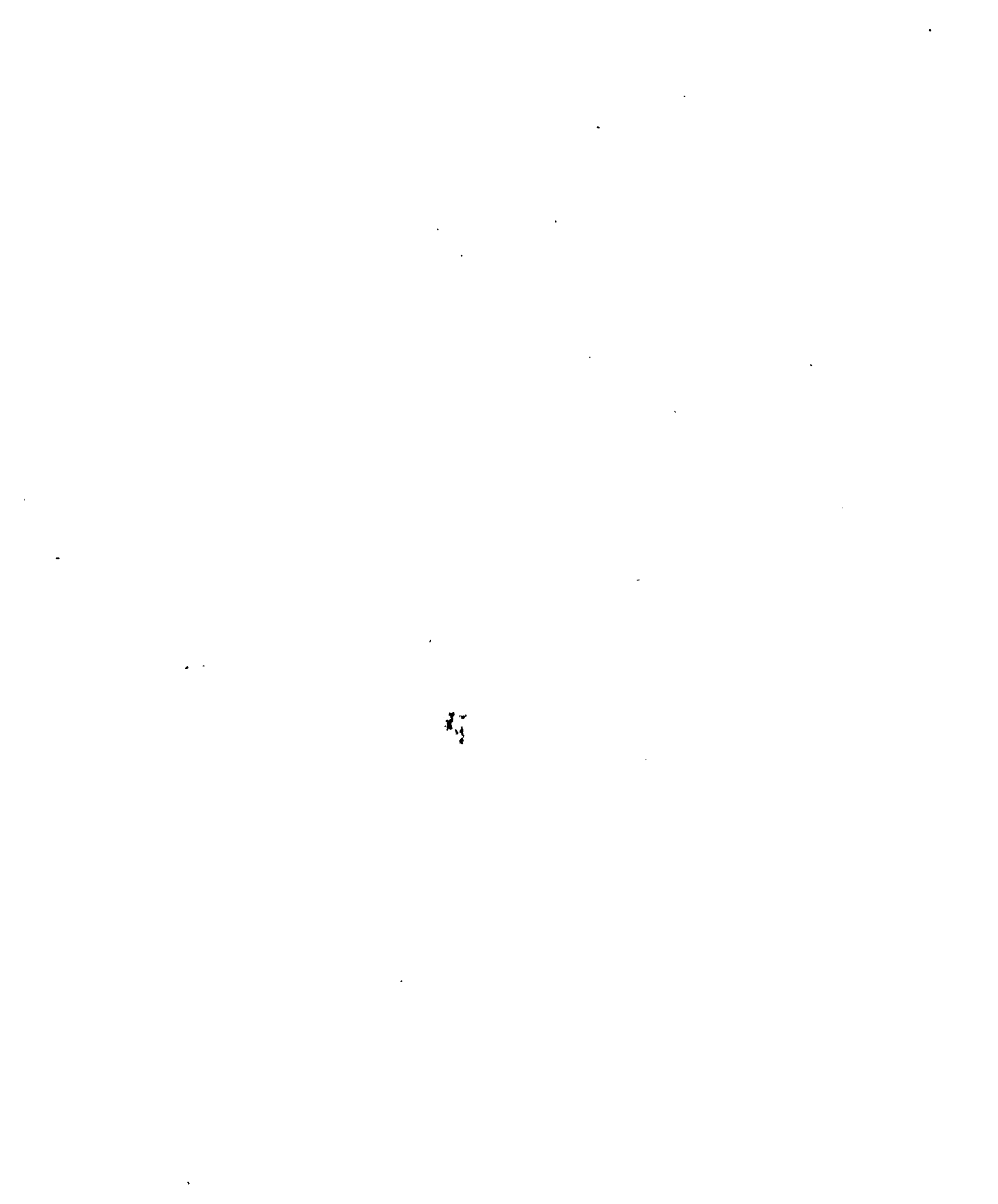
Fig. 4.

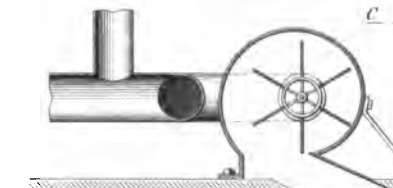
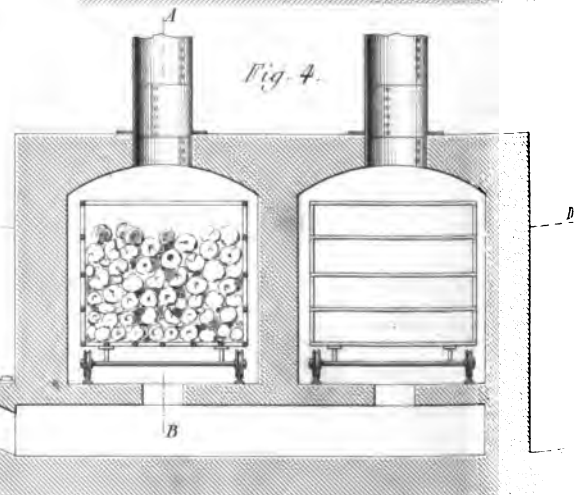
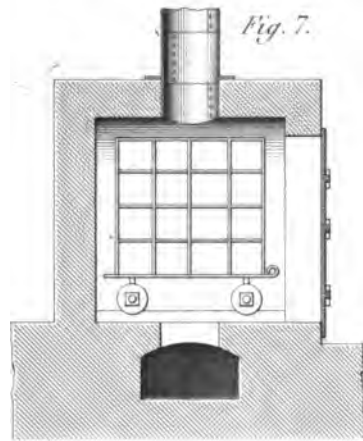
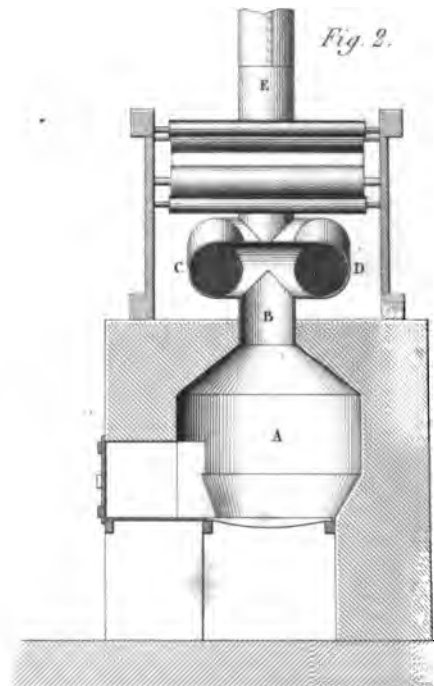
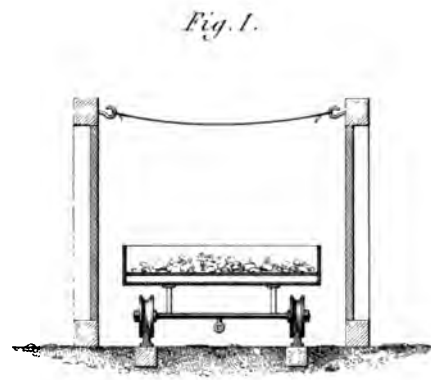


Echelle des Fig. 3 et 4.

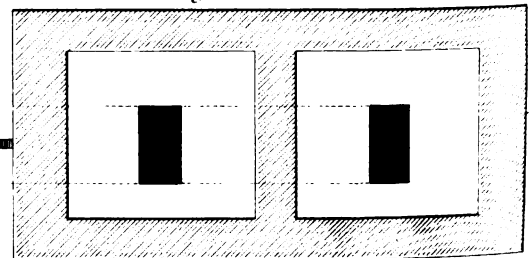
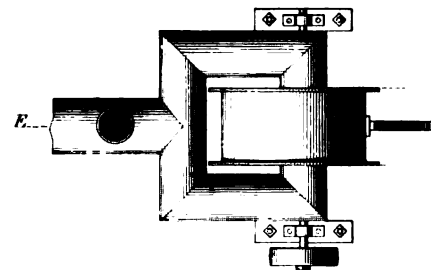
0 1 2 3 4 5 6 7 8 9 10 mètres.

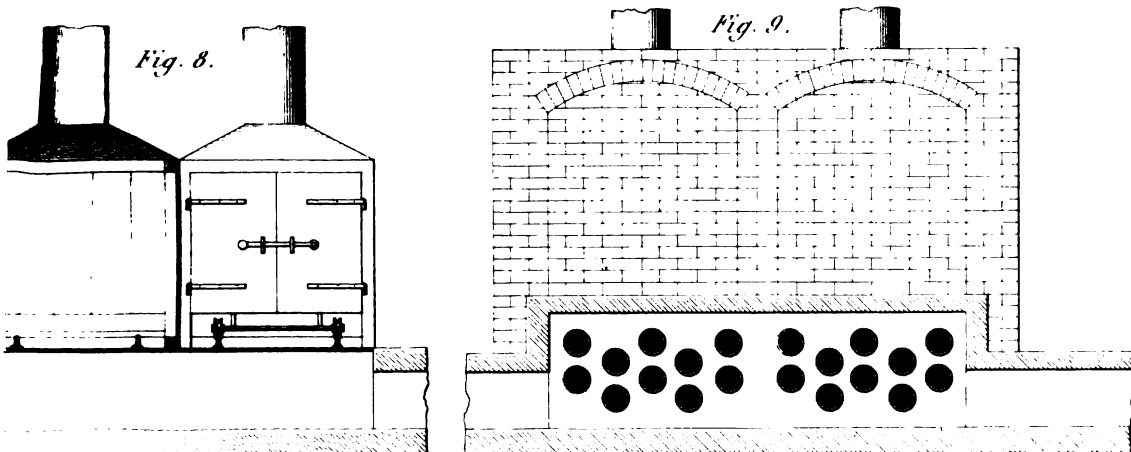
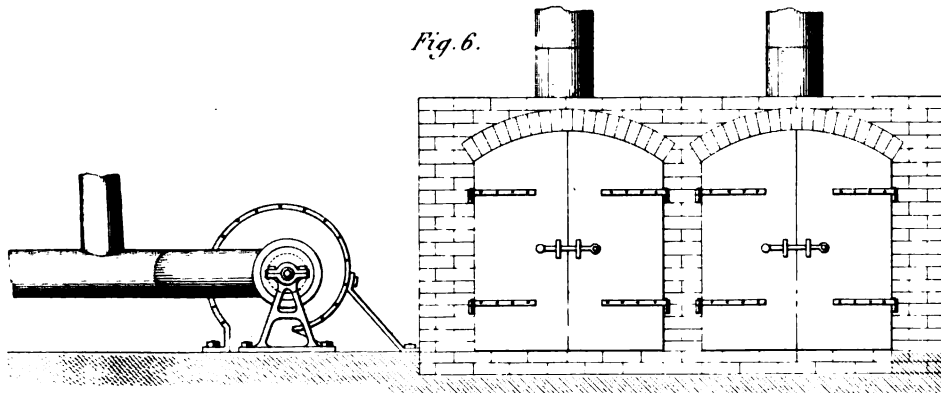
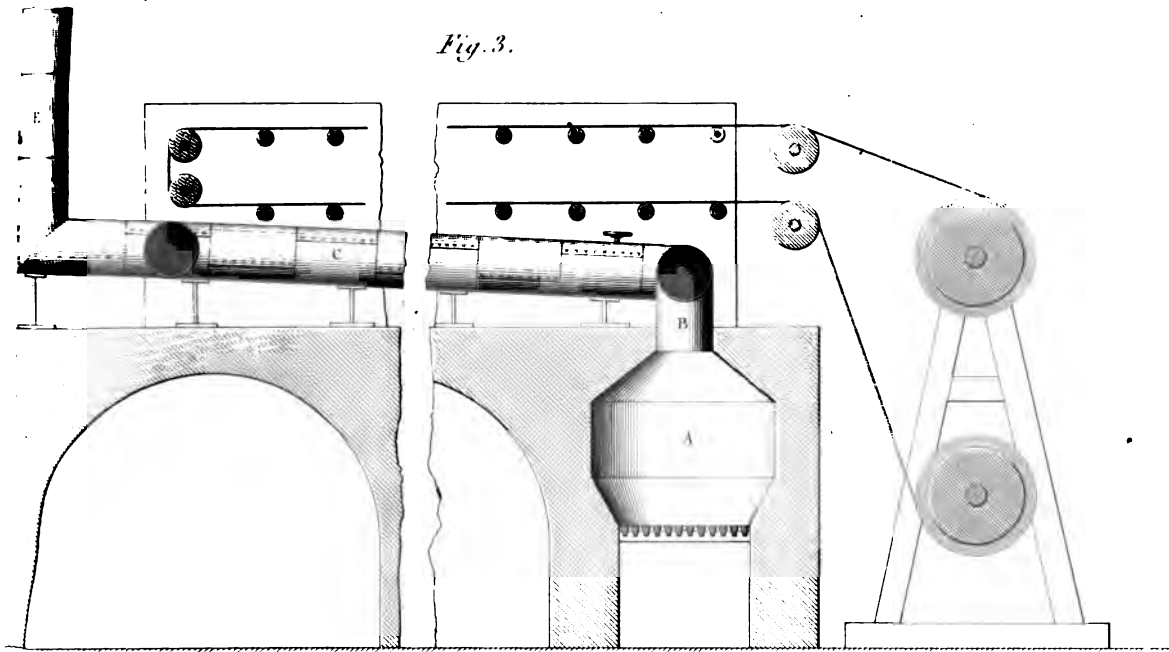


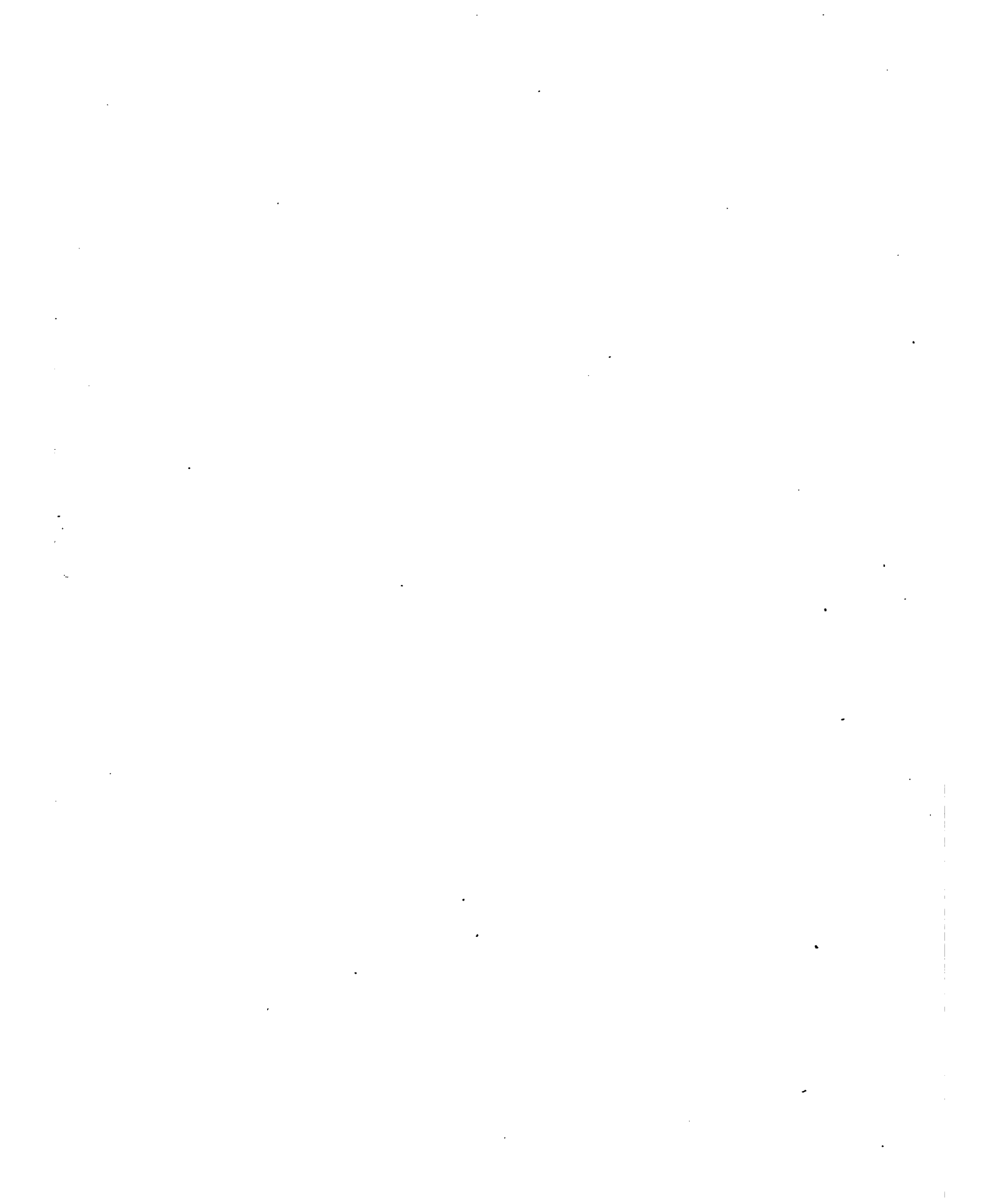




Echelle des Fig 4, 5, 6, 7, 8 u. 9







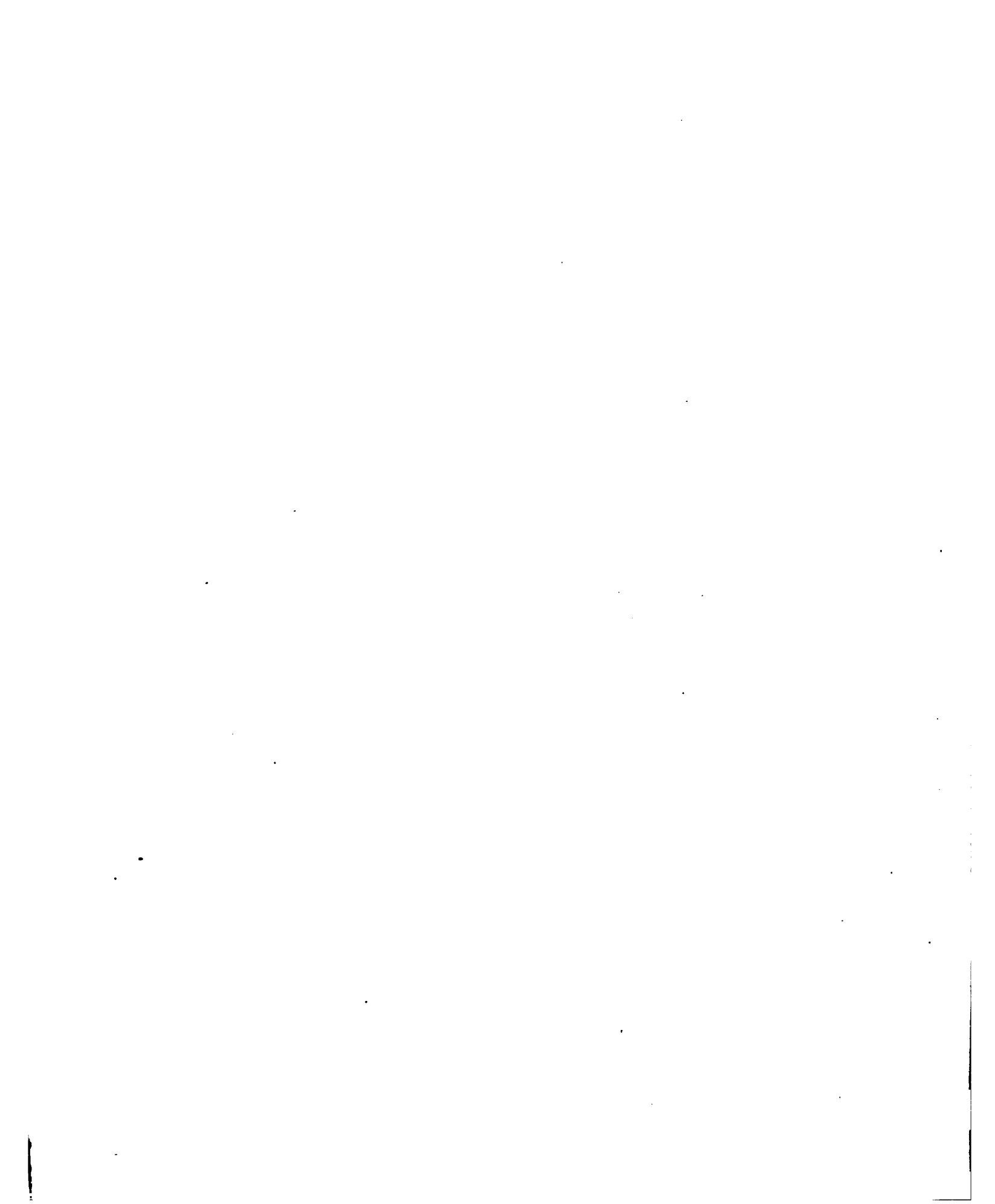


Fig. 3.

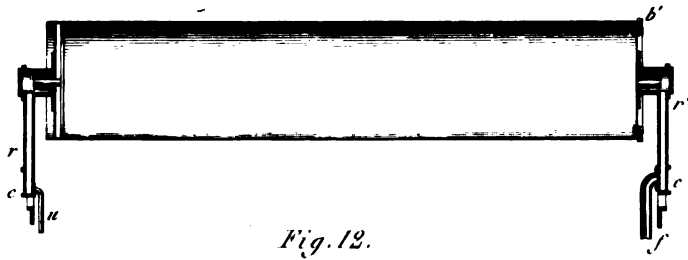


Fig. 12.

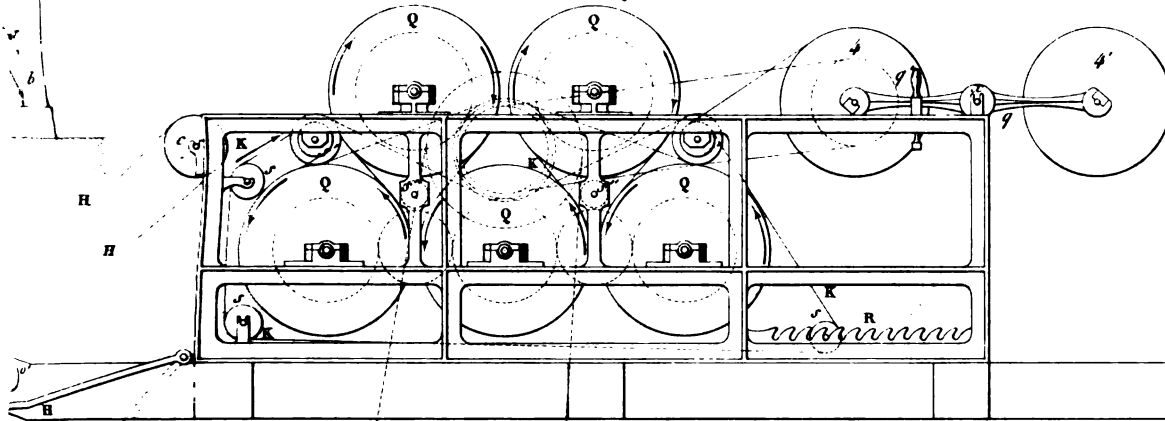
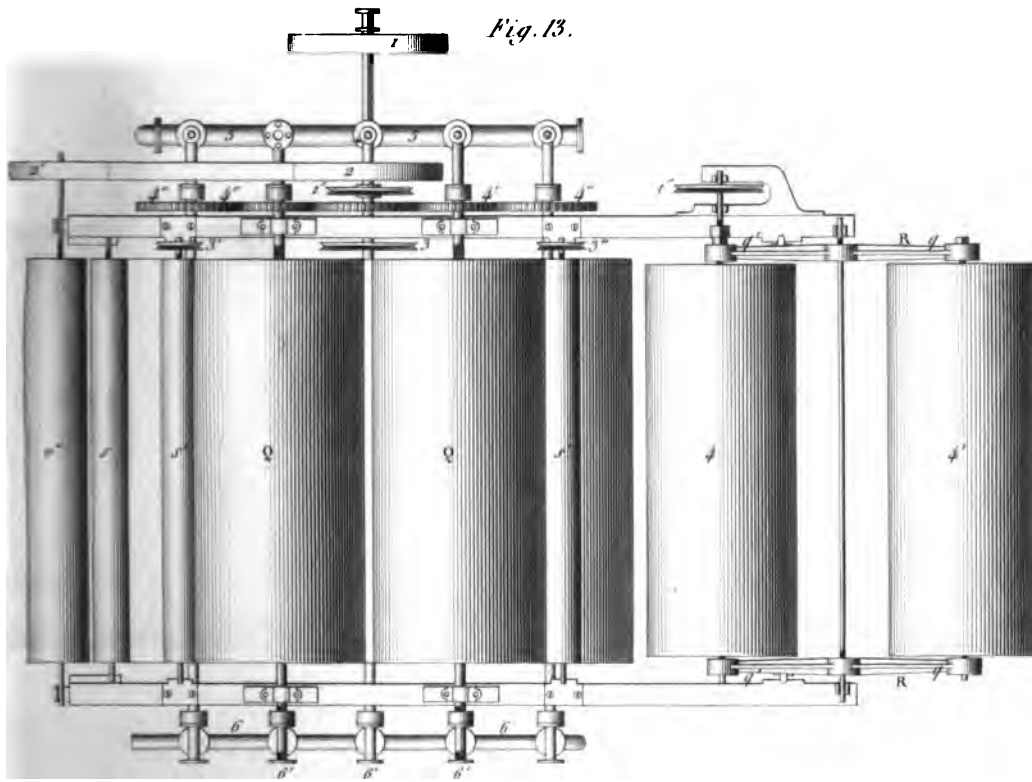


Fig. 13.





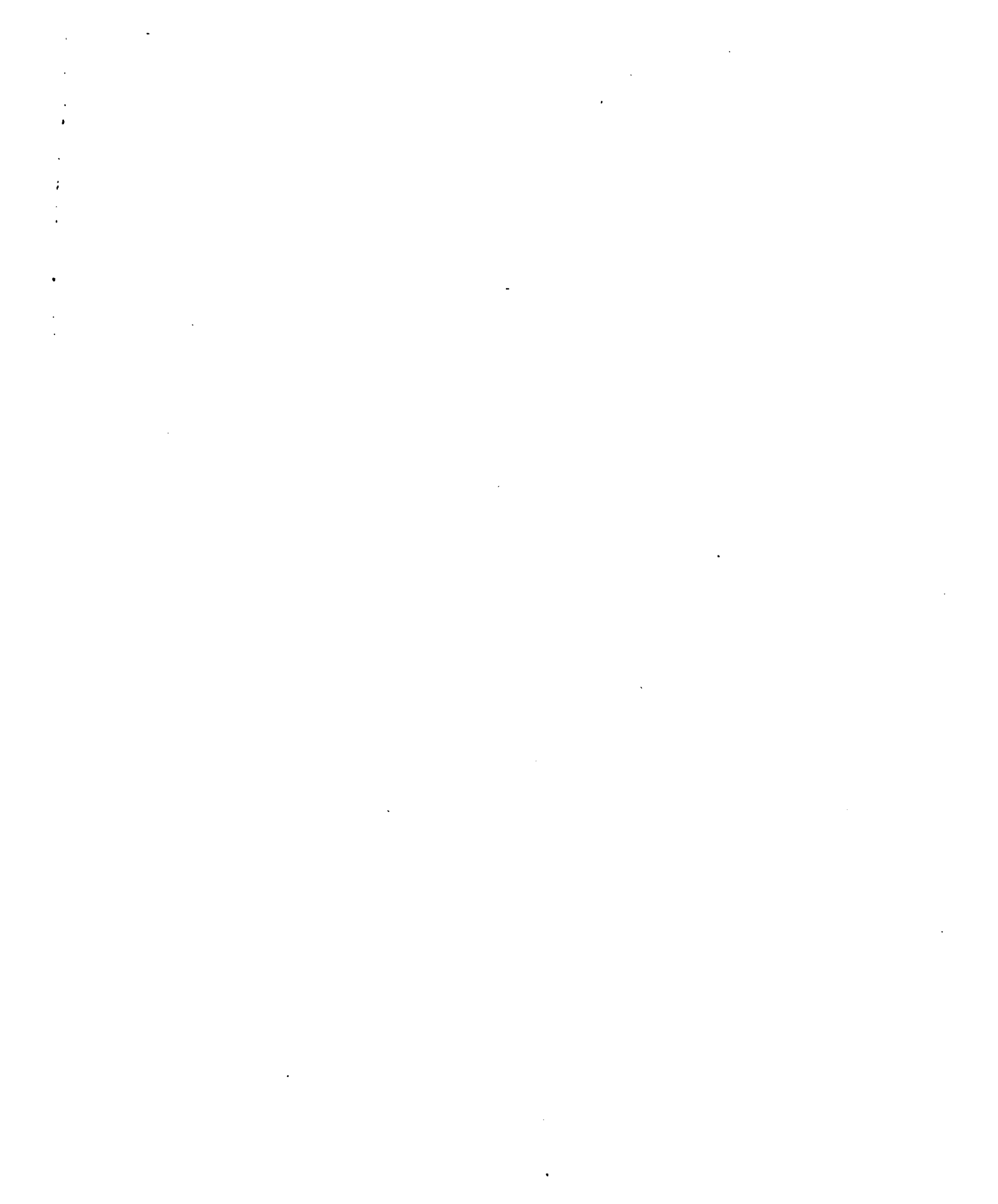


Fig. 5.

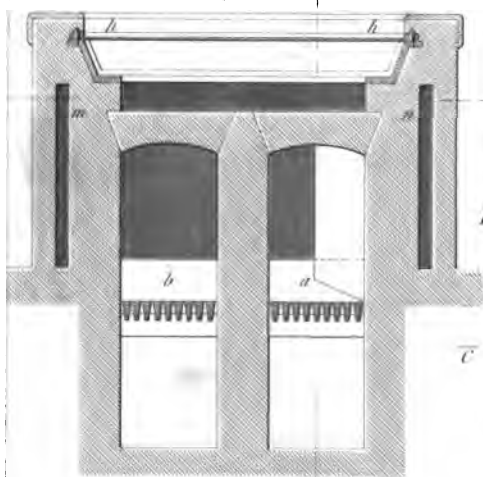


Fig. 4.

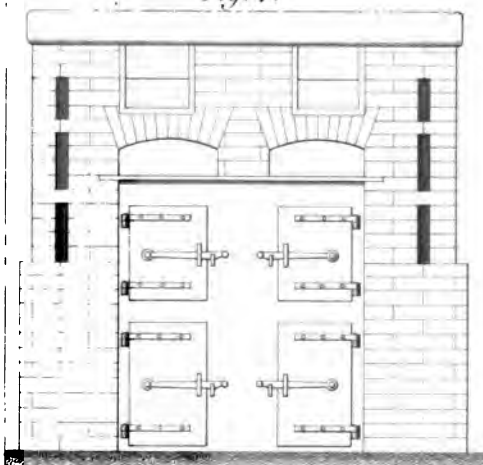
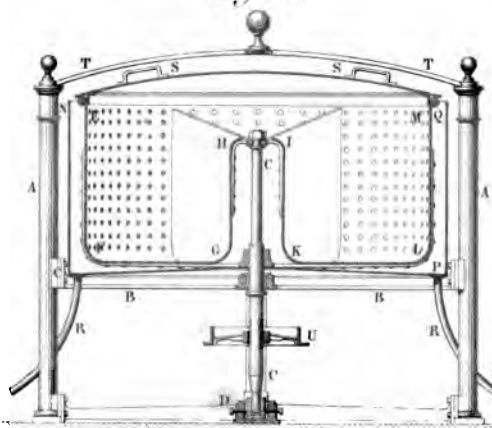
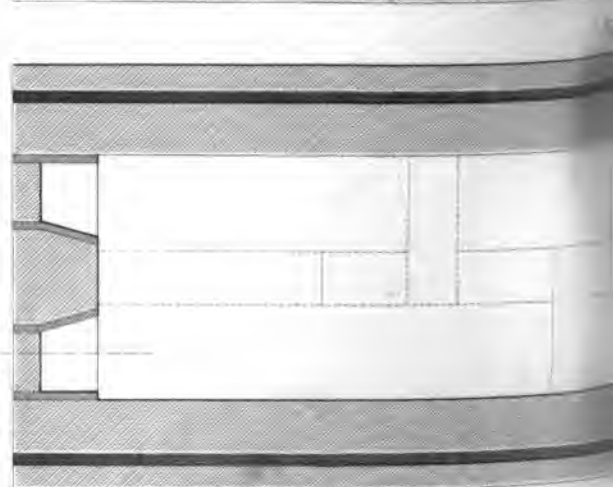
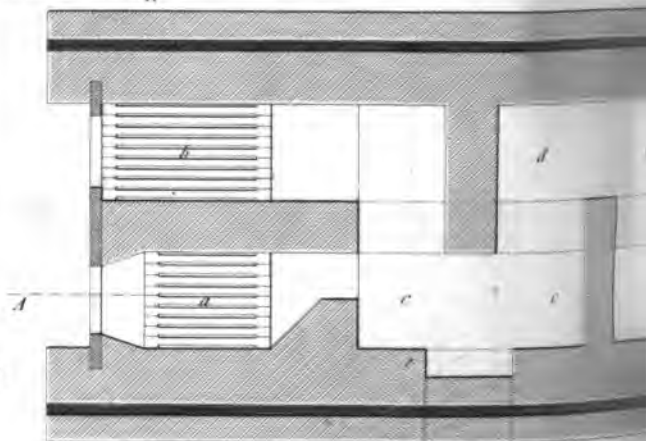
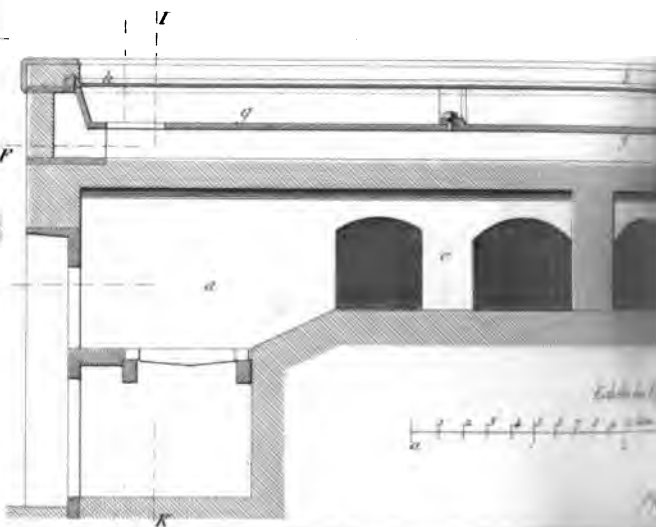
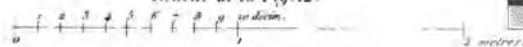
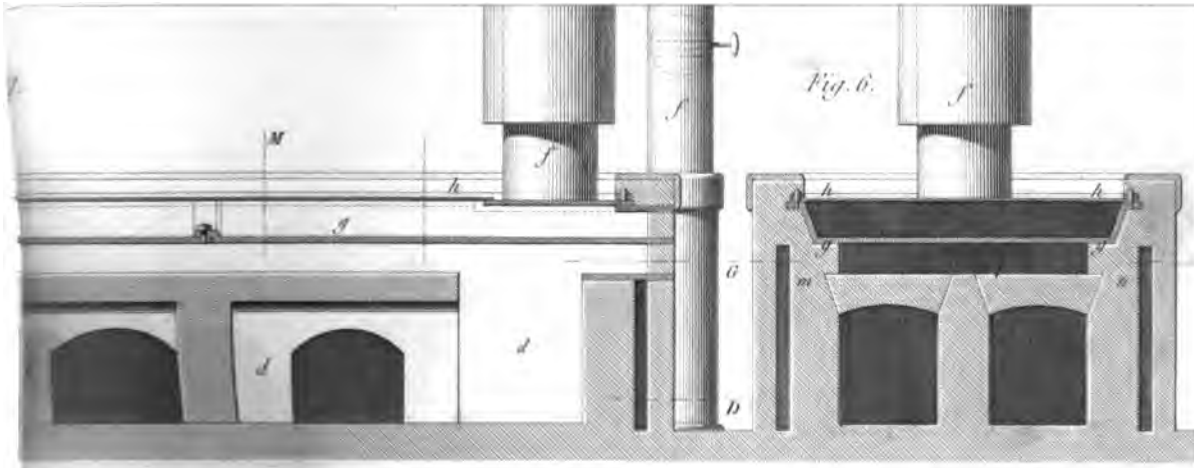


Fig. 12.



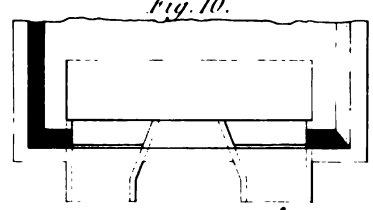
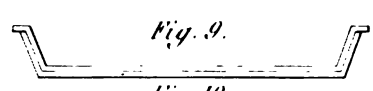
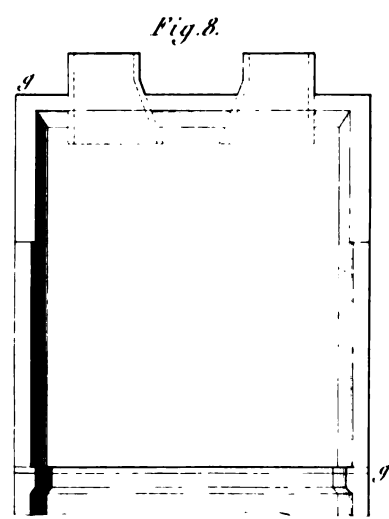
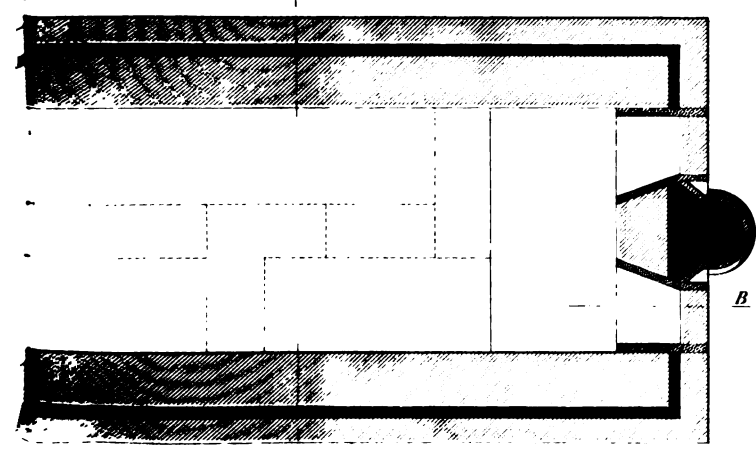
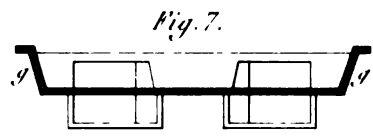
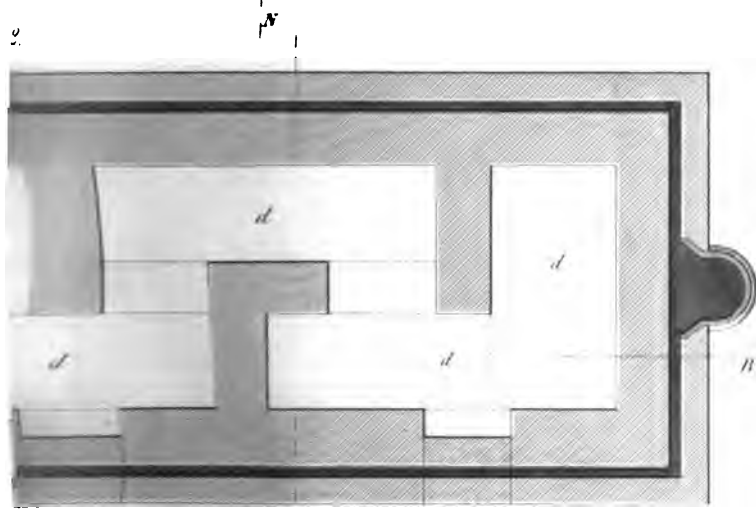
Echelle de la Fig. 12.

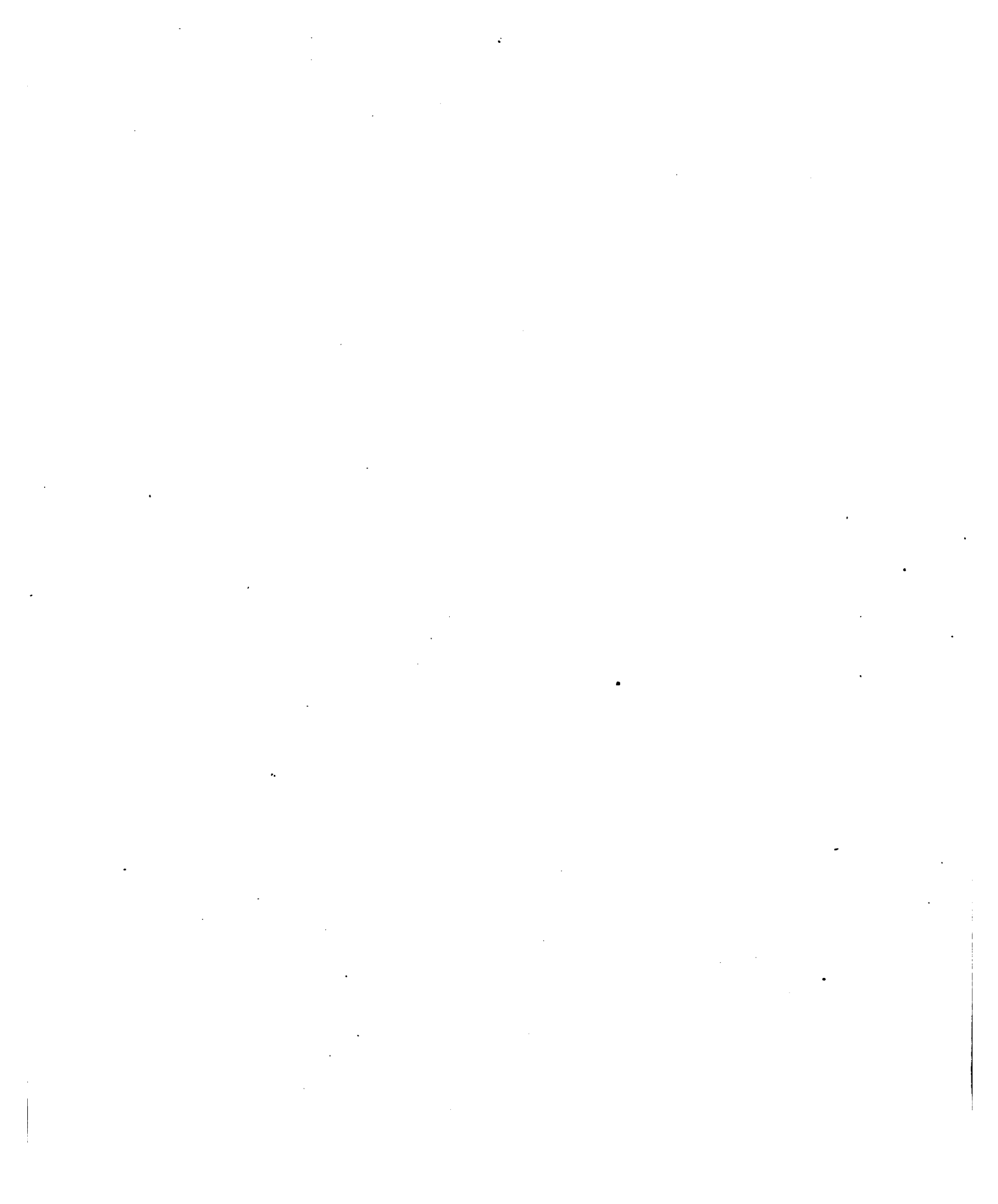


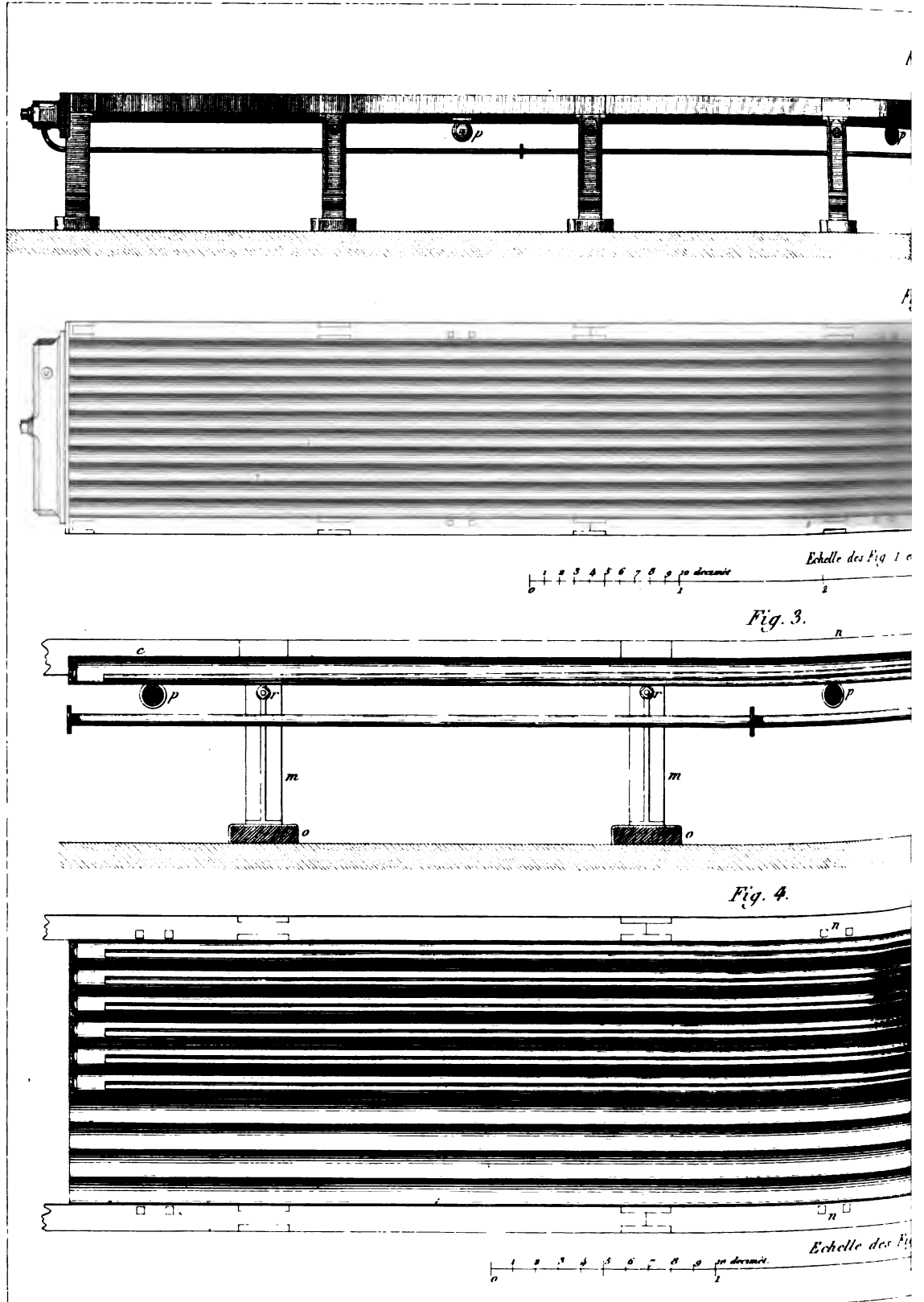


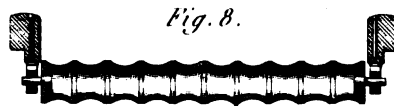
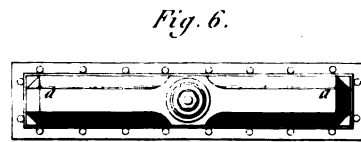
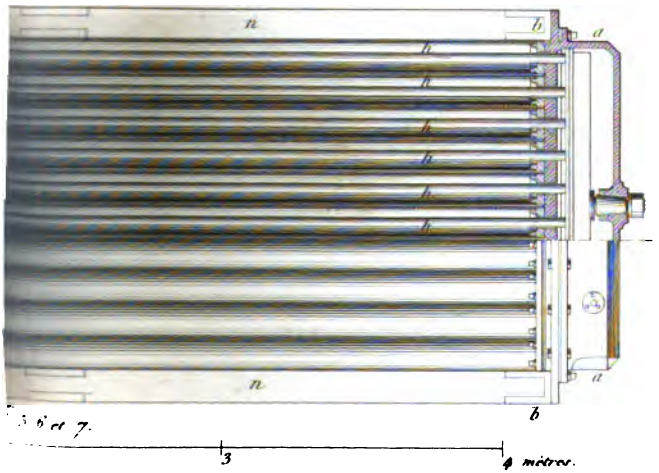
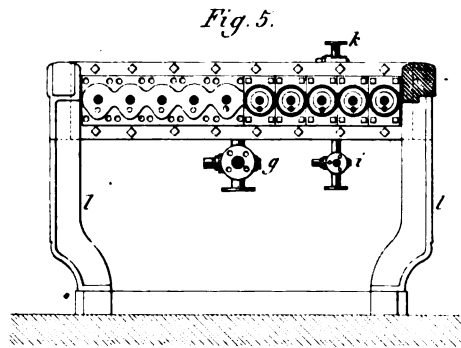
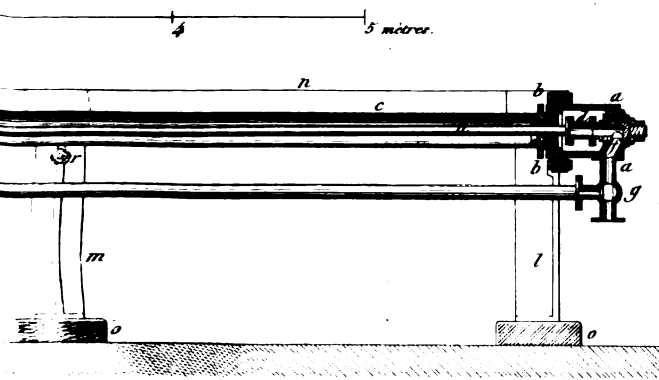
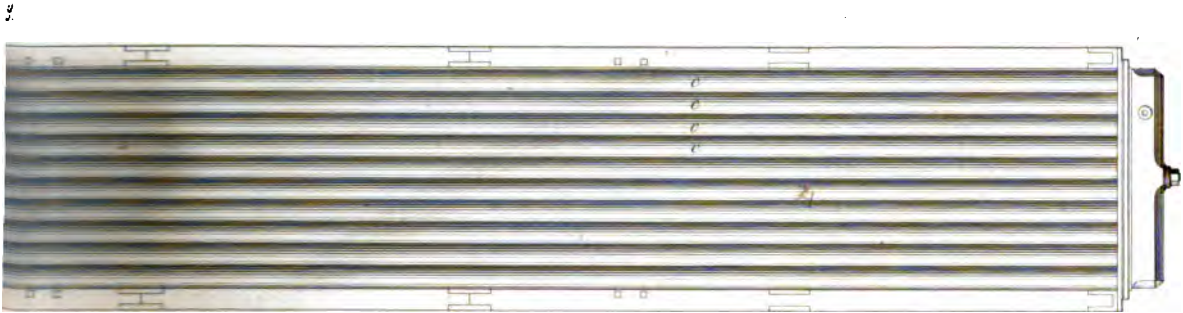
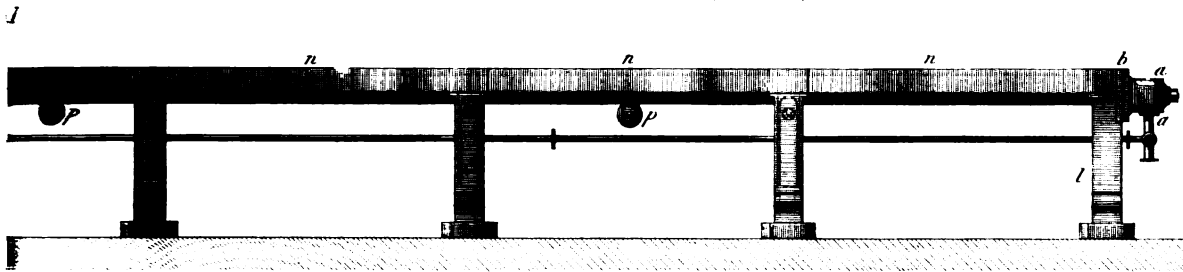
2, 3, 4, 5, 6, 7, 8, 9, 10 et 11.

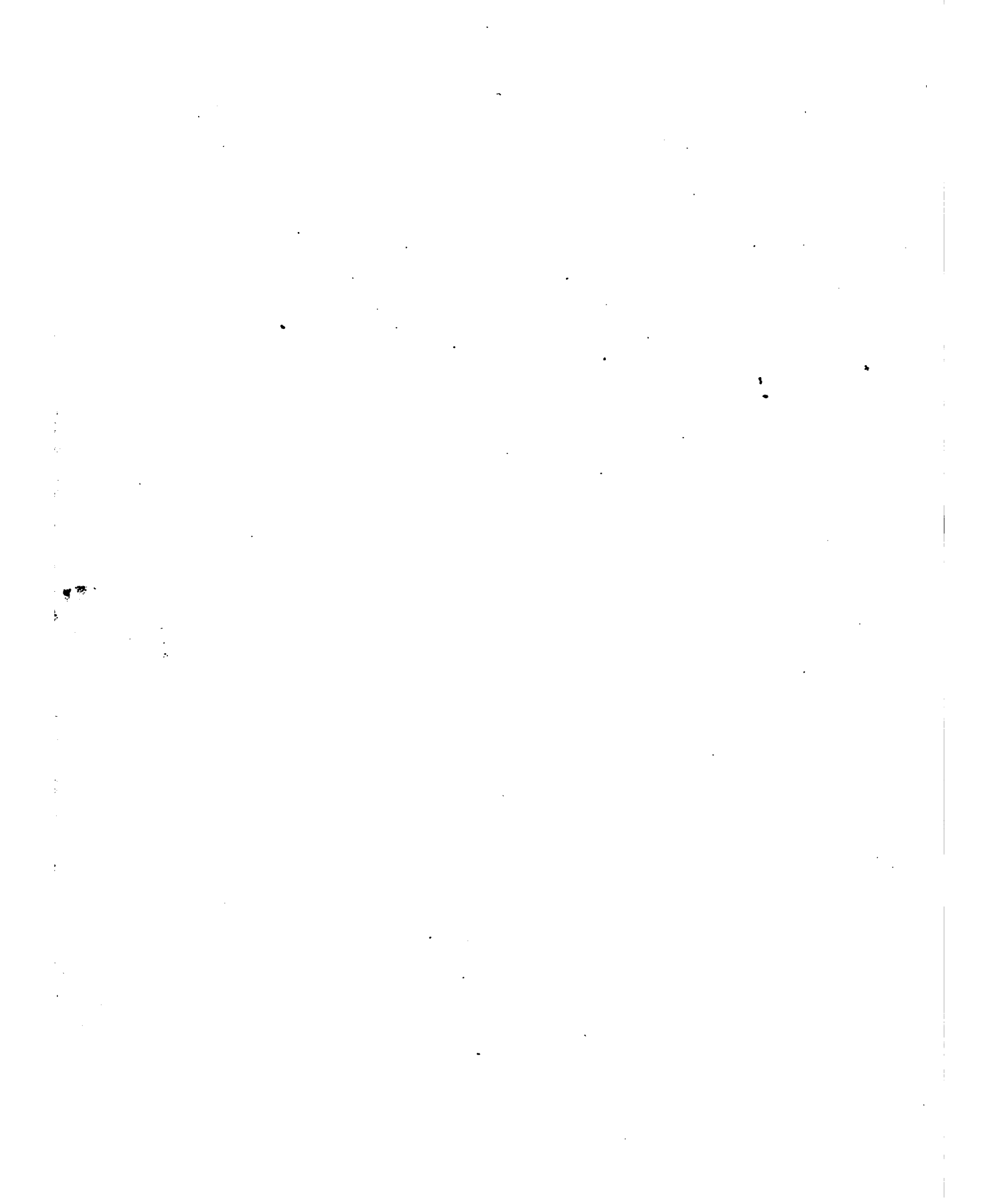
3 mètres.











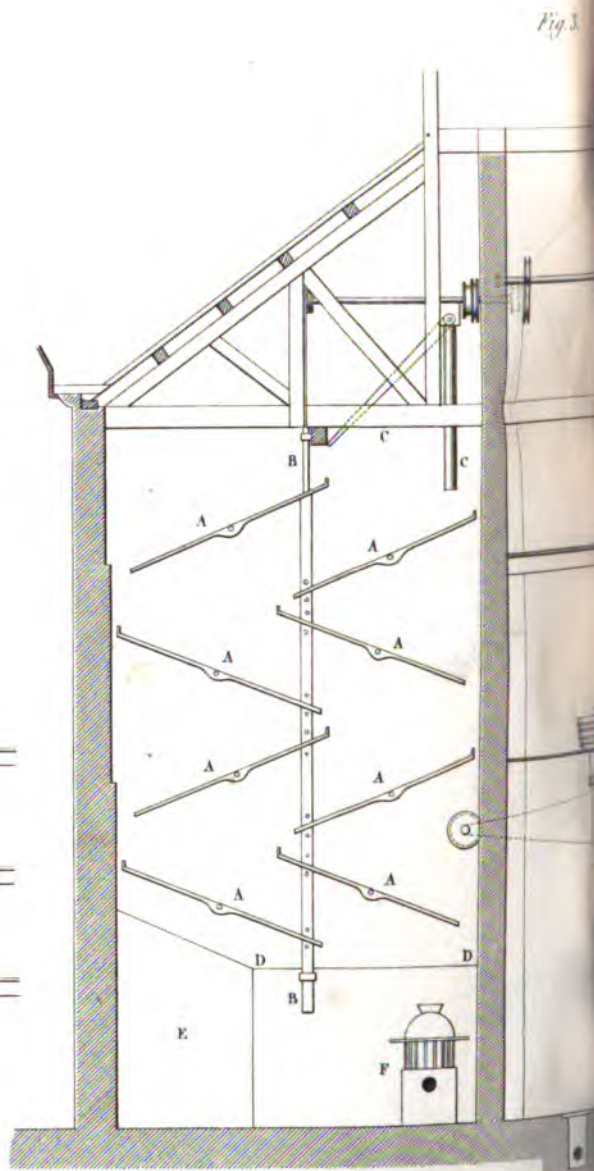
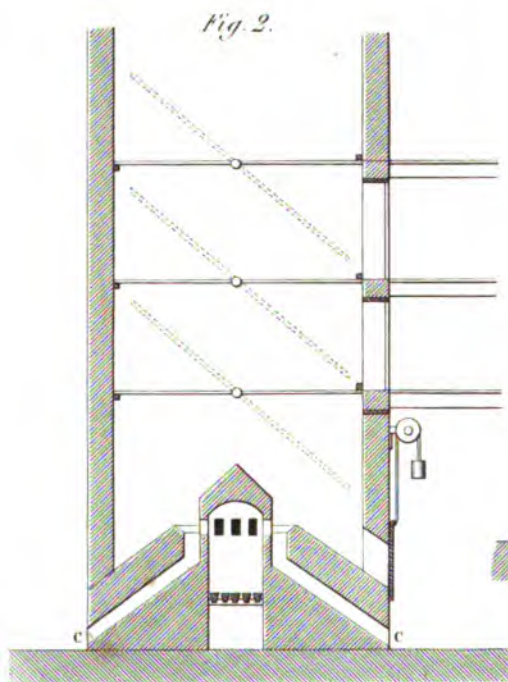
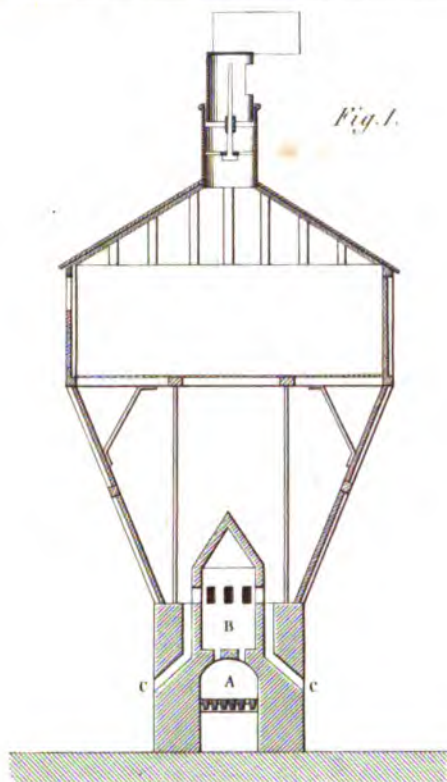


Fig. 4.

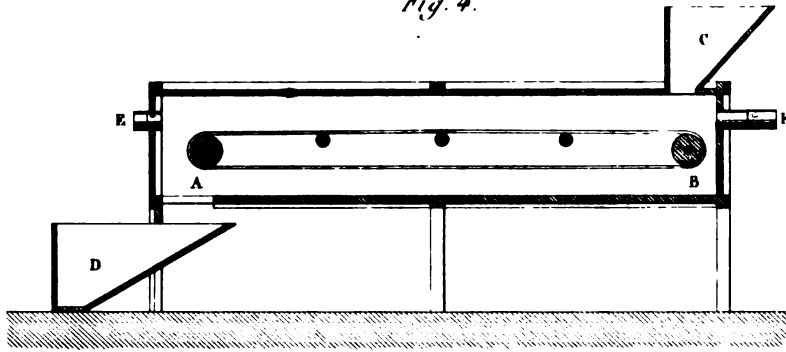


Fig. 5.

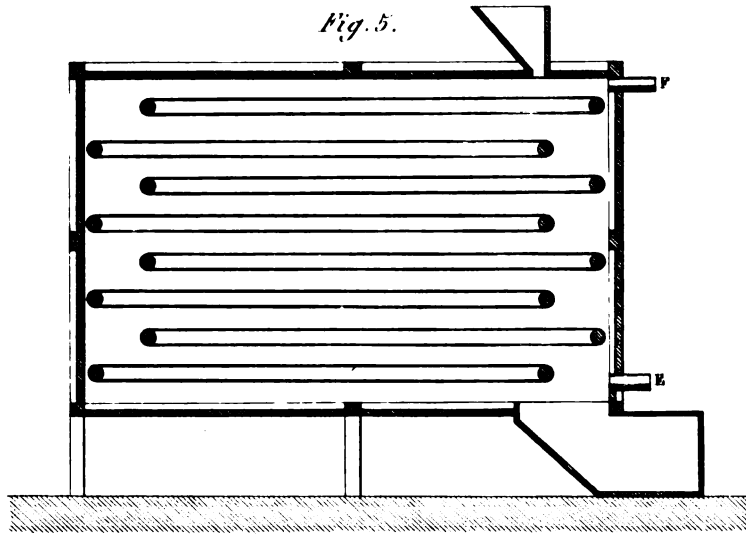
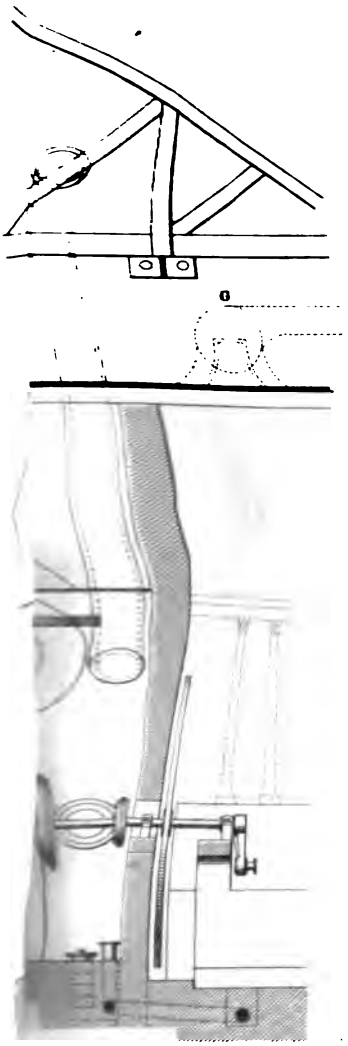
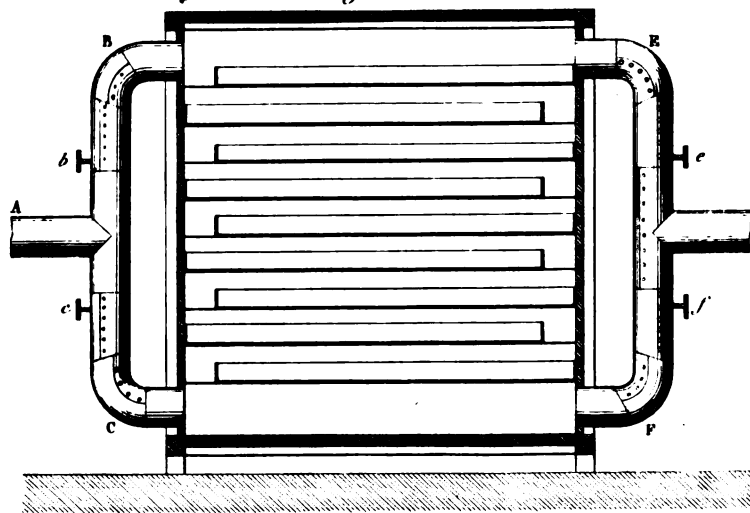


Fig. 6.



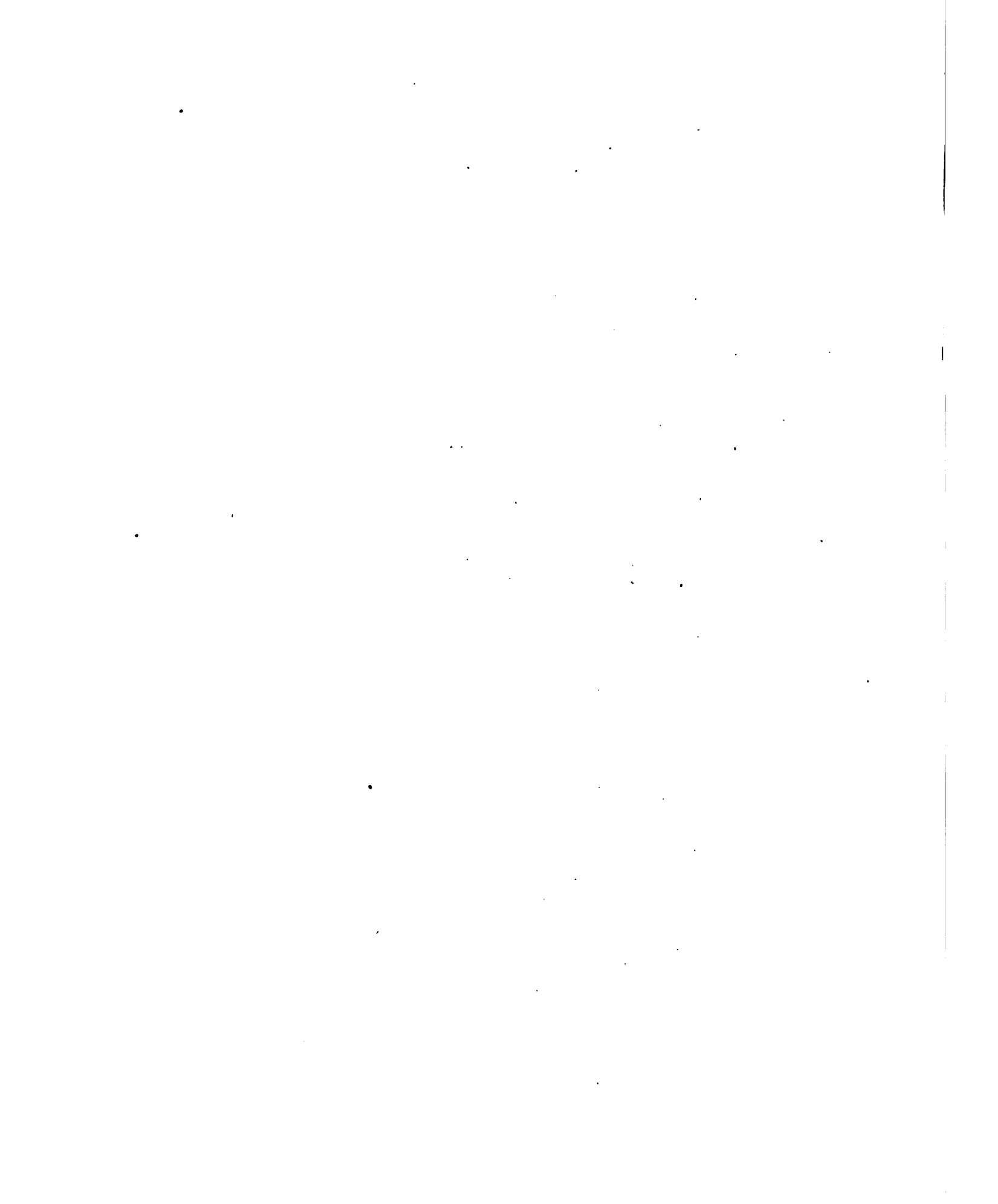




Fig. 1.

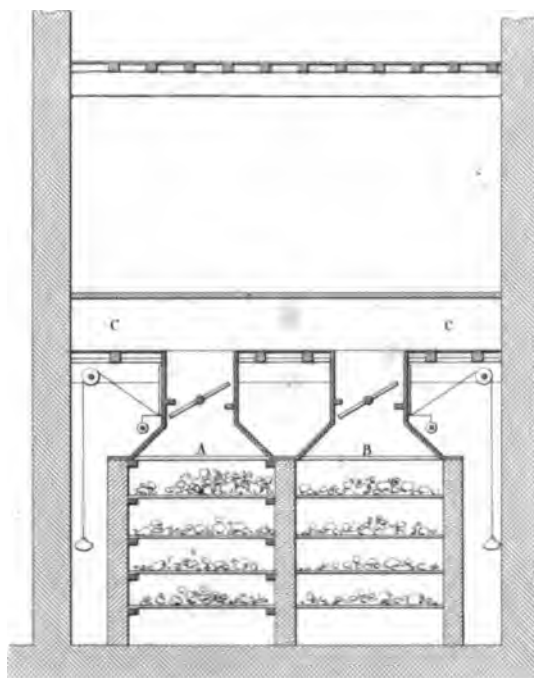


Fig. 2.

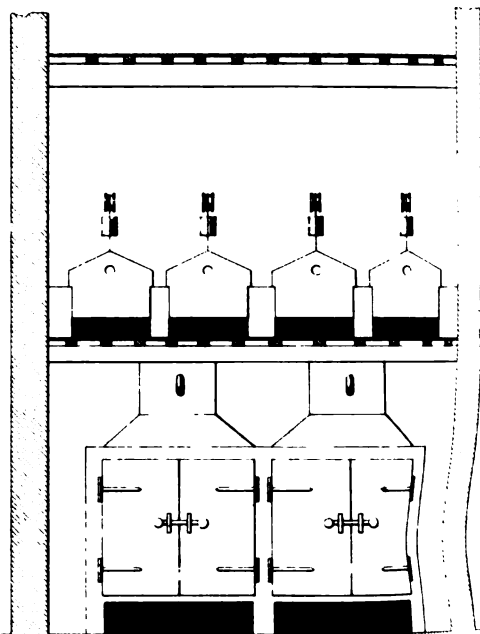


Fig. 3.

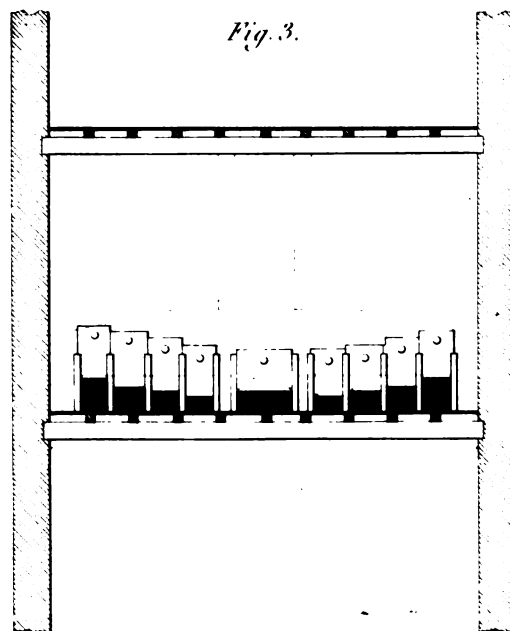
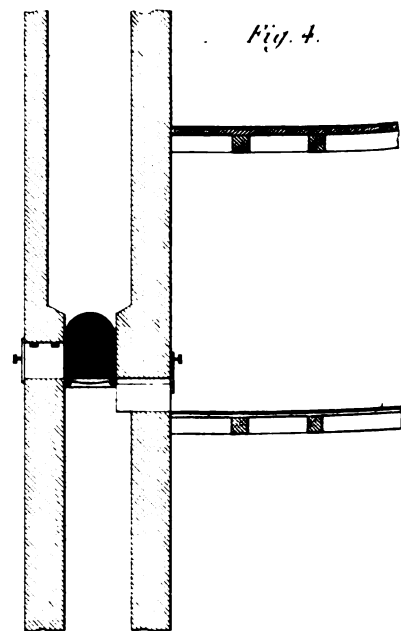


Fig. 4.



Echelle des Fig. 1, 2, 3 et 4.

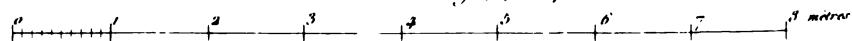


Fig. 5.

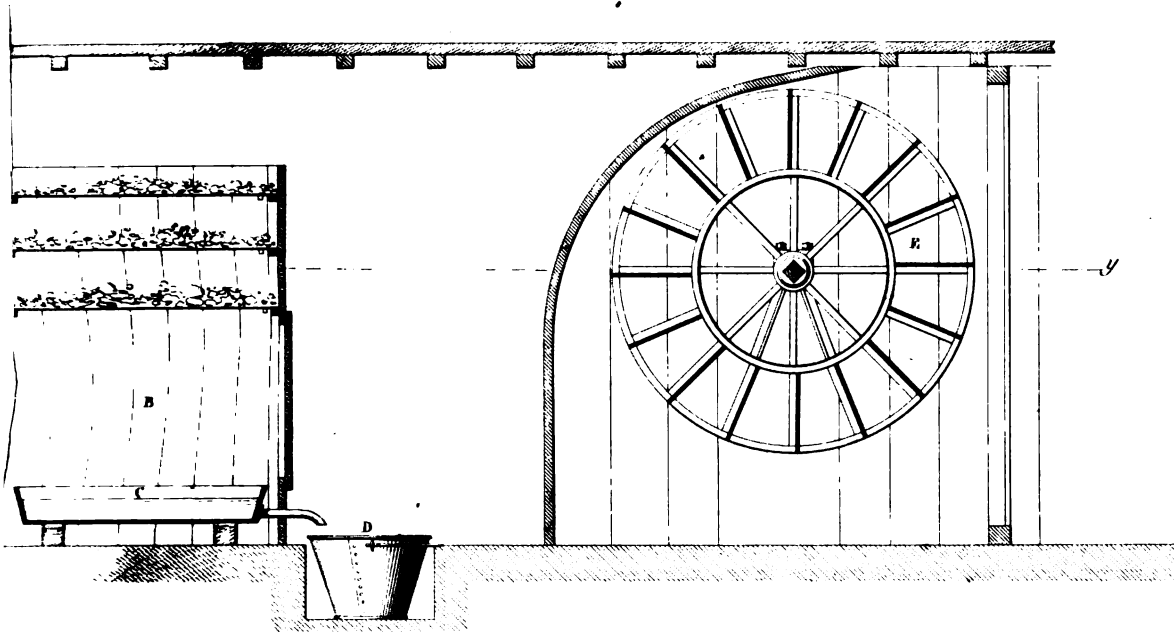
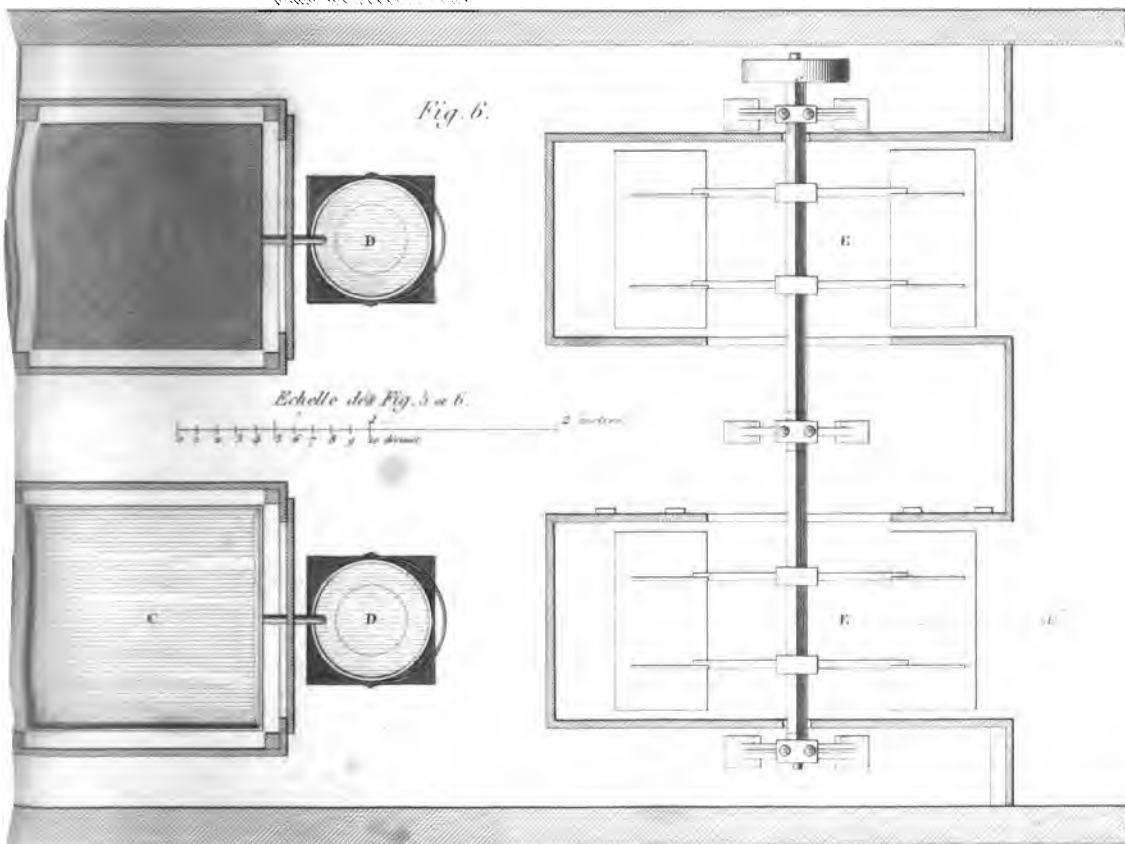
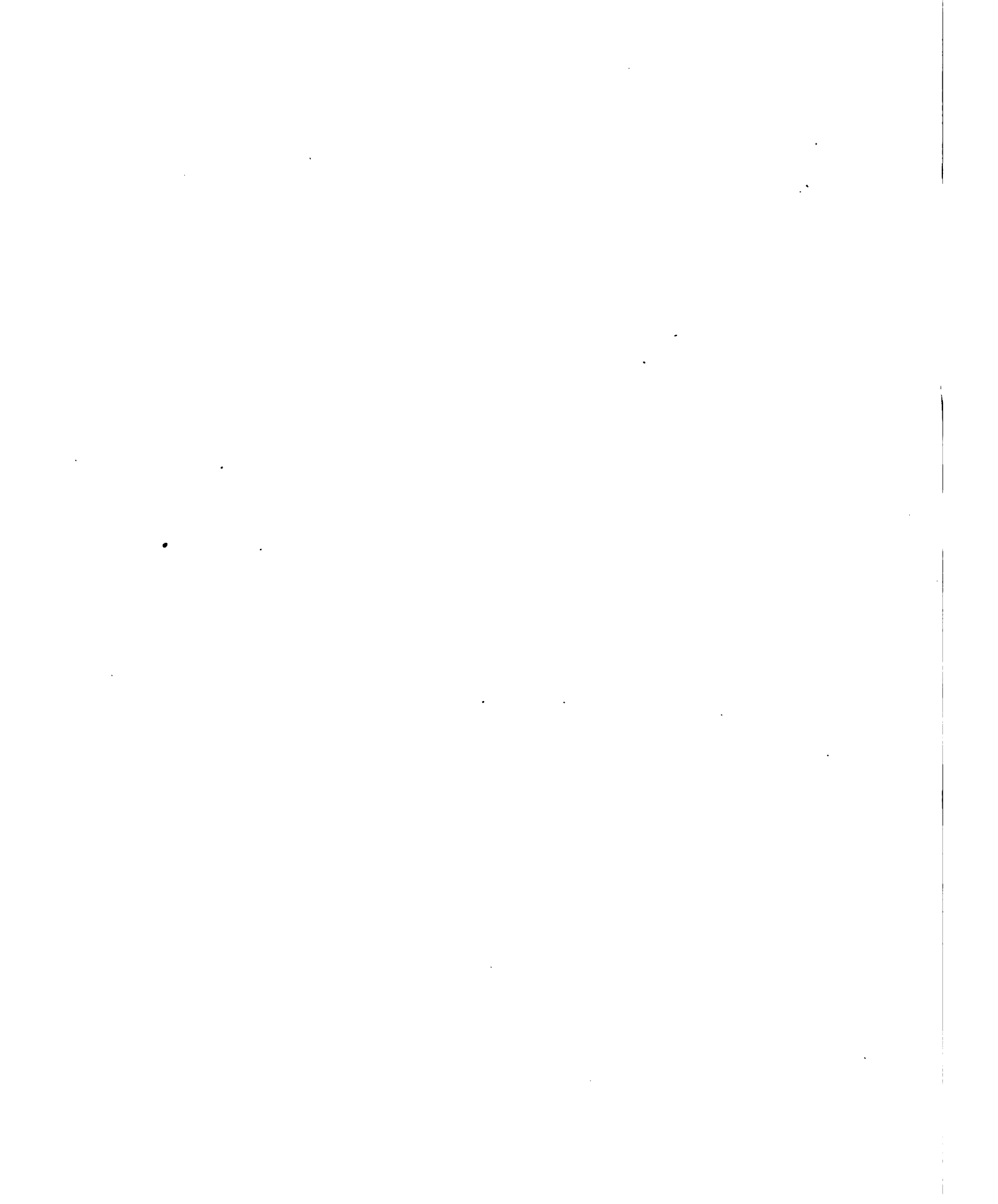
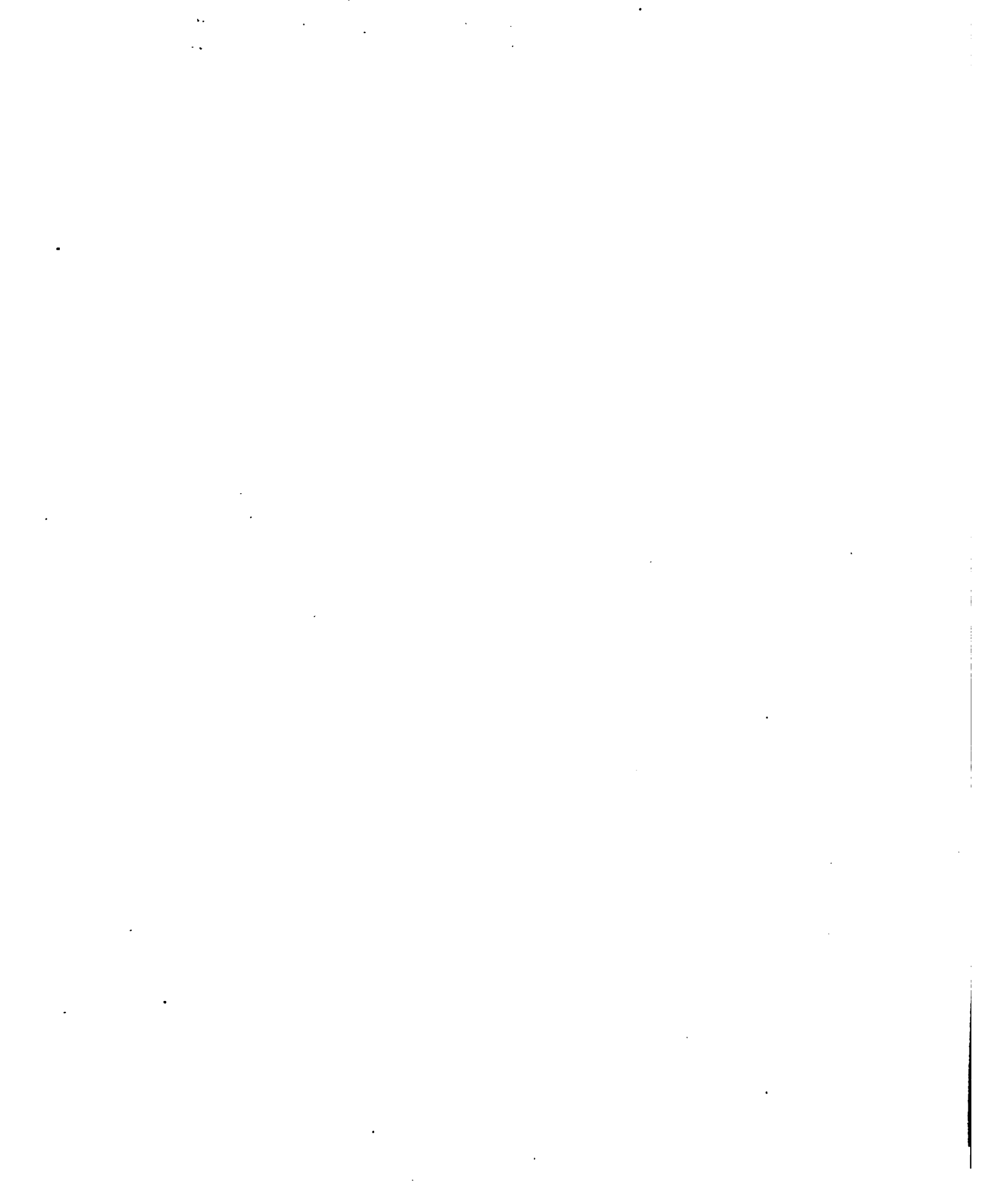
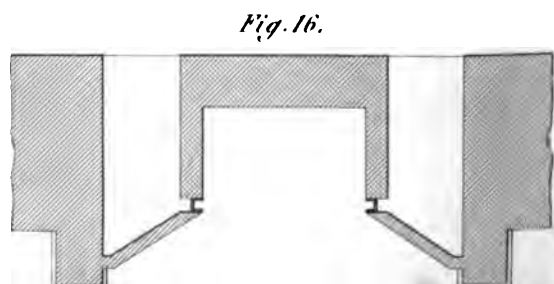
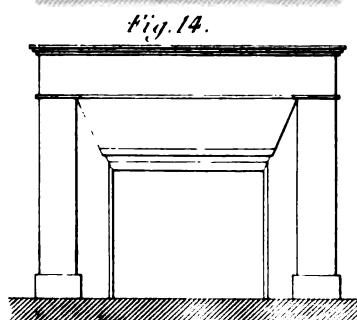
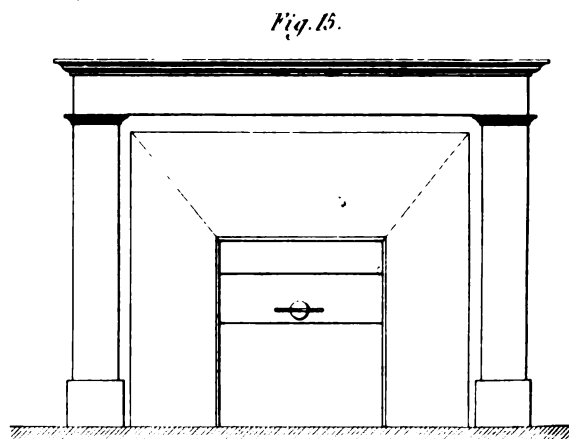
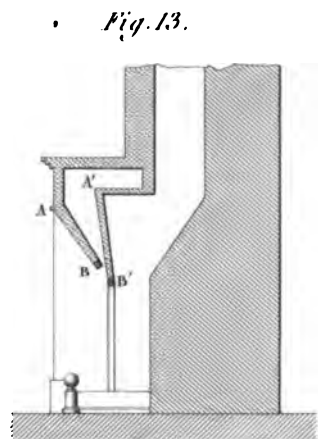
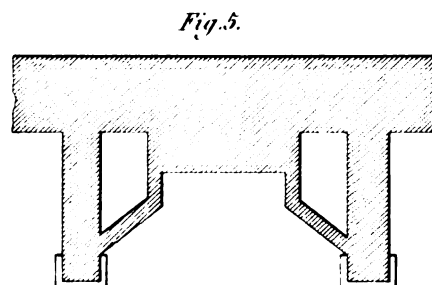
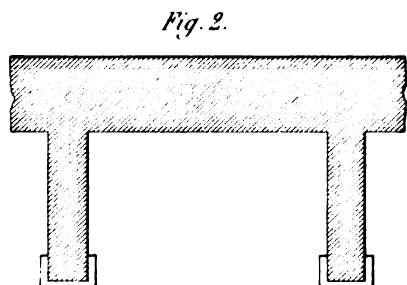
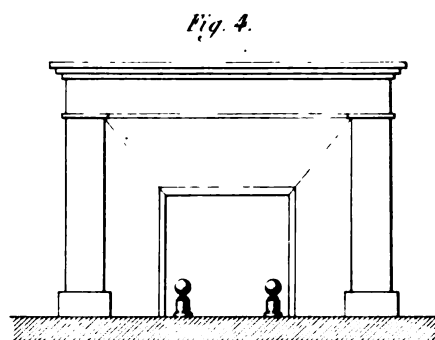
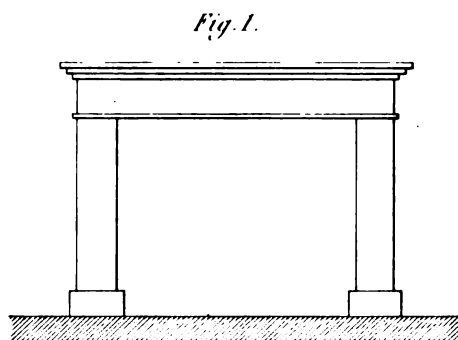


Fig. 6.









Echelle des Fig. 15, 16, 17 et 18.

Fig. 6.

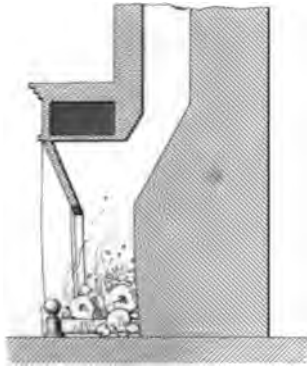


Fig. 11.

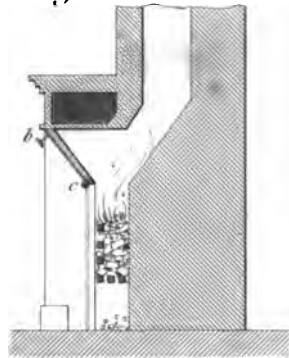


Fig. 10.

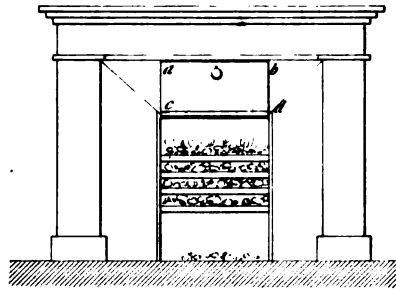


Fig. 8.

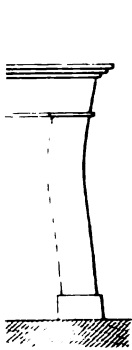


Fig. 9.

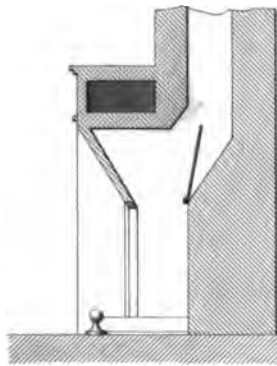


Fig. 12.

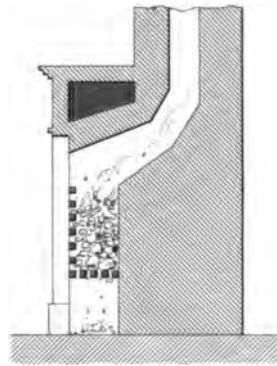


Fig. 19.

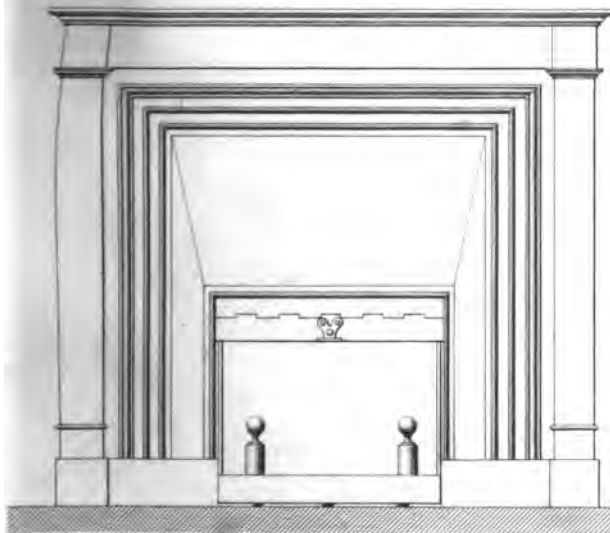


Fig. 20.

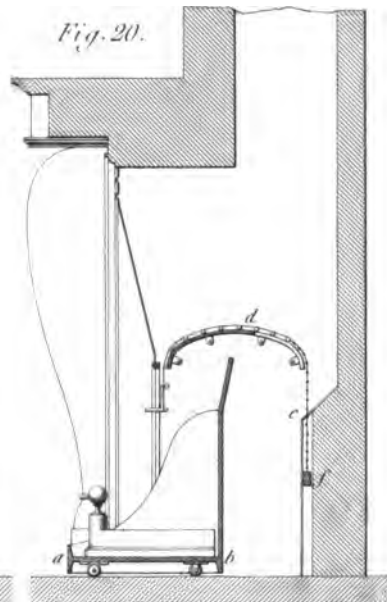
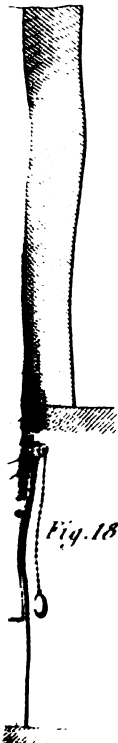
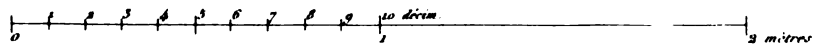
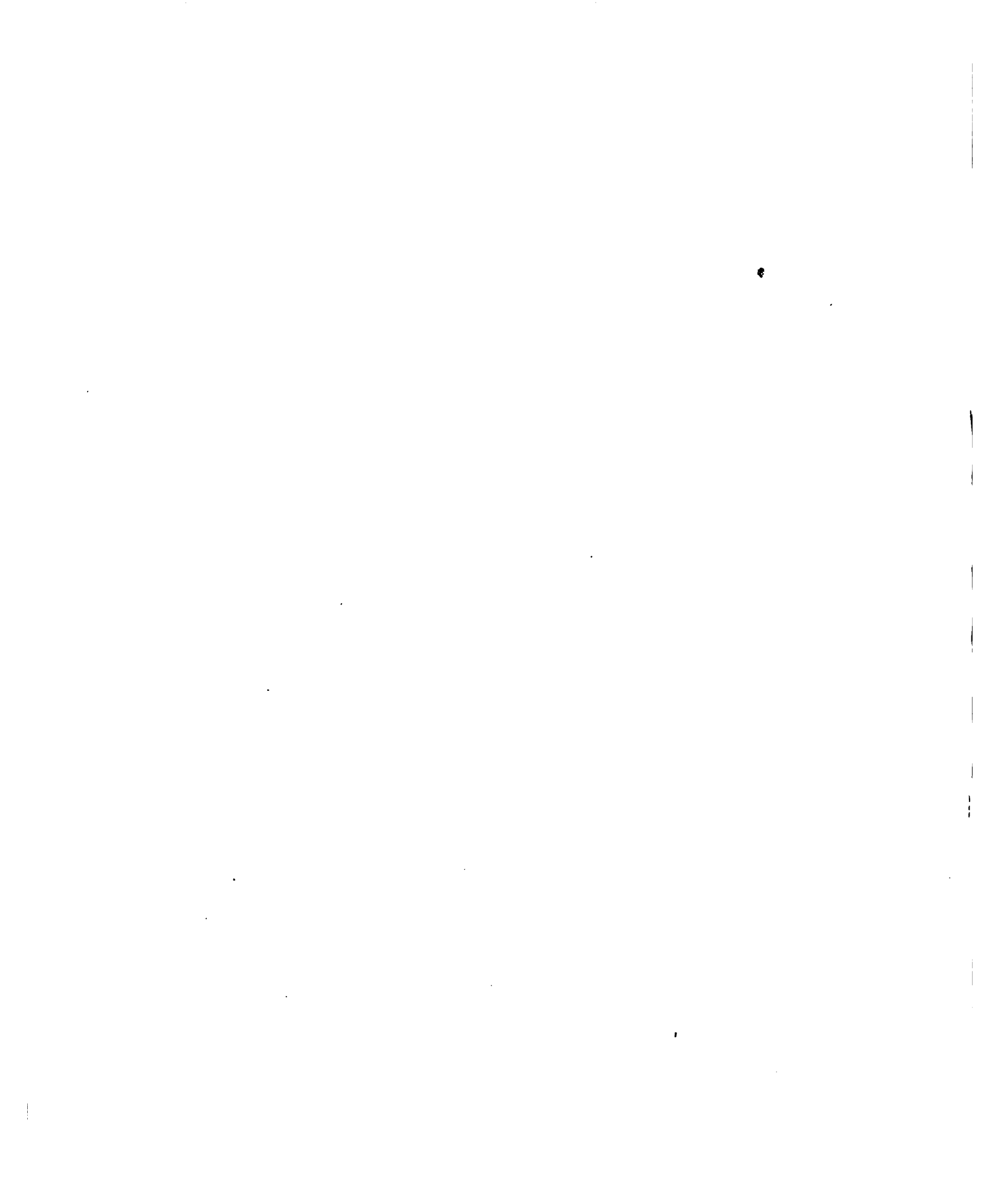


Fig. 18.



Echelle des Fig. 19 et 20.





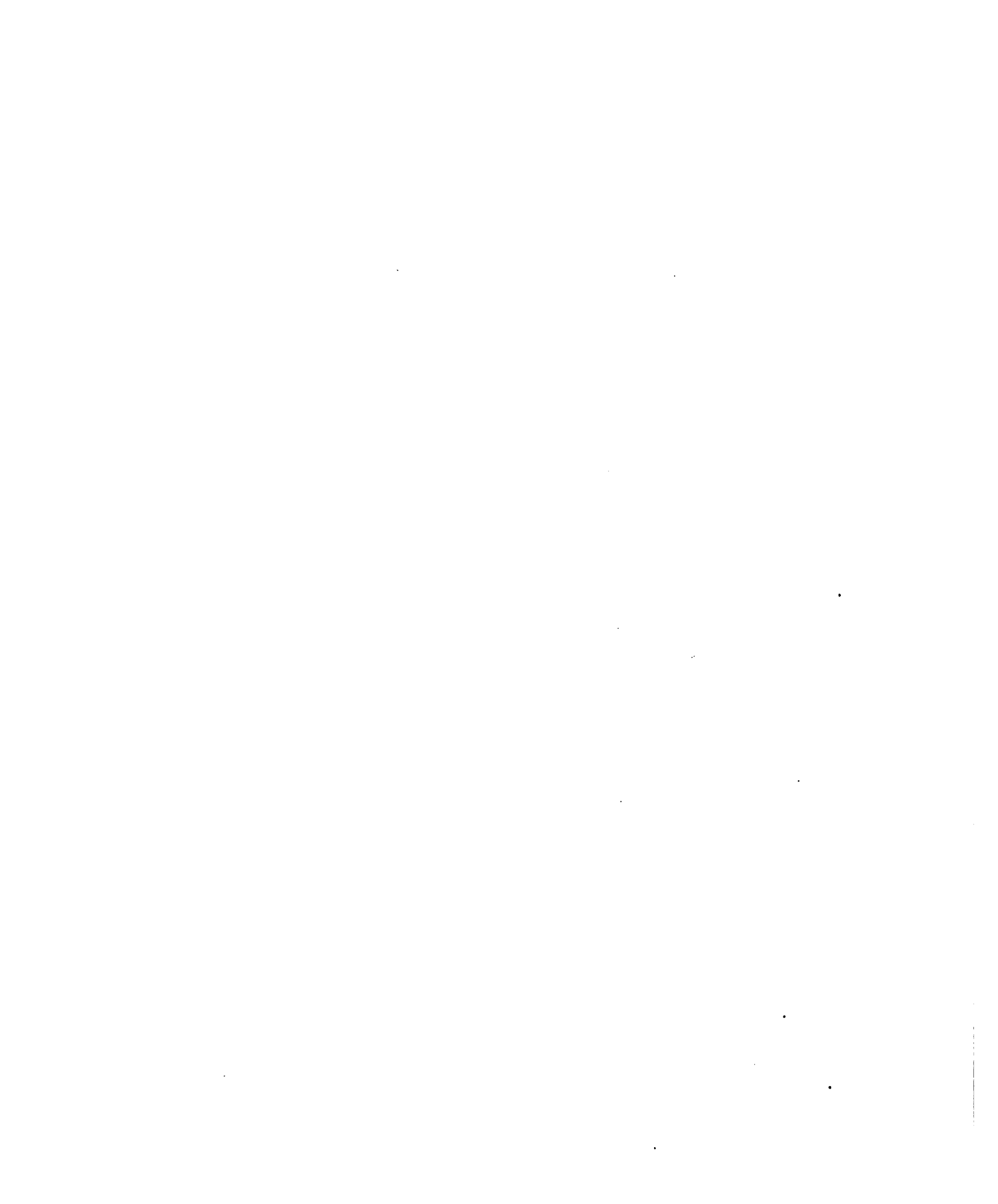


Fig. 2.

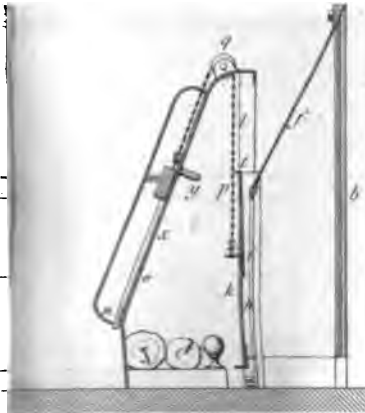


Fig. 9.

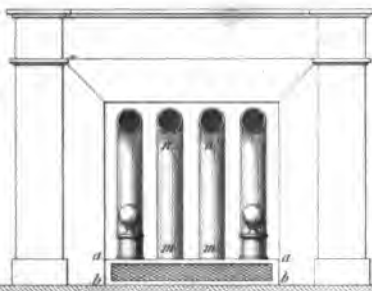


Fig. 10.

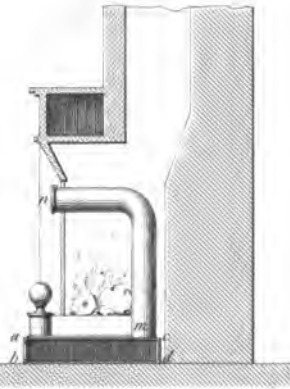


Fig. 11.

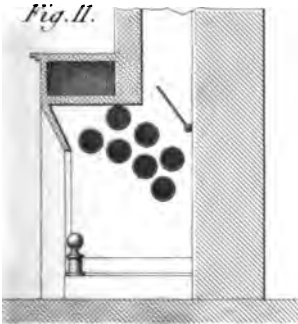


Fig. 8.

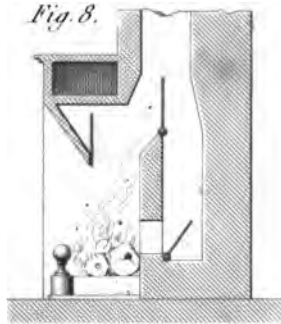


Fig. 14.

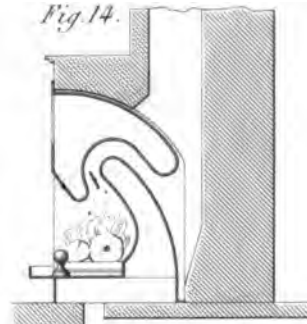


Fig. 18.

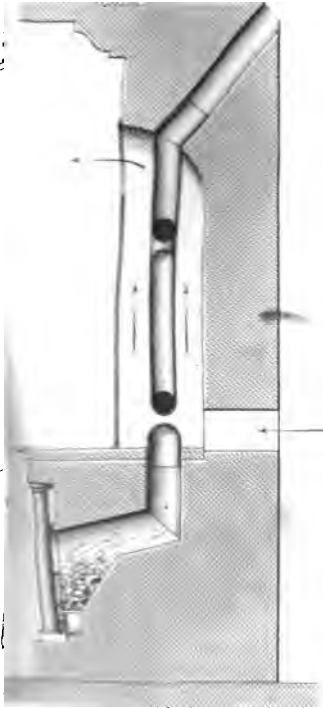


Fig. 19.

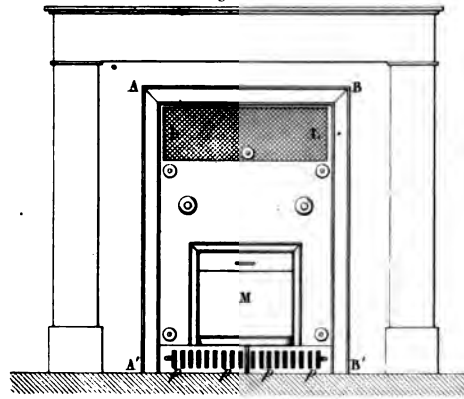


Fig. 20.

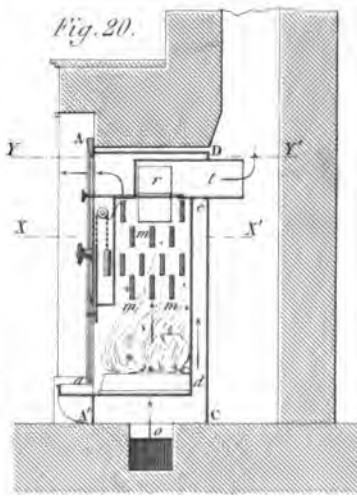


Fig. 21.

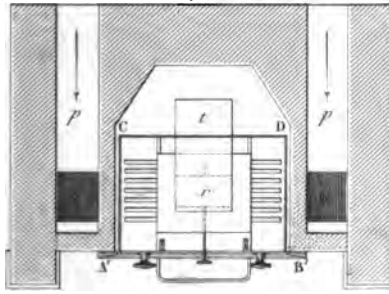
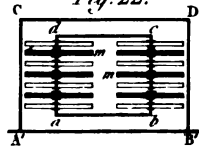
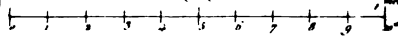
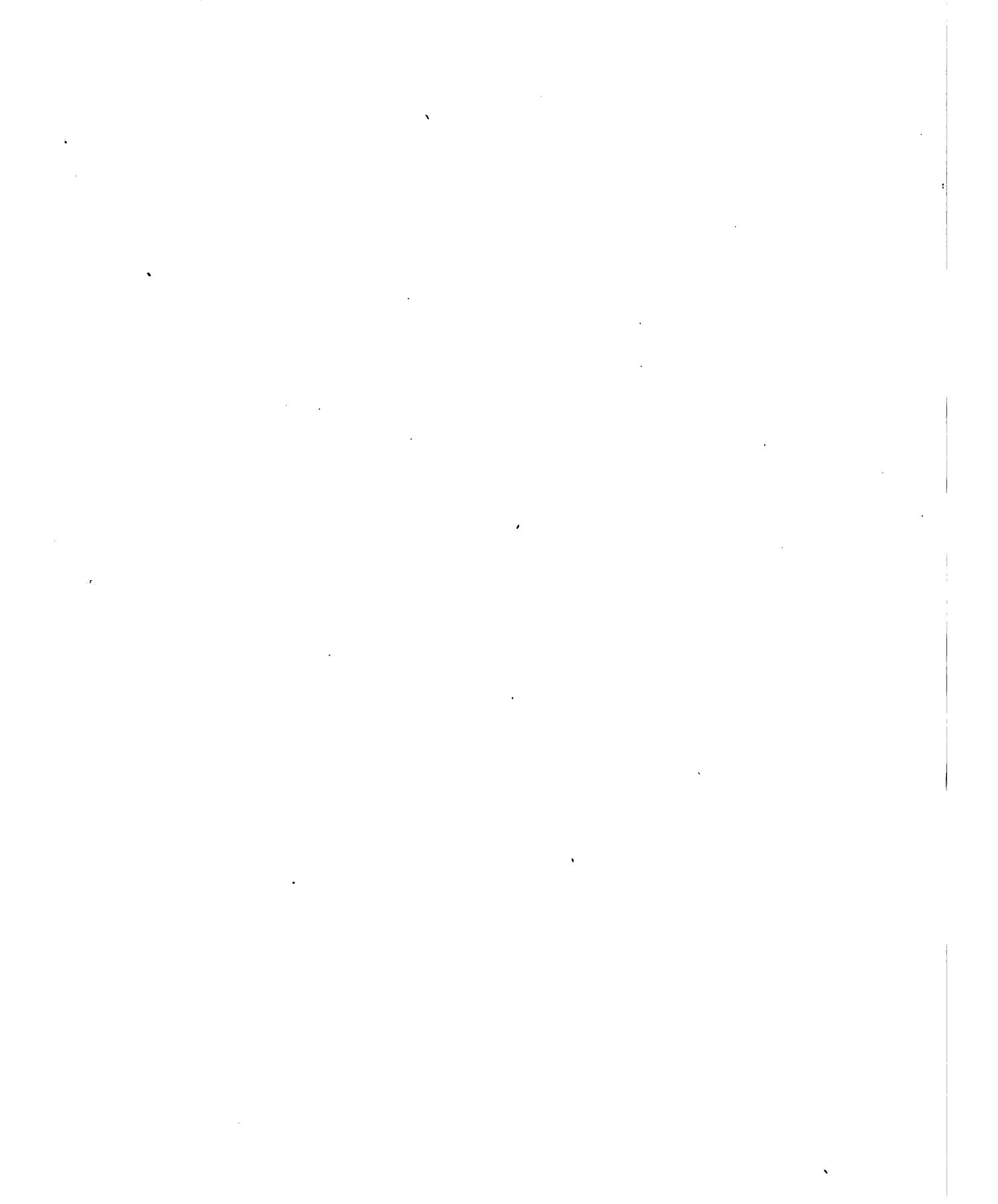


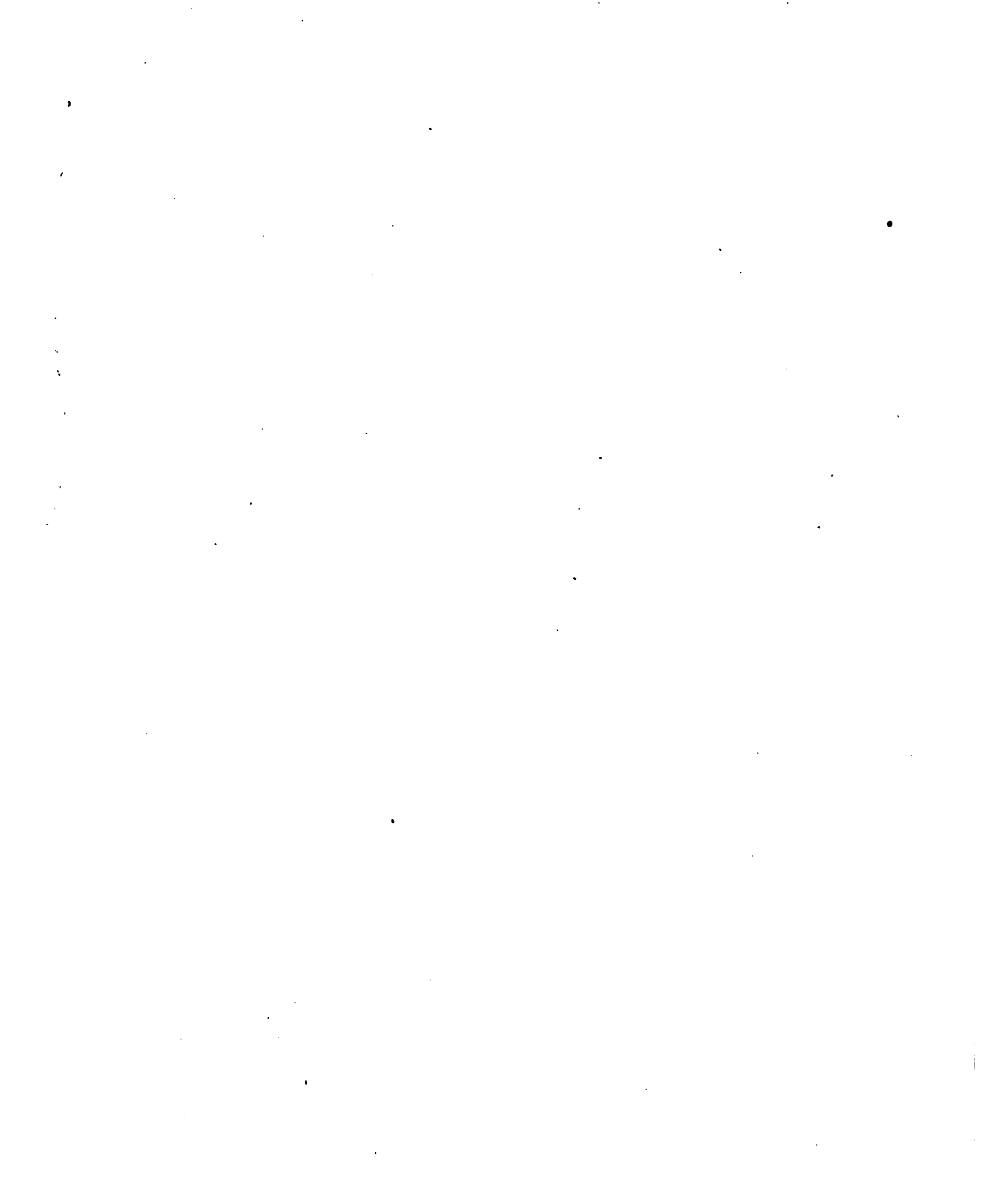
Fig. 22.



Echelle des Fig. 10, 20, 21 et 22.







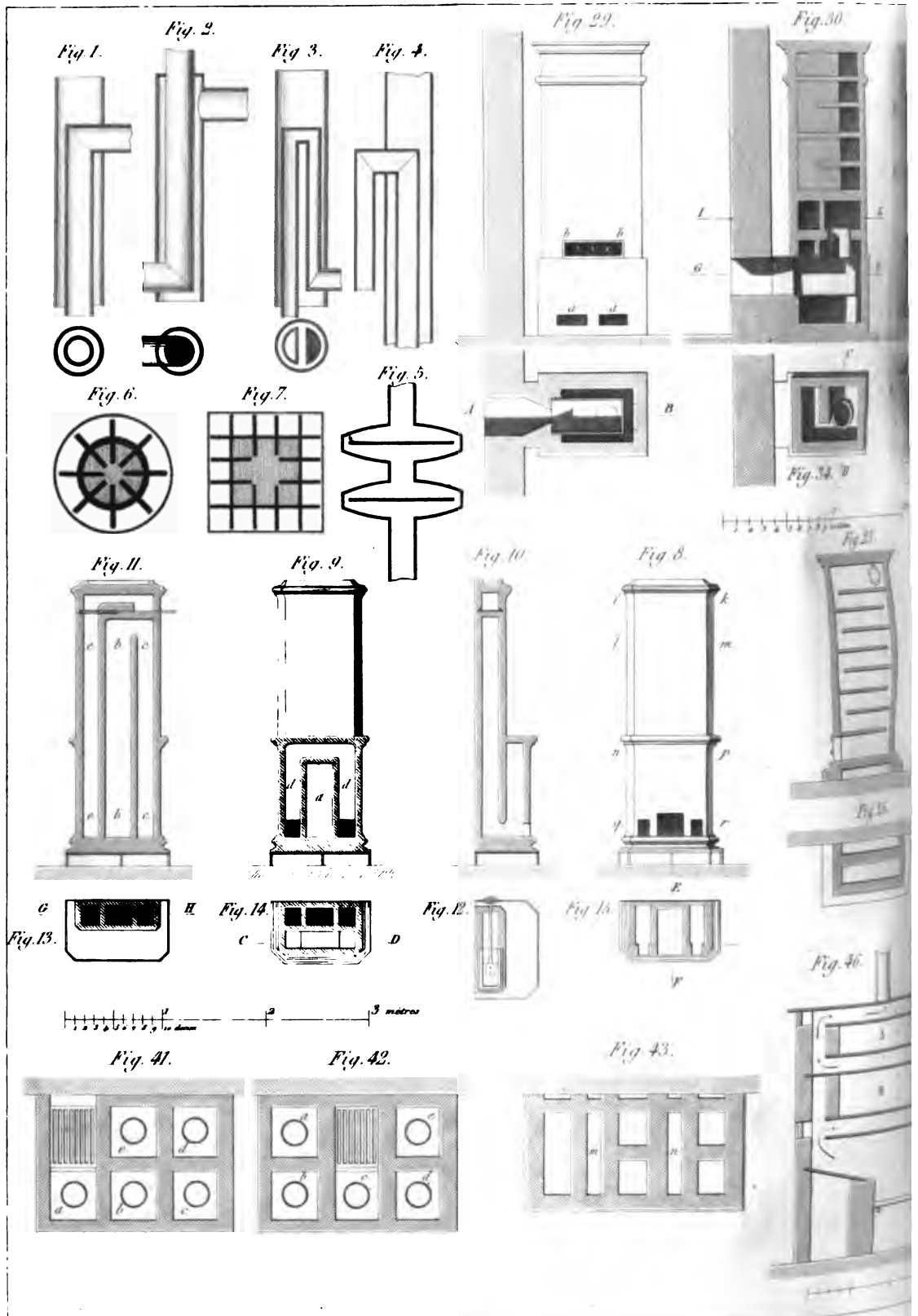




Fig. 31.

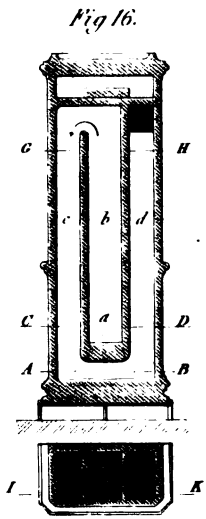


Fig. 16.

Fig. 19.



Fig. 17.

Fig. 20.

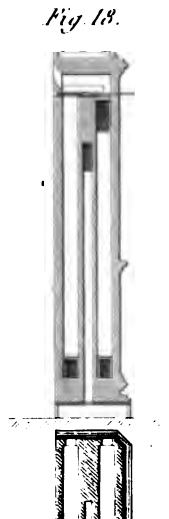


Fig. 18.

Fig. 21.

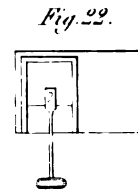


Fig. 22.

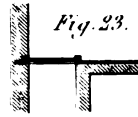


Fig. 23.



Fig. 24.



Fig. 36.

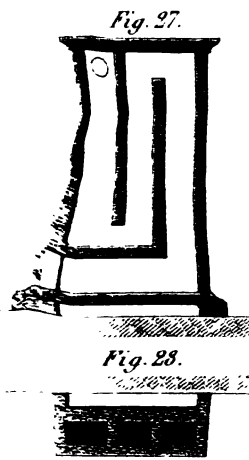


Fig. 27.

Fig. 28.

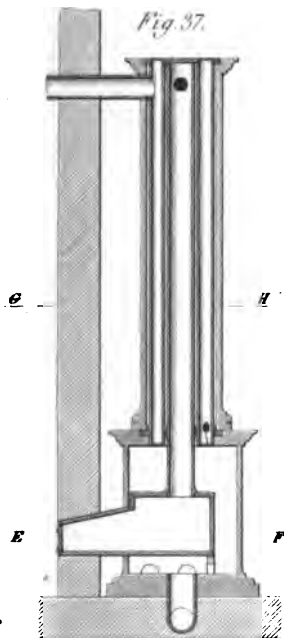


Fig. 37.

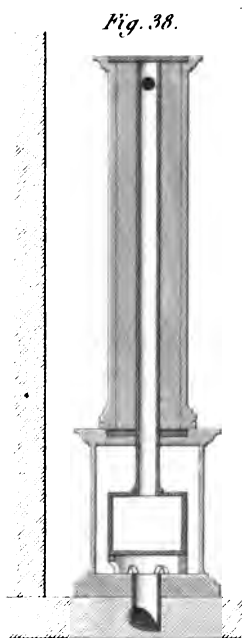


Fig. 38.

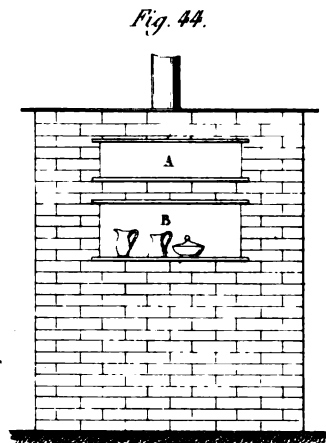


Fig. 44.

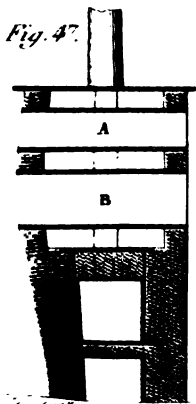


Fig. 47.

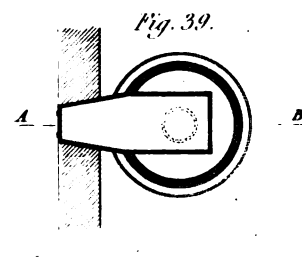


Fig. 39.

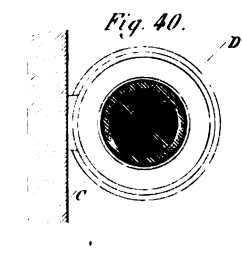


Fig. 40.

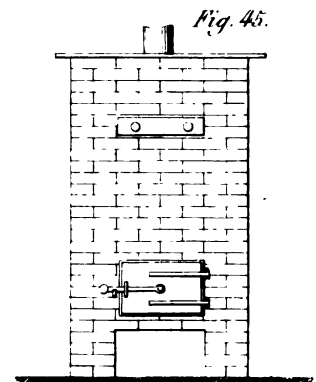
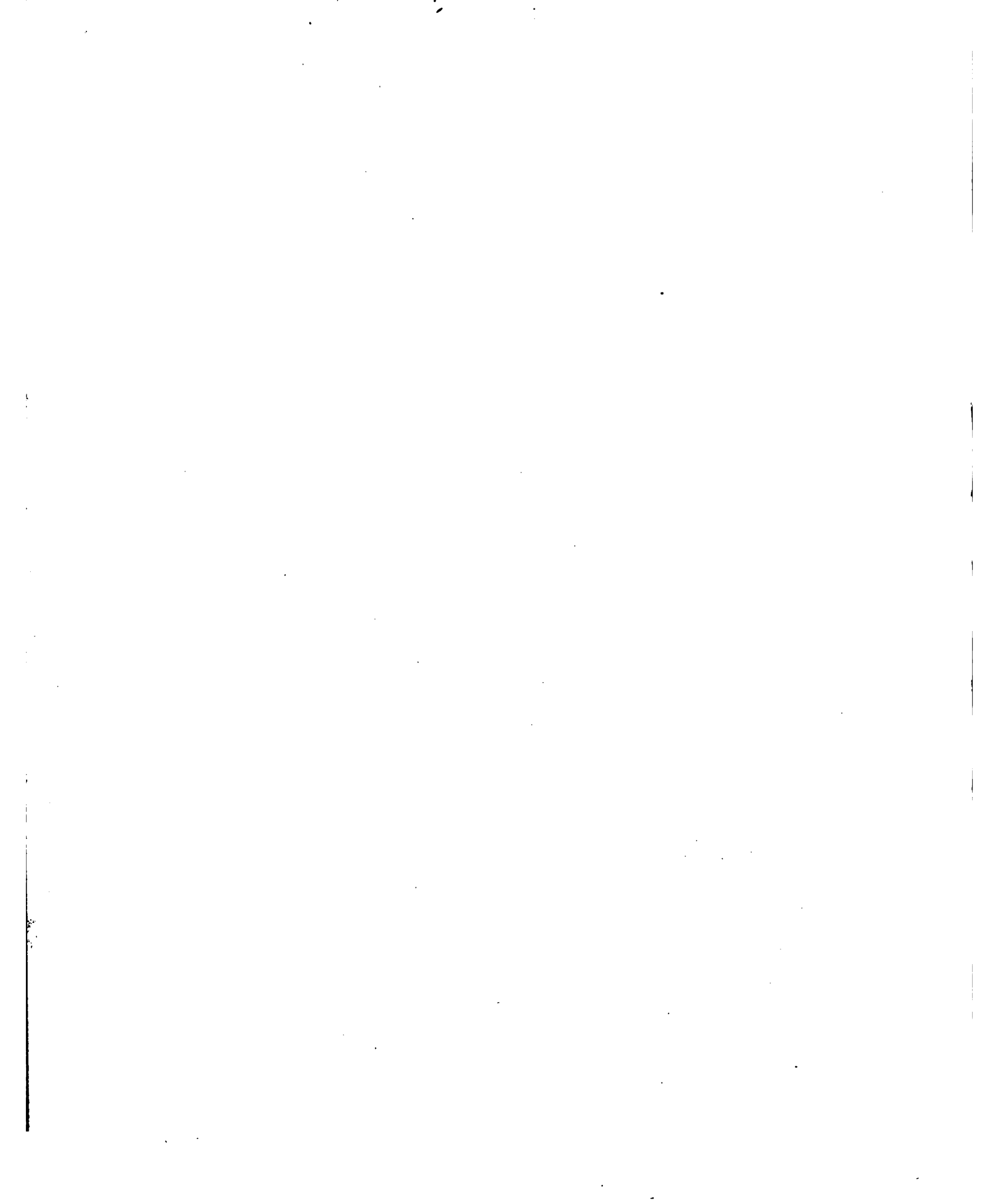
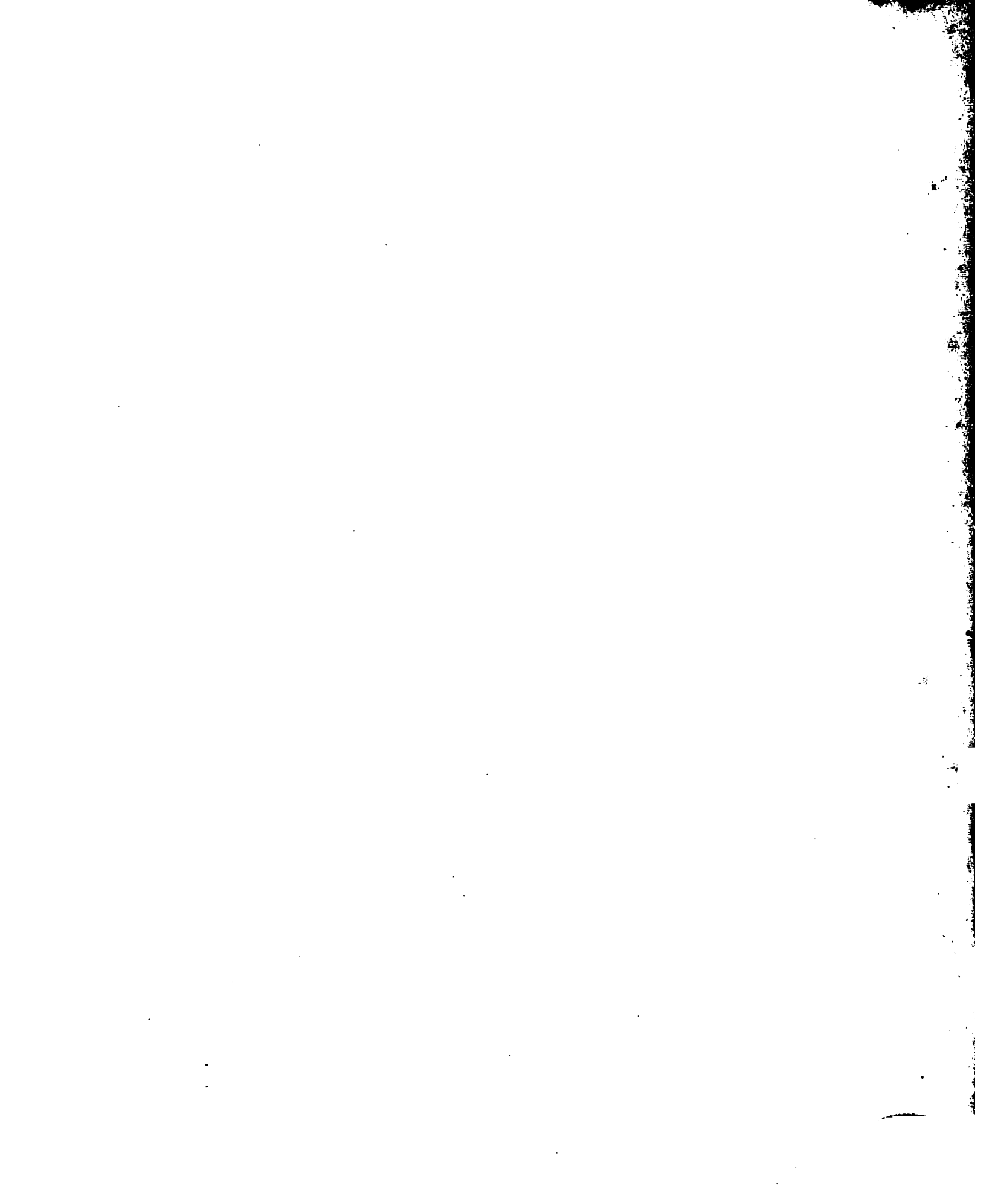


Fig. 45.

3 metres.

1 2 3 4 5 6 7 8 9 10 decim. 3 metres





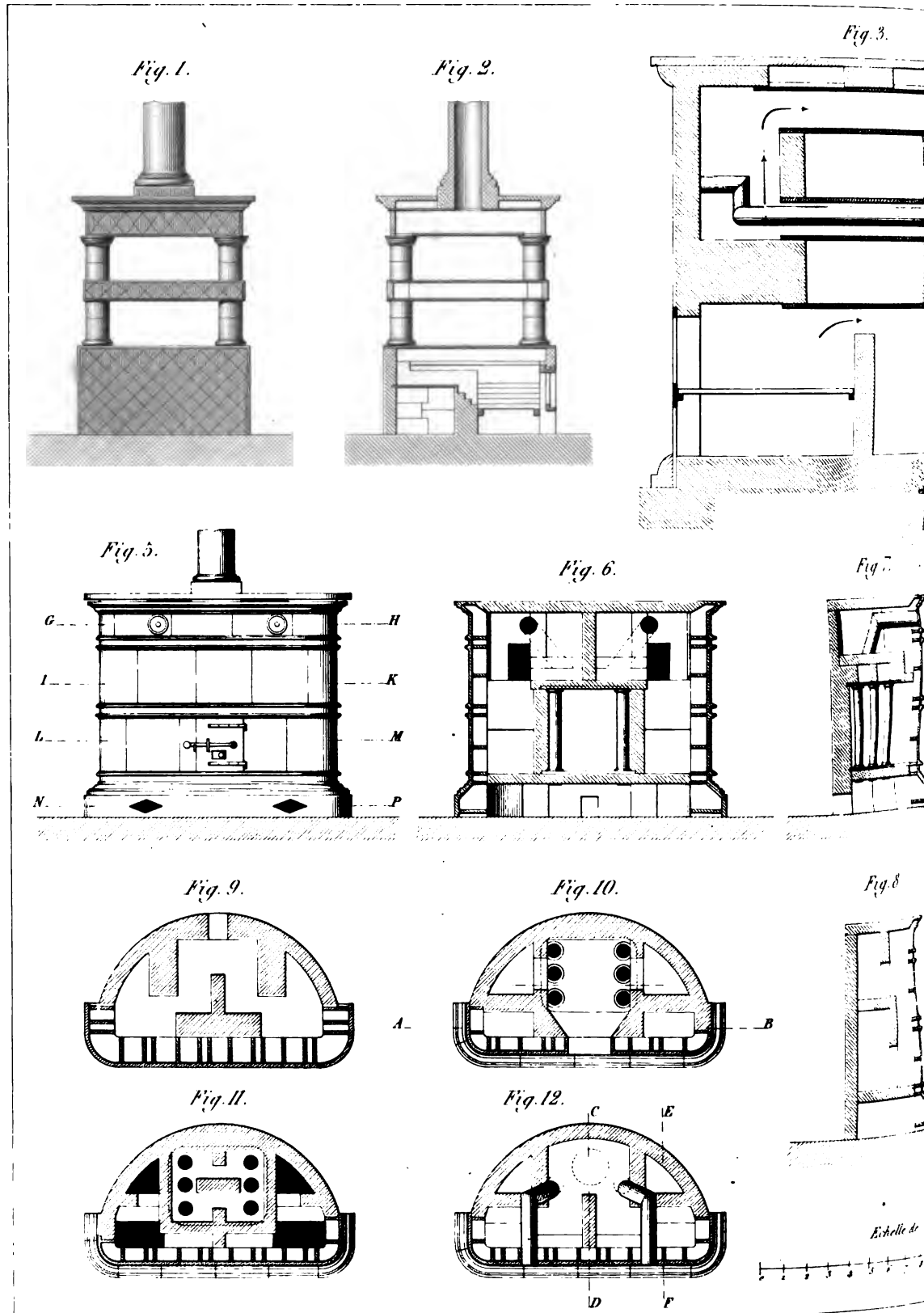


Fig. 4.

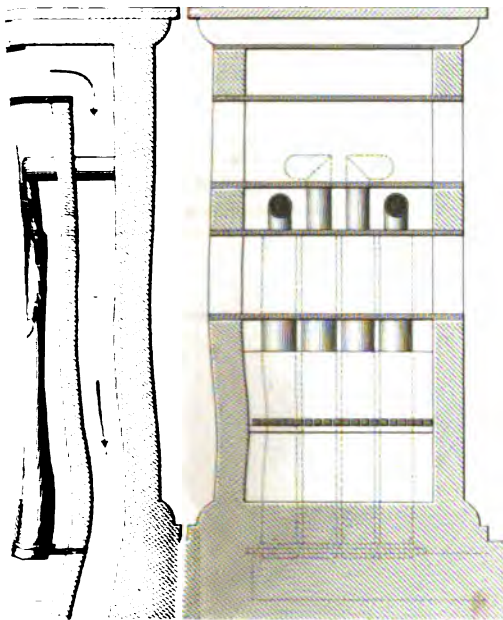


Fig. 21.

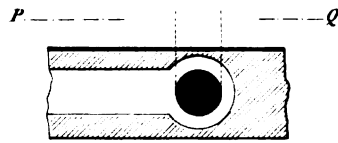


Fig. 19.



Fig. 22.

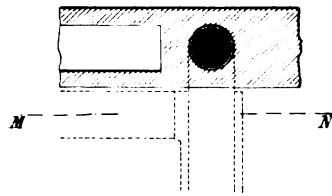


Fig. 20.

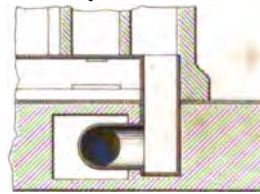


Fig. 13.

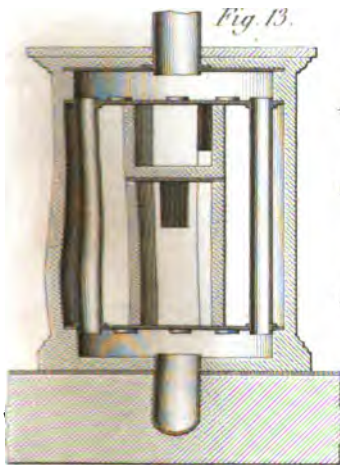


Fig. 14.

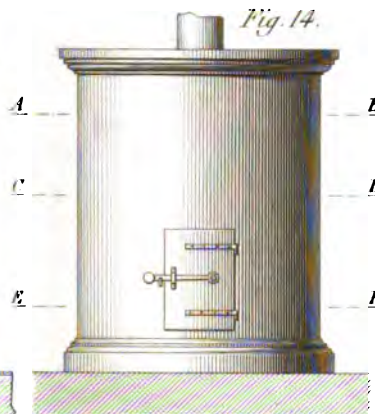


Fig. 15.

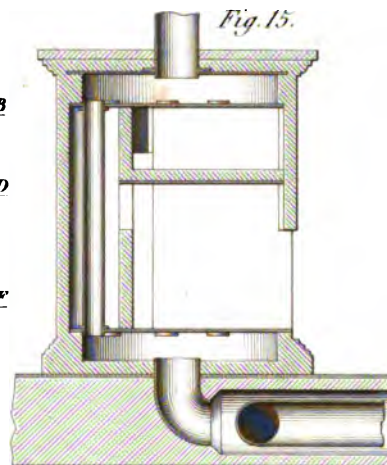


Fig. 16.

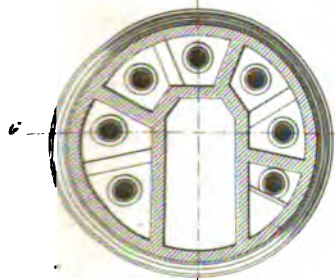


Fig. 17.

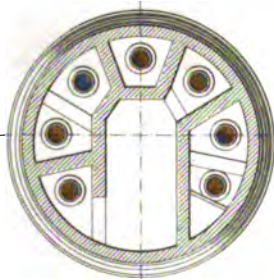
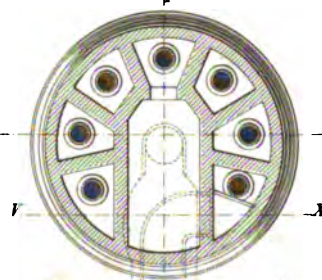


Fig. 18.



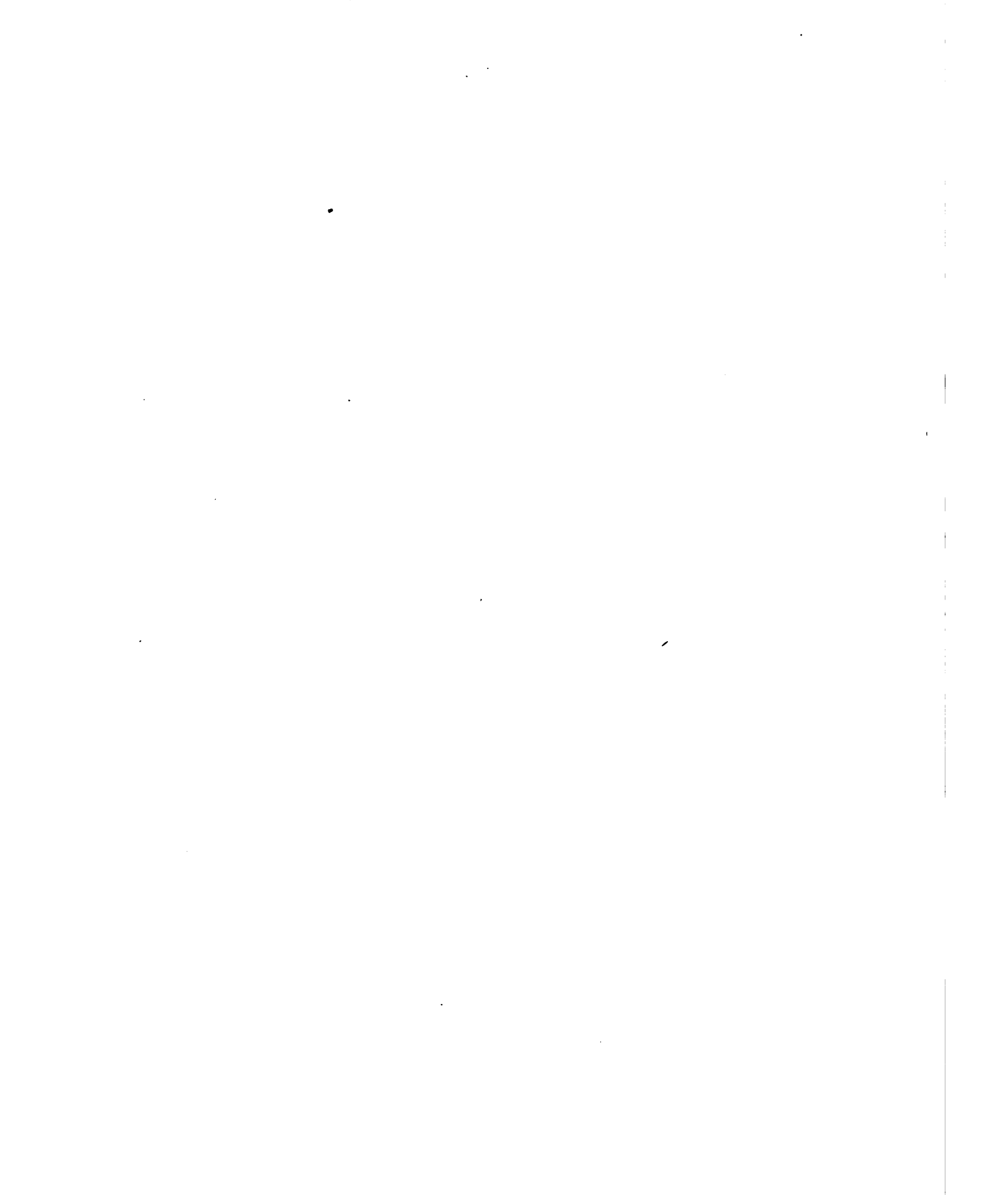
B, 4 10, 11 et 12

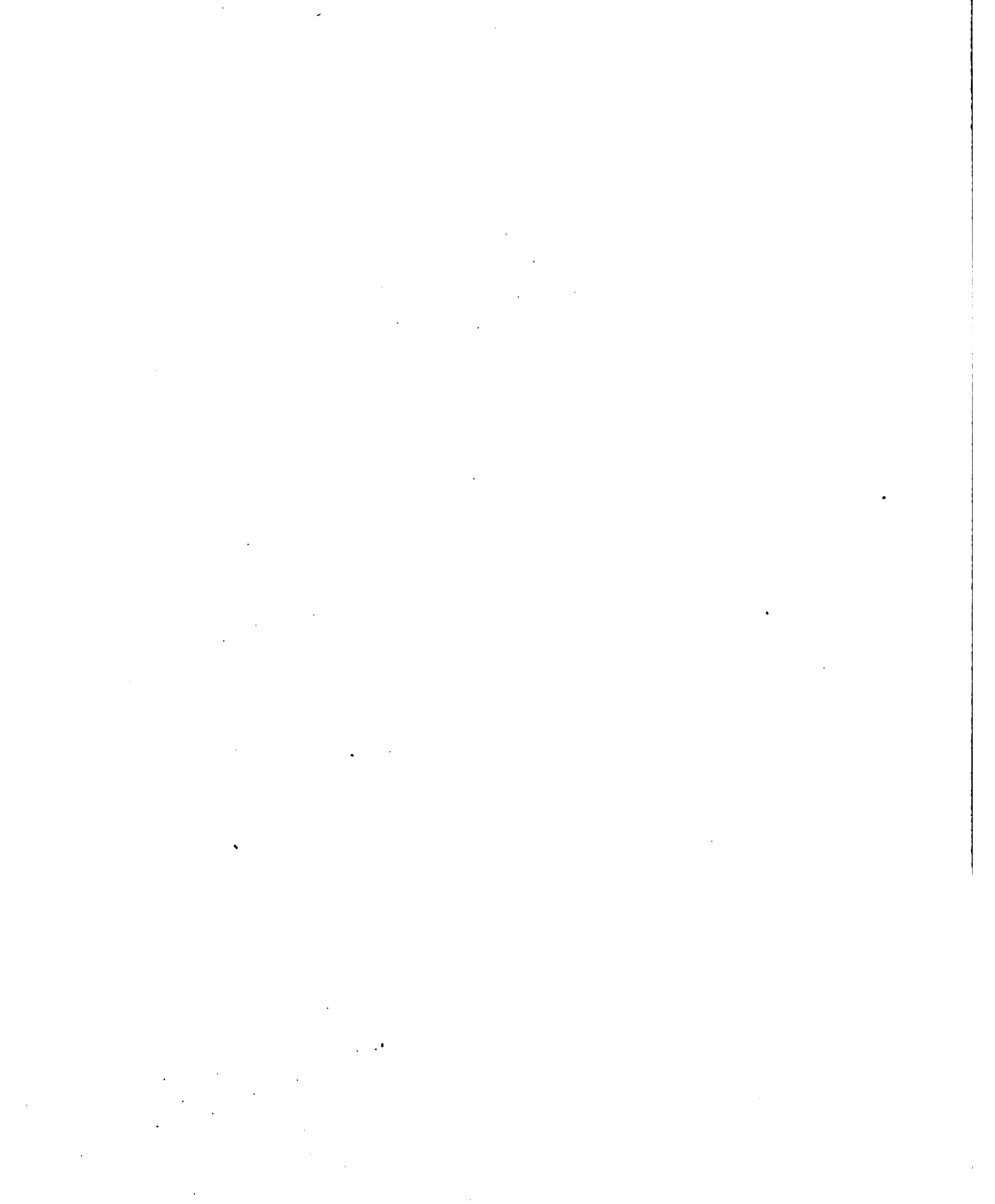
3 metres

Echelle des Fig. 13, 14, 15, 16, 17 et 18.

1 2 3 4 5 6 7 8 9 10 decimètres

3 metres





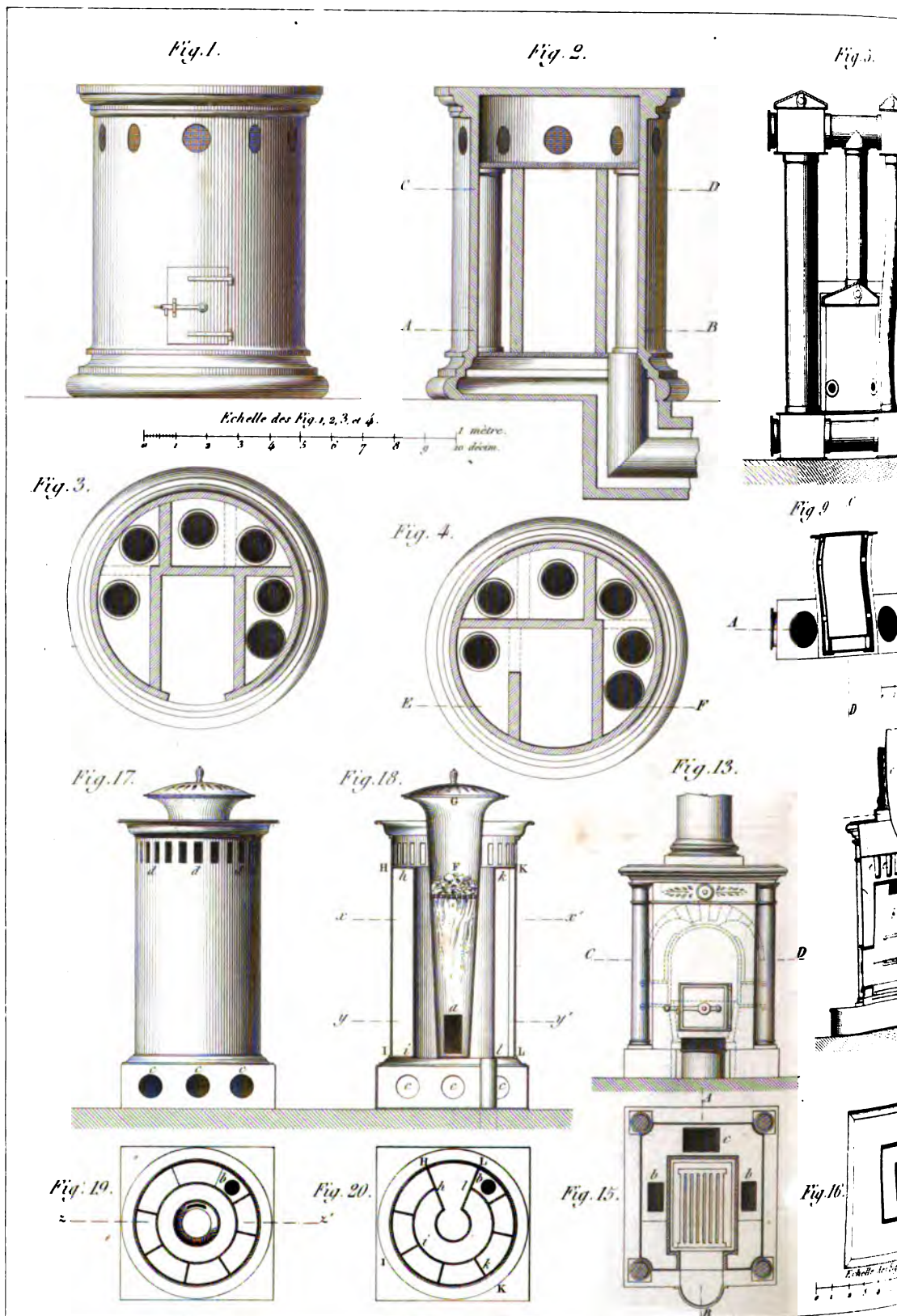


Fig. 6.

Fig. 7.

Fig. 8.

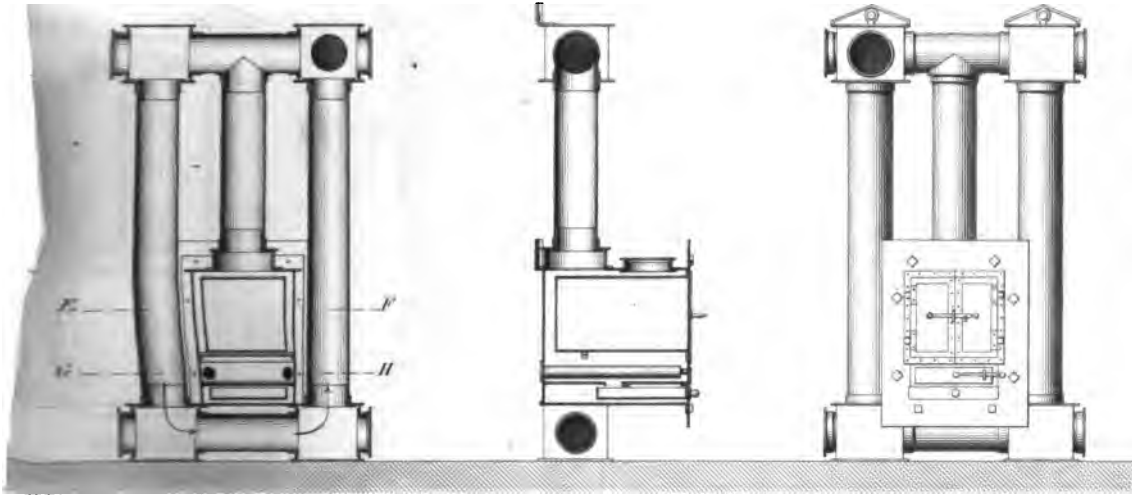


Fig. 10.

Fig. 11.

Fig. 12.

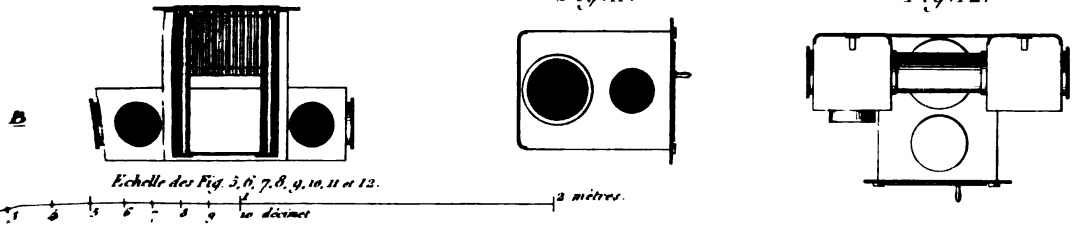
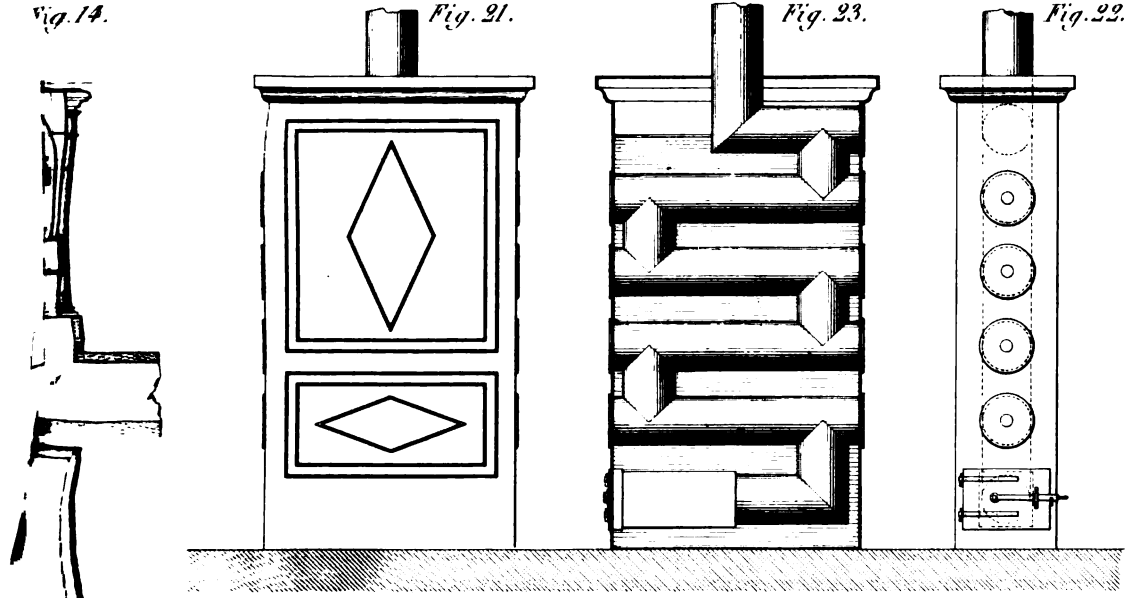


Fig. 14.

Fig. 21.

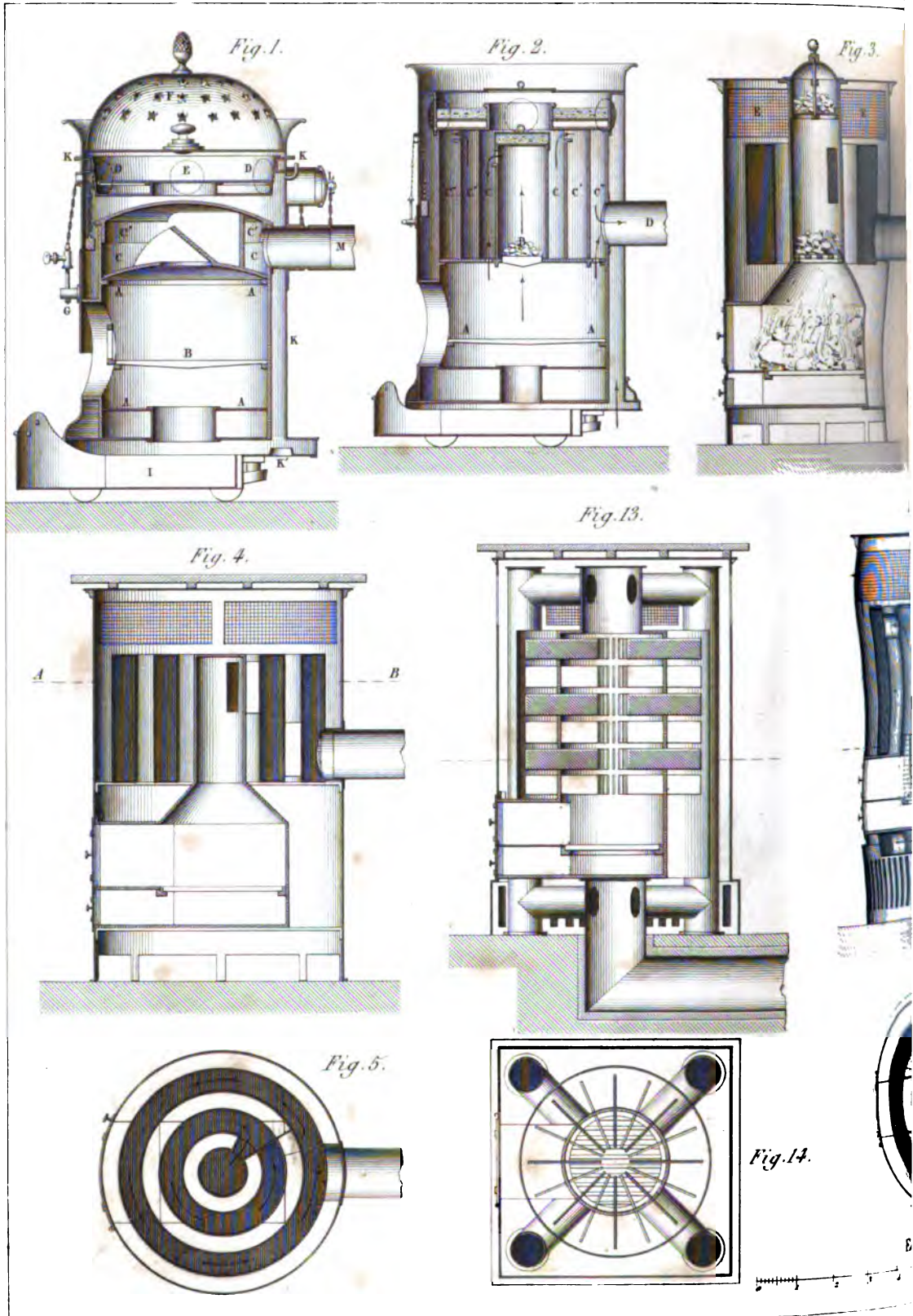
Fig. 23.

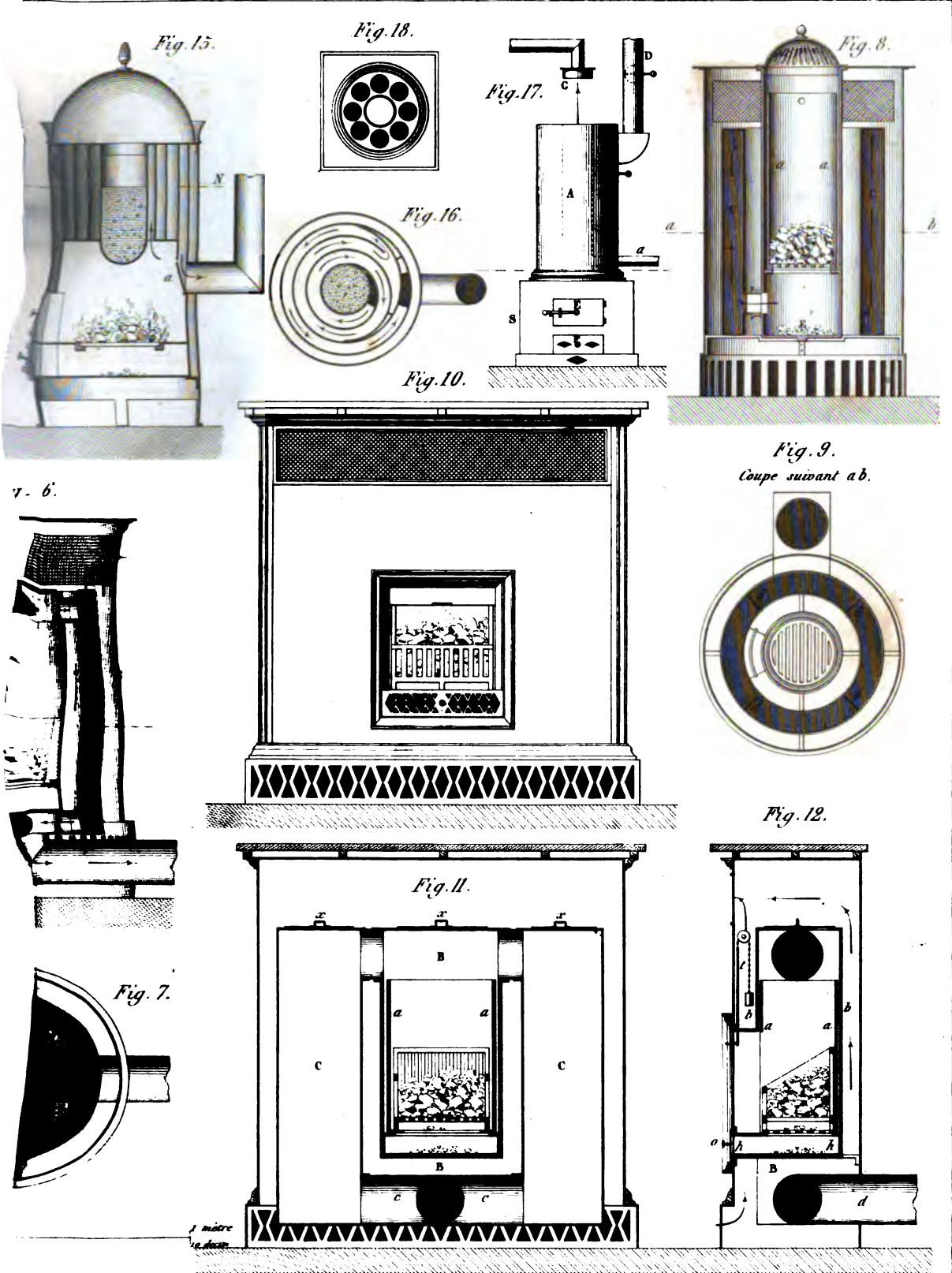
Fig. 22.





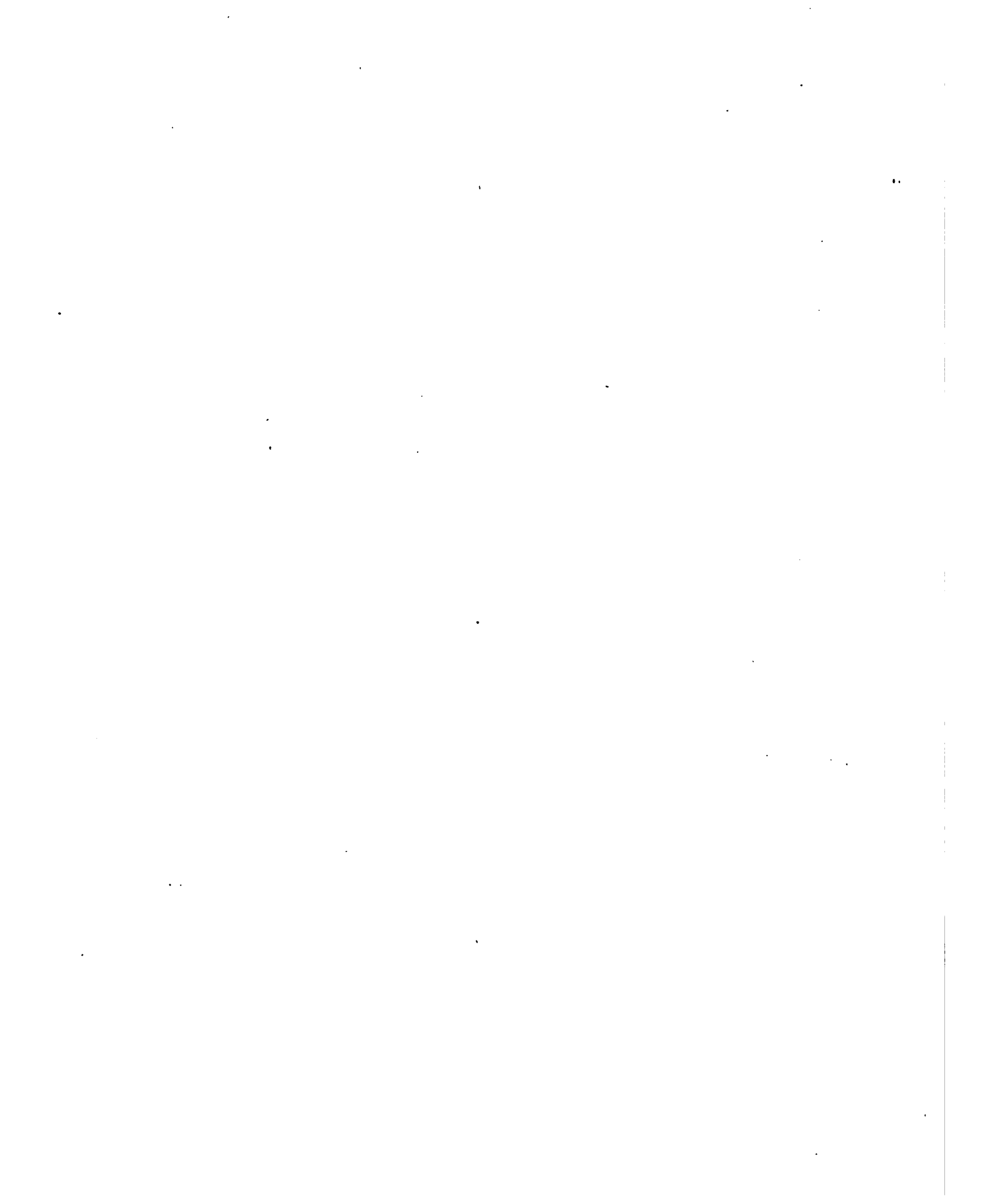






1 mètre
le dessin

dessiné par J. Petitcolin





TRAITÉ DE LA CHALEUR.

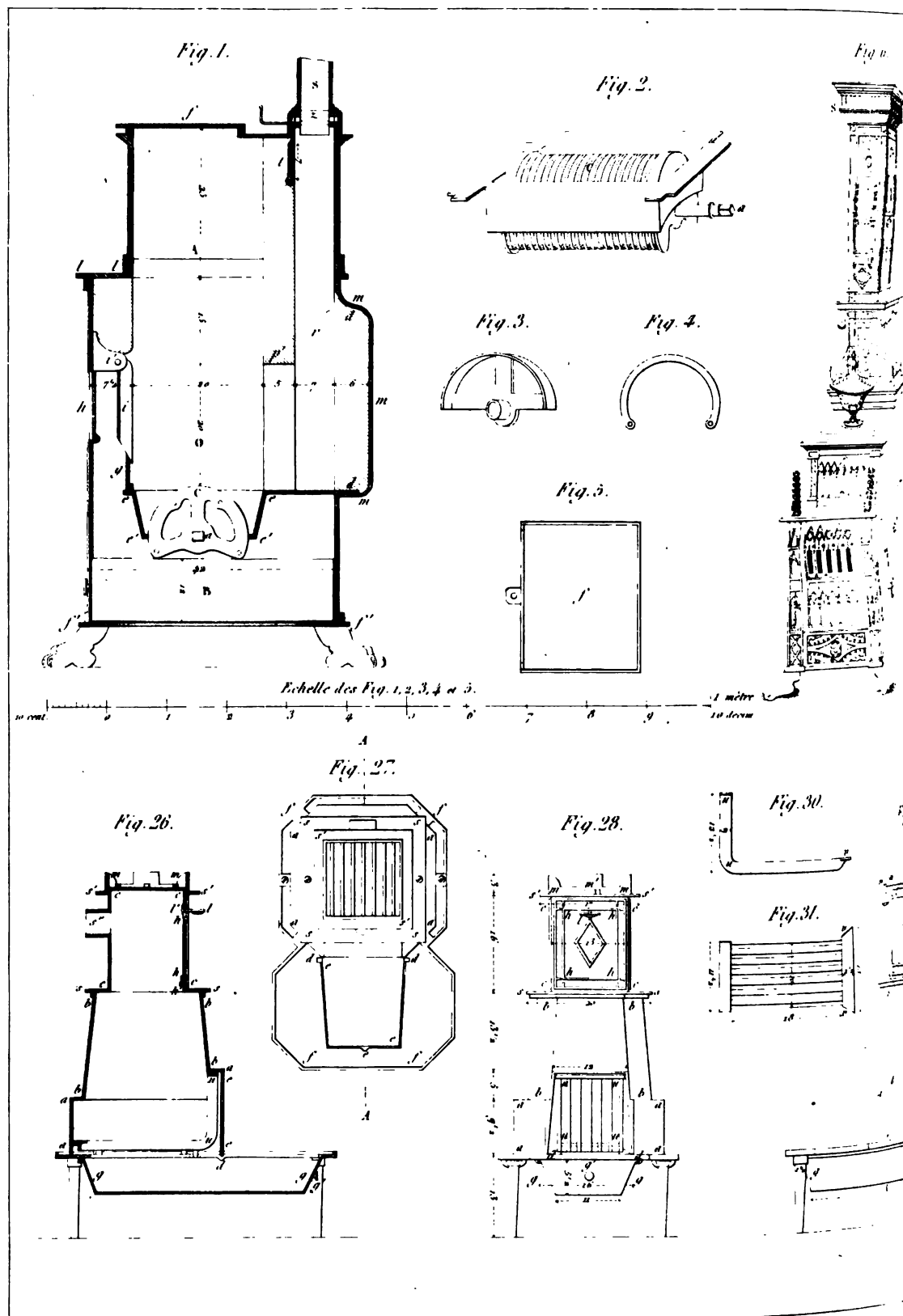


Fig. 9.

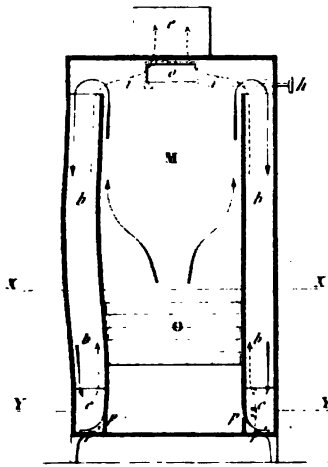


Fig. 10.

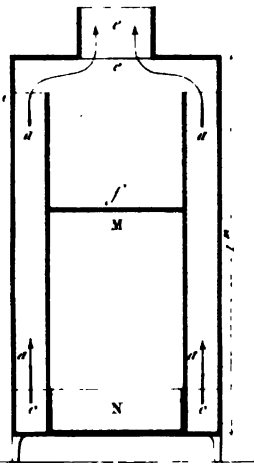


Fig. 11.

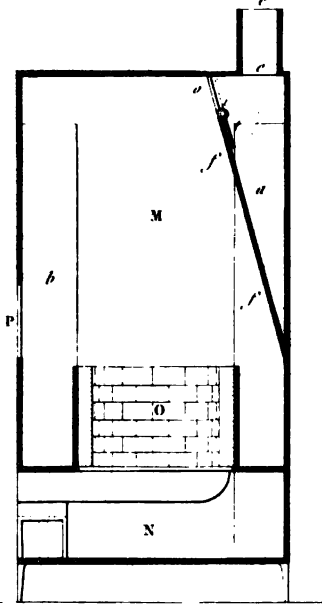


Fig. 7.

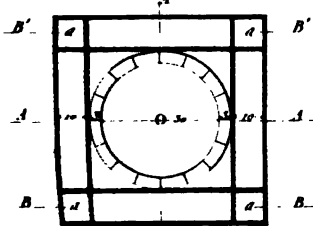


Fig. 8.

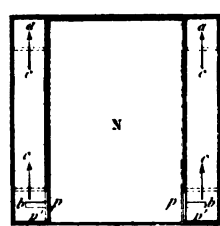


Fig. 13.

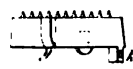


Fig. 12.

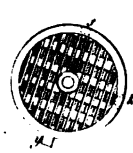


Fig. 14.

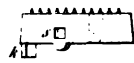


Fig. 18.

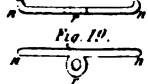


Fig. 19.



Fig. 20.



Fig. 16.

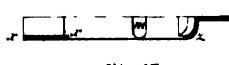


Fig. 17.

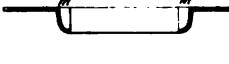


Fig. 15.

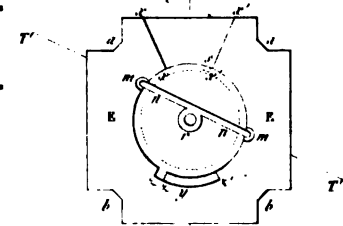


Fig. 23.



Fig. 24.



Fig. 25.



Fig. 32.

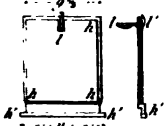


Fig. 33.

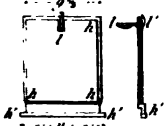


Fig. 21.



Fig. 34.

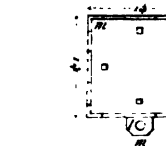


Fig. 35.



Fig. 36.

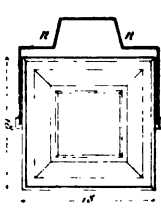
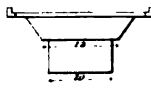


Fig. 37.

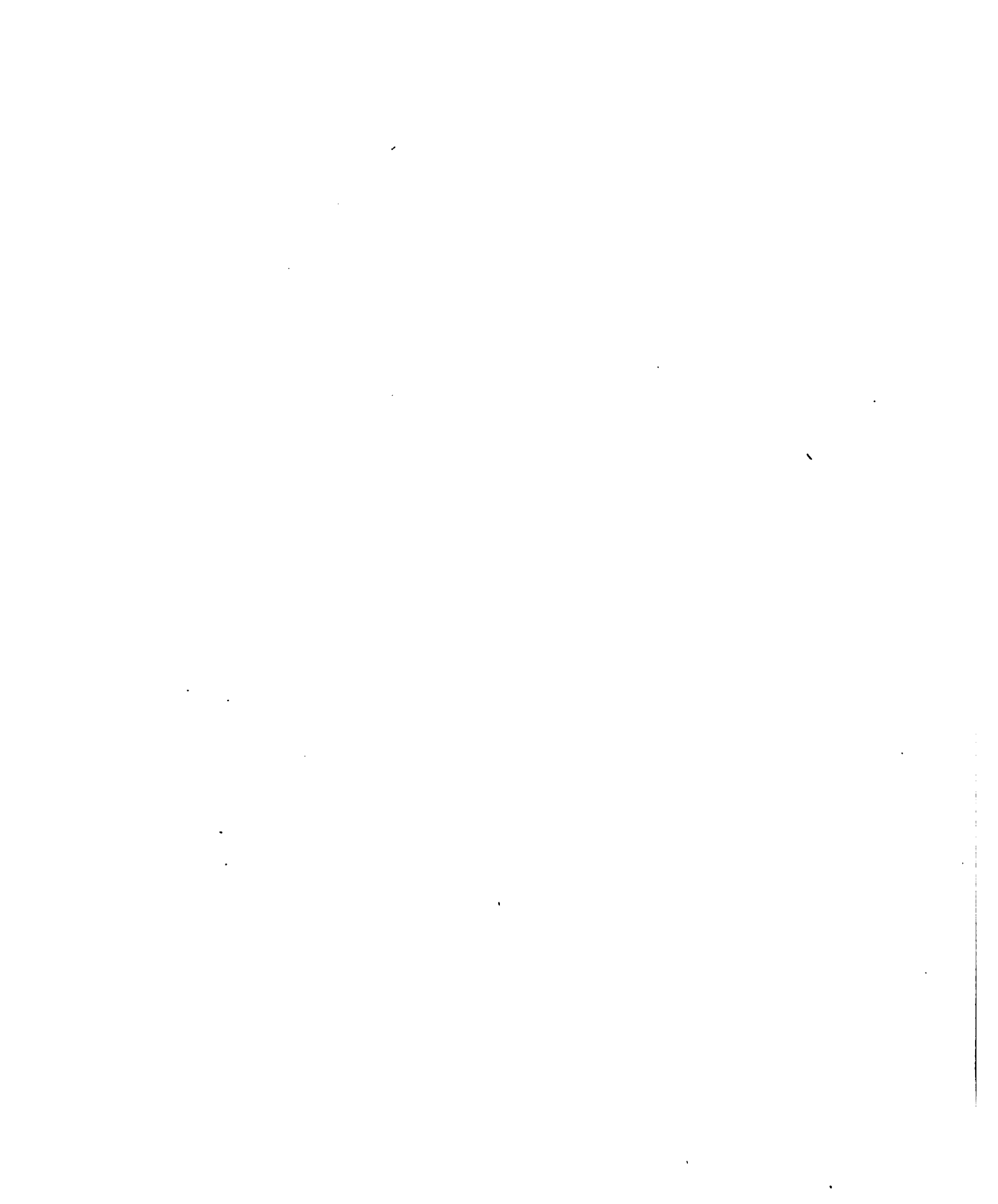


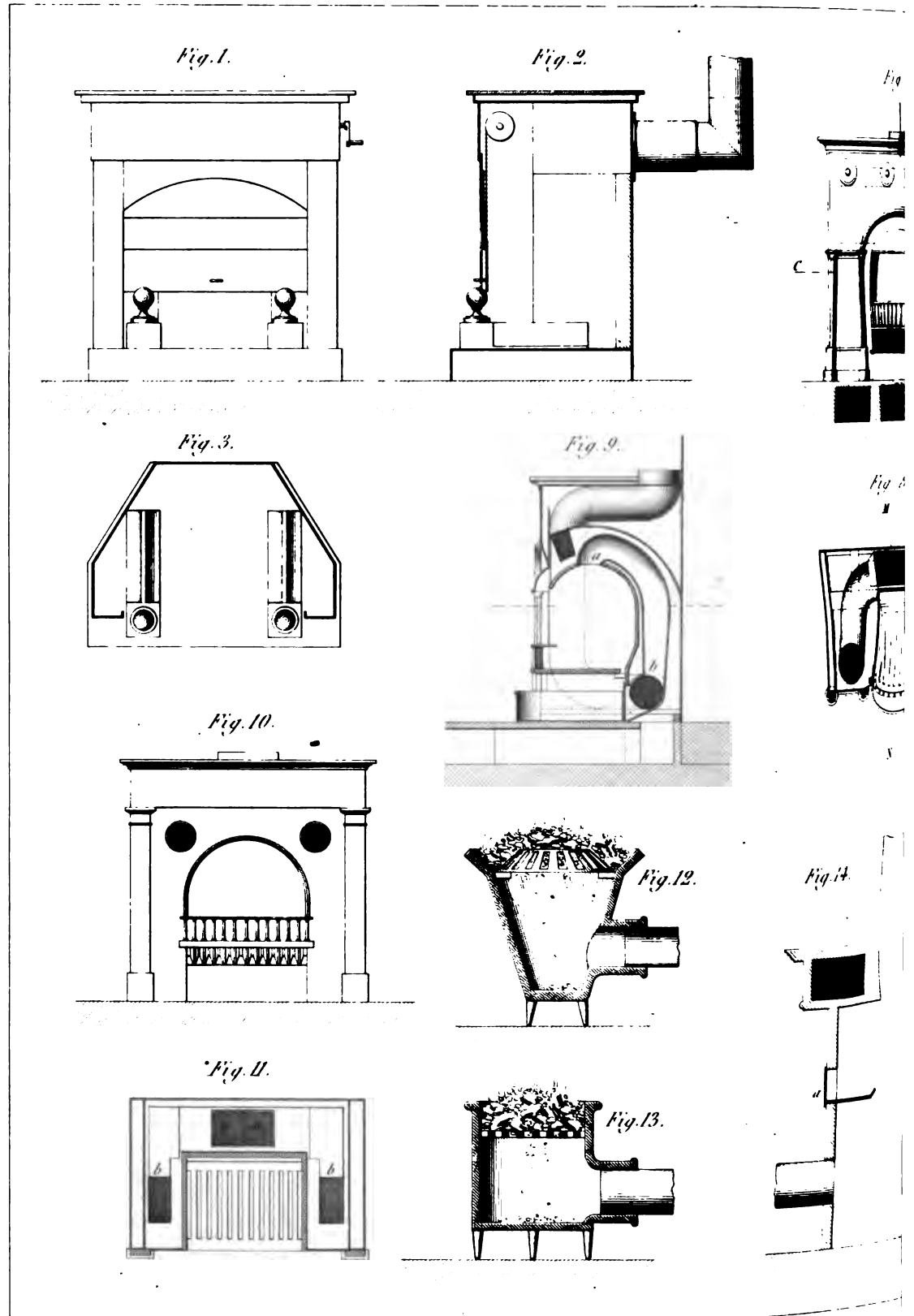
Echelle des Fig. 7, 8, 9, 10, 12, 13, 14, 15, 16, 17, 18, 19, 20, 21, 22, 23, 24 et 25.

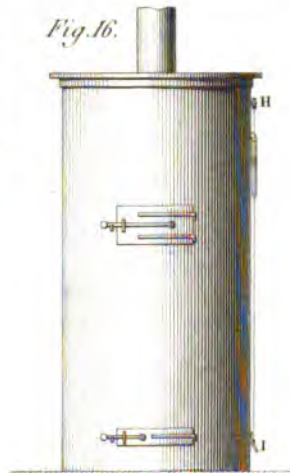
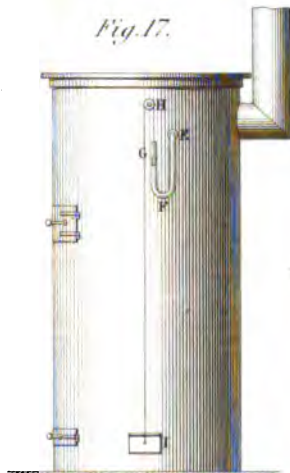
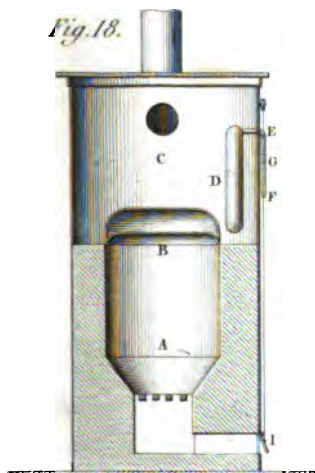
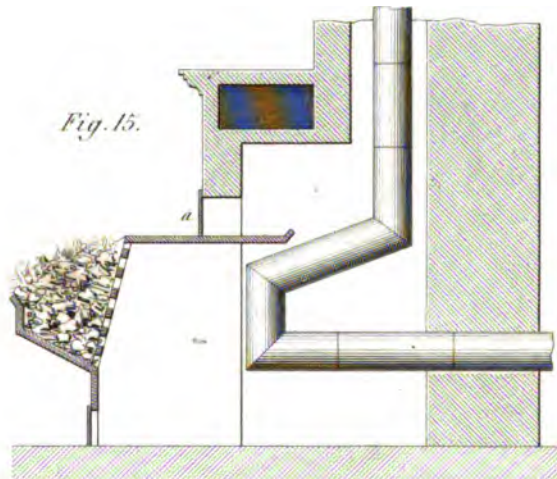
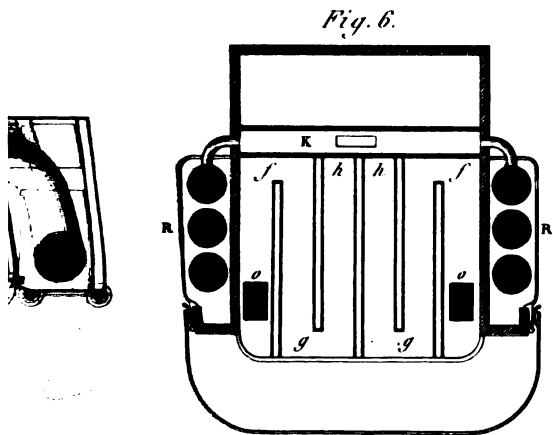
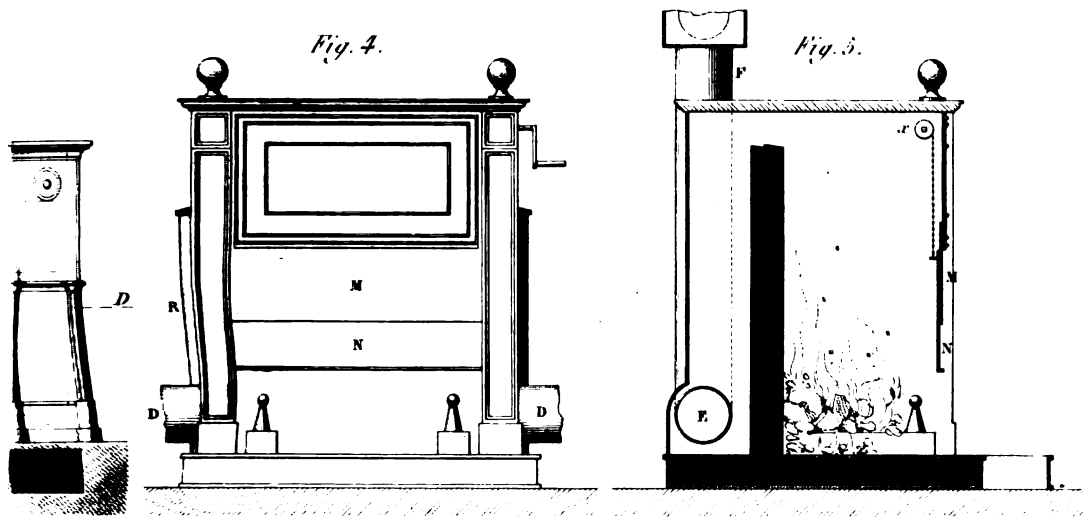
0 1 2 3 4 5 6 7 8 9 10 mètres

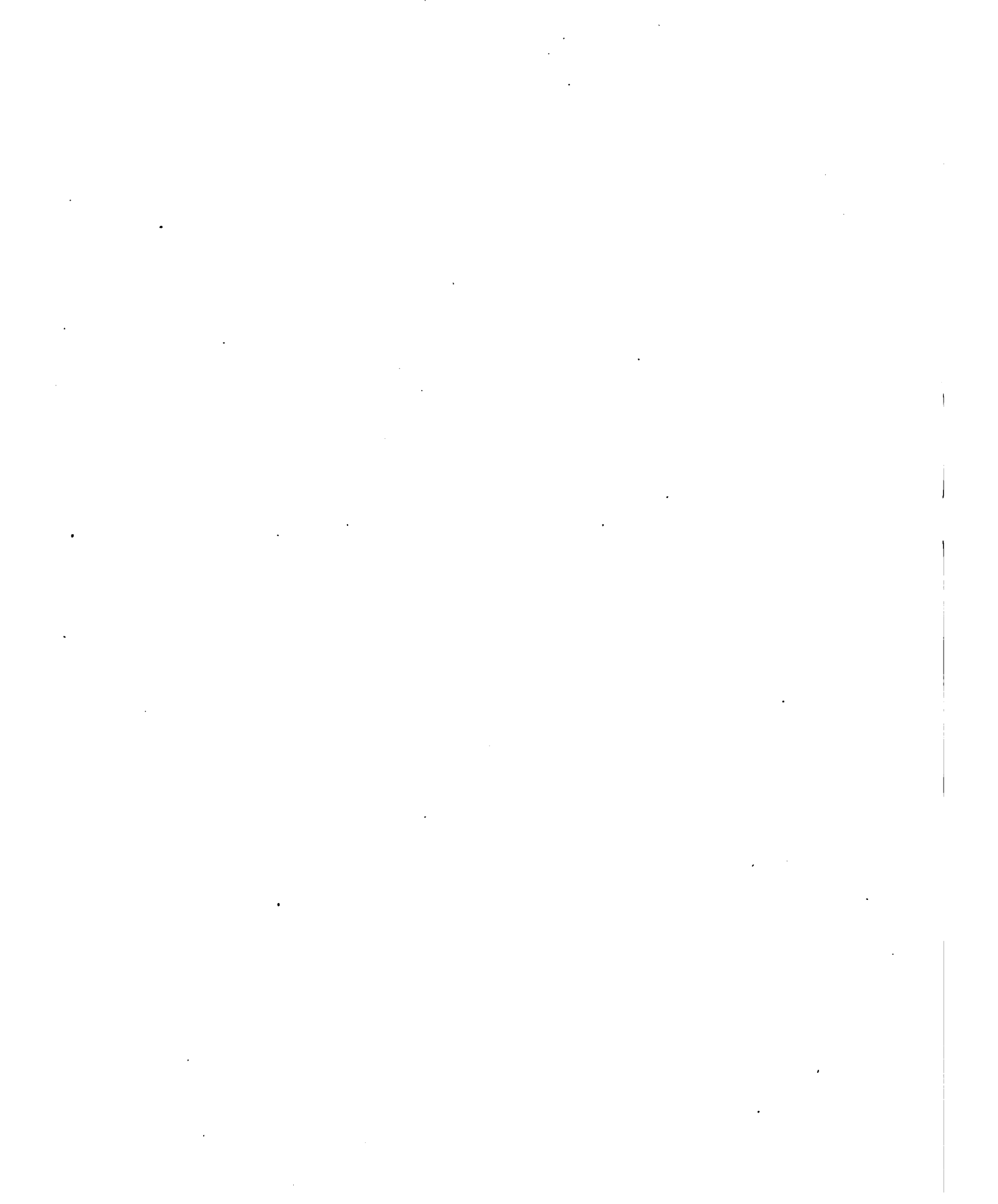
Echelle des Fig. 26, 27, 28, 29, 30, 31, 32, 33, 34, 35 et 37.

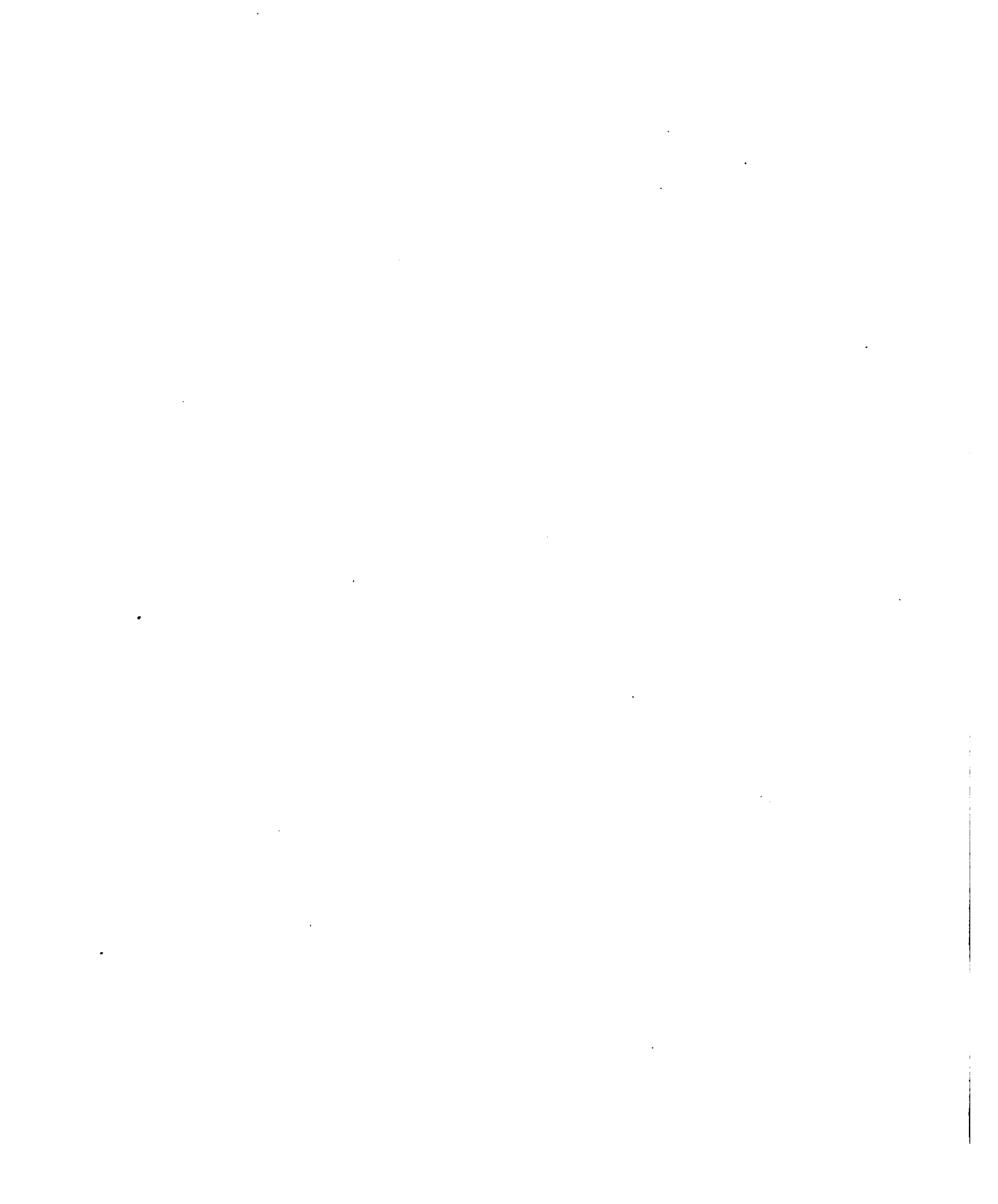
0 1 2 3 4 5 6 7 8 9 10 mètres











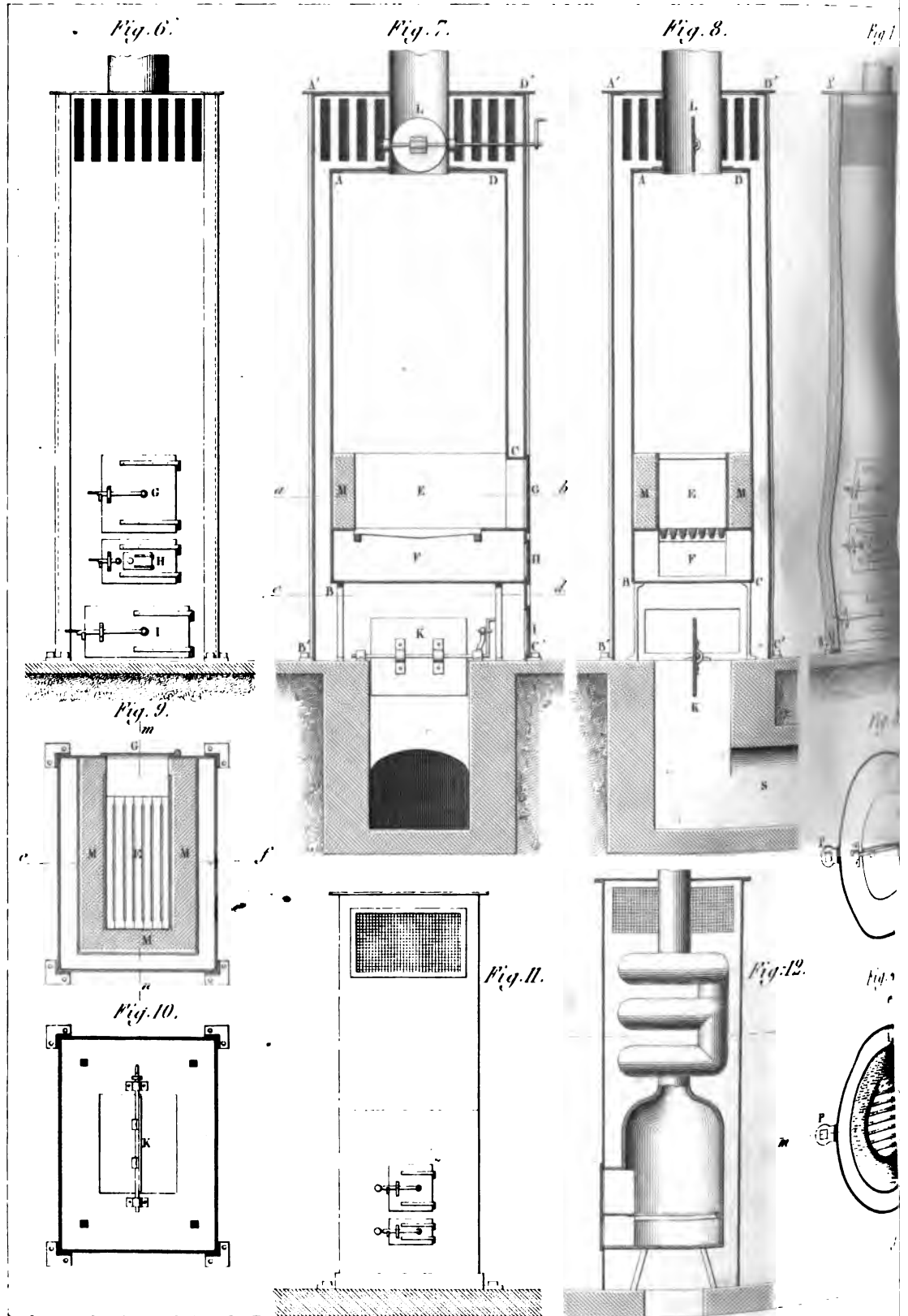


Fig. 2.

Fig. 3.

Fig. 16.

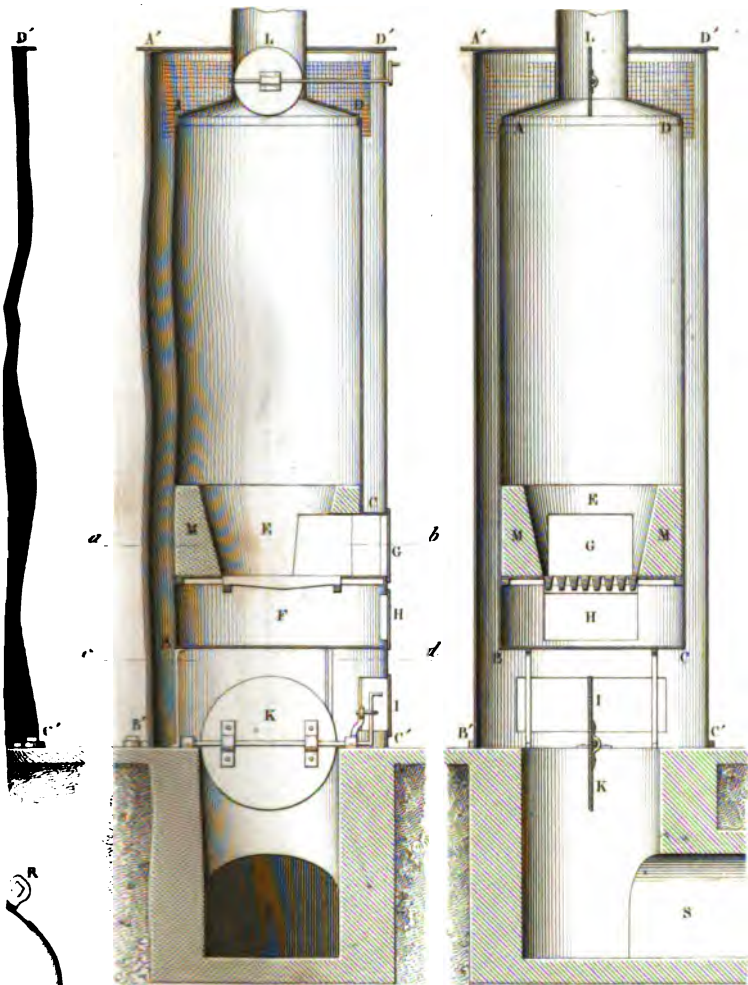


Fig. 17.



Fig. 18.

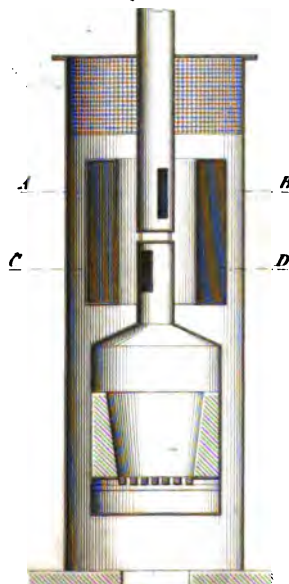


Fig. 15.

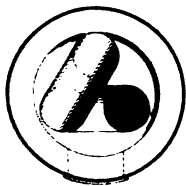


Fig. 13.

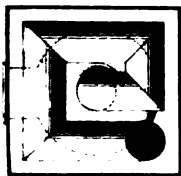
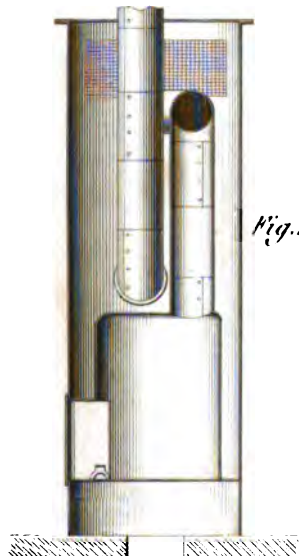


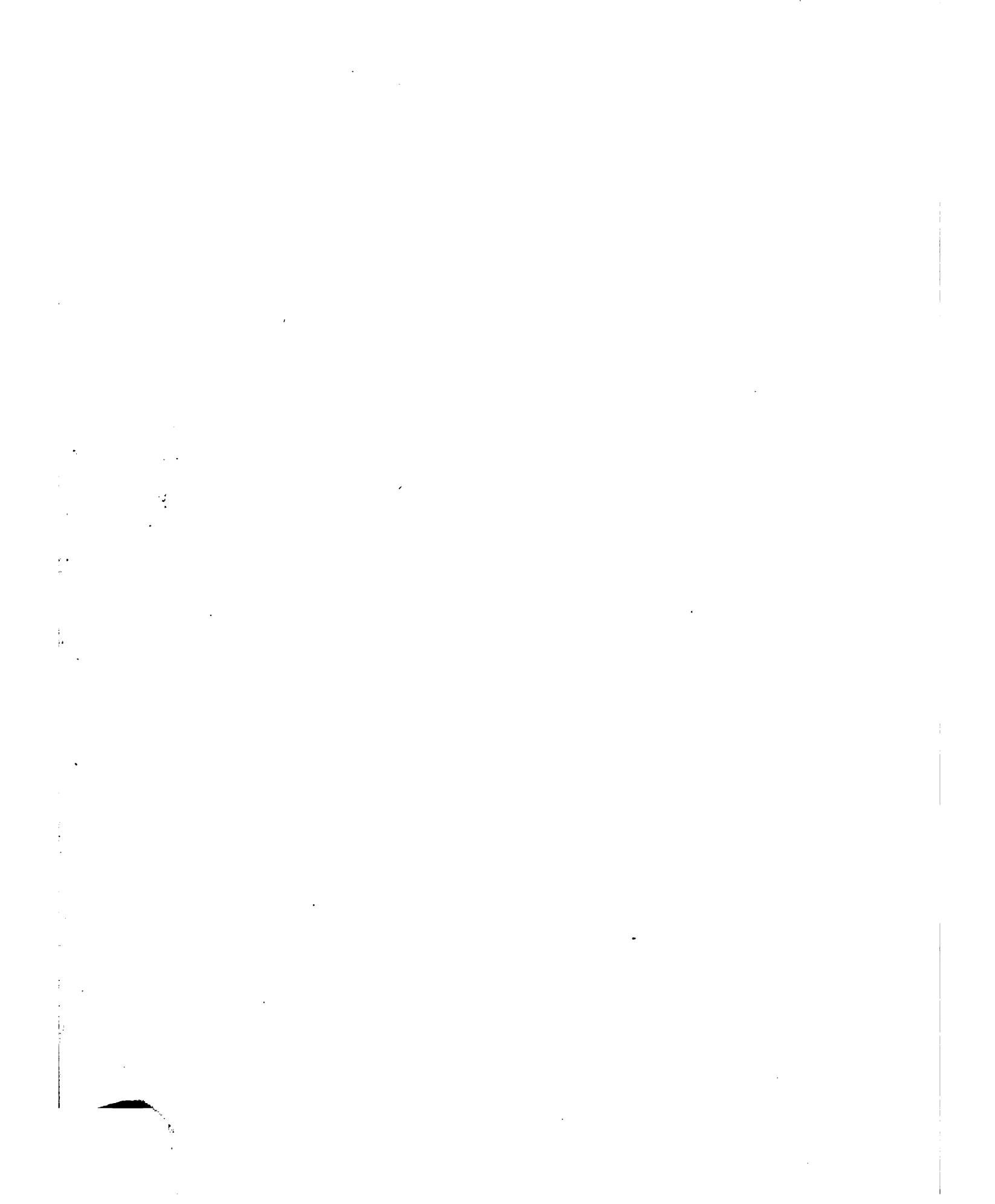
Fig. 19.

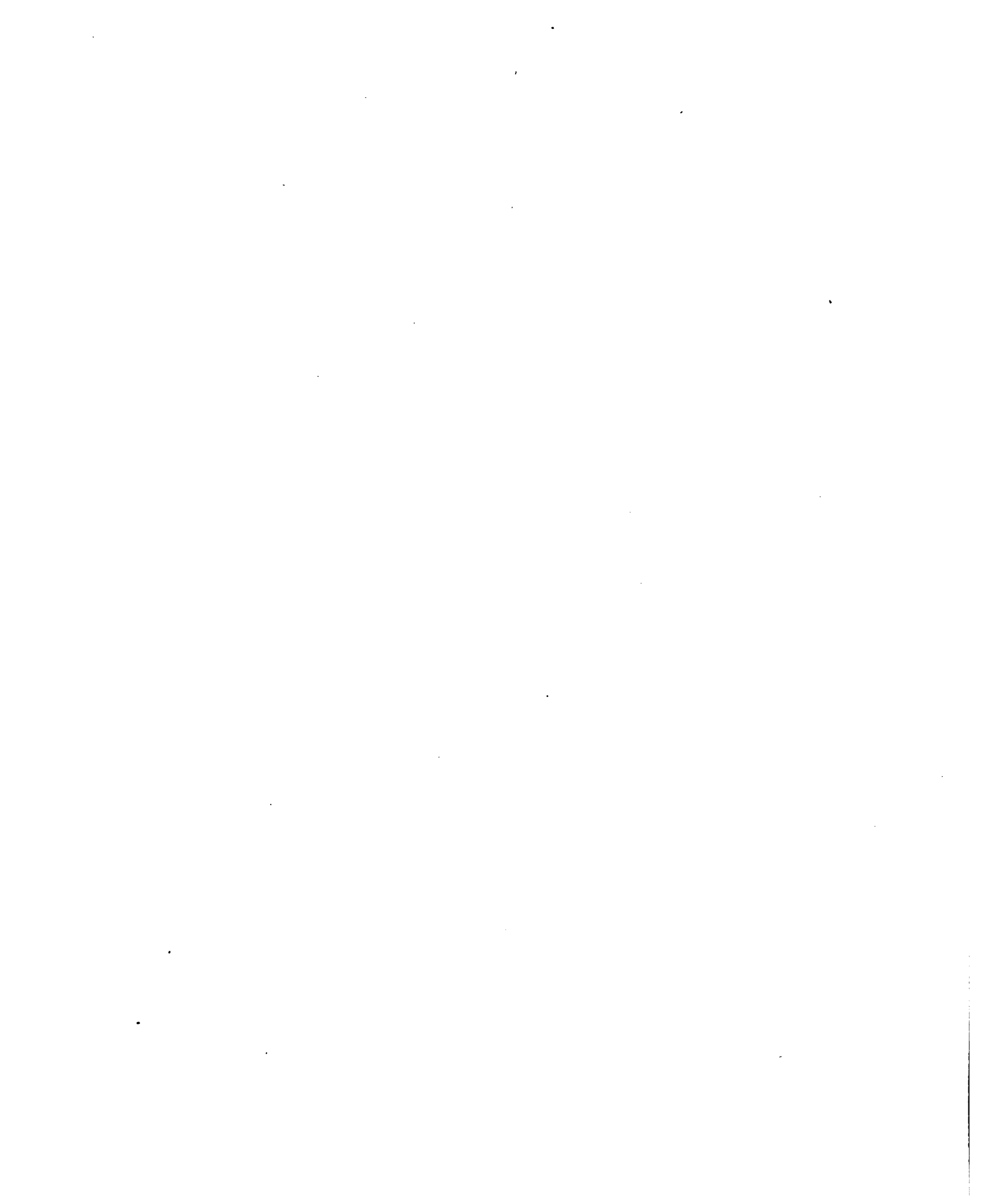


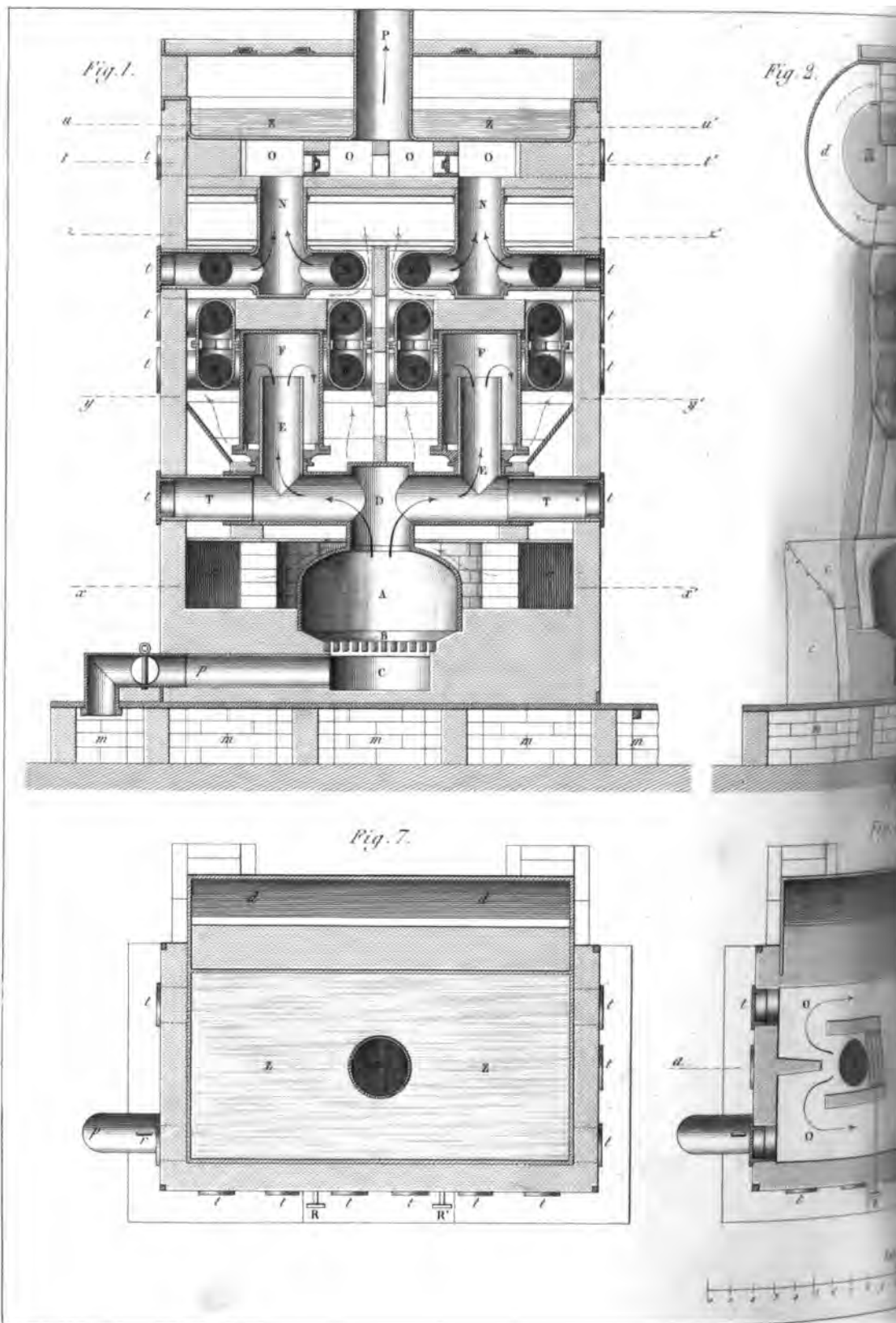
Fig. 14.

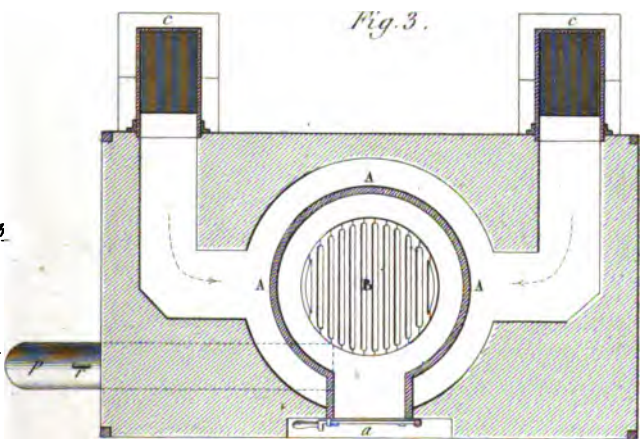
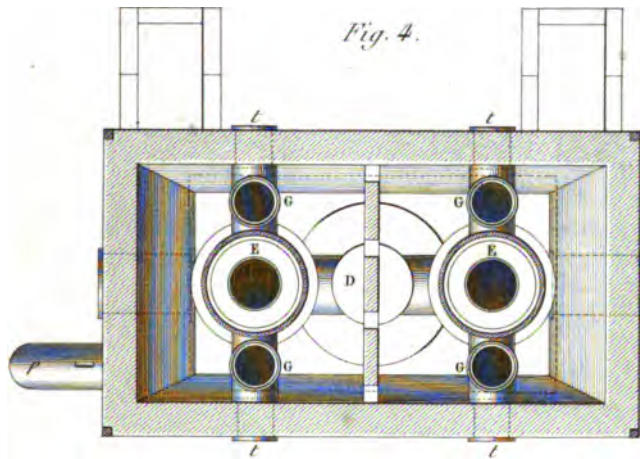
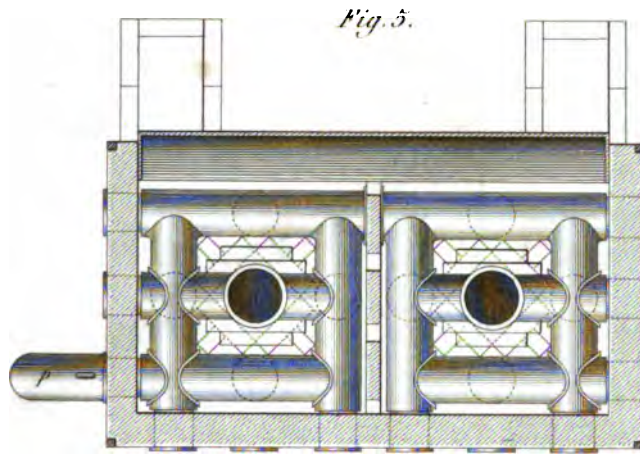
Fig. 20.



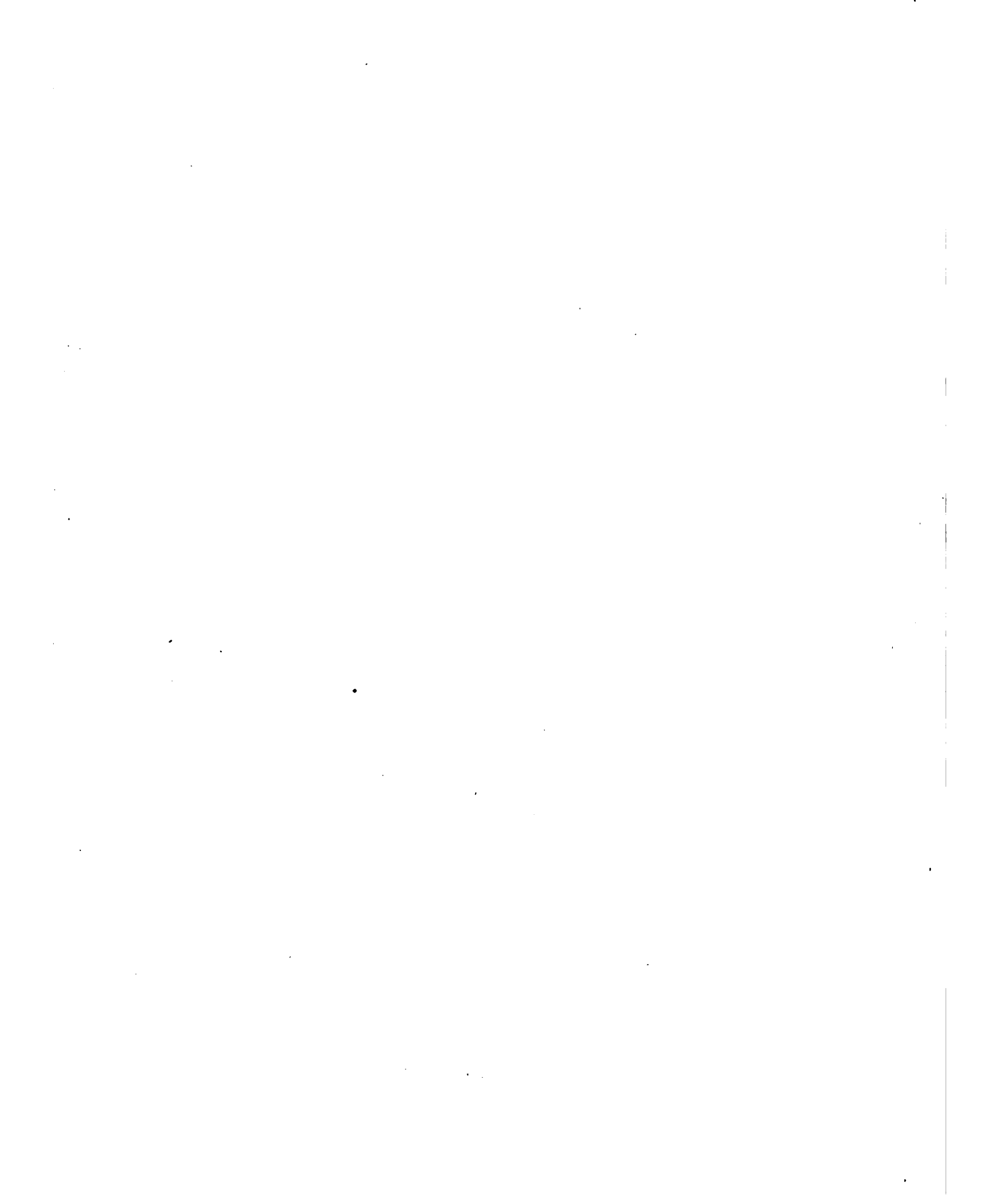


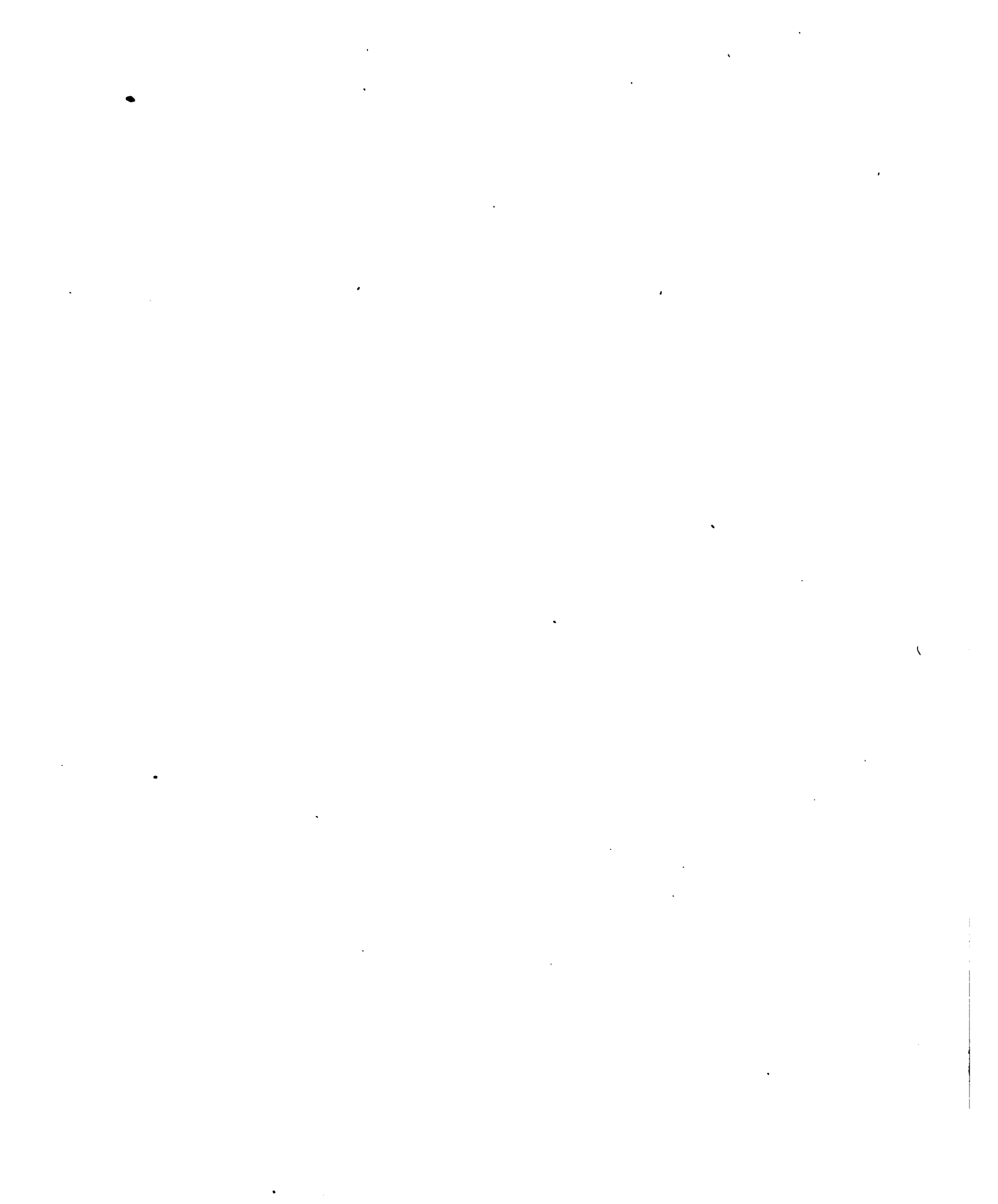


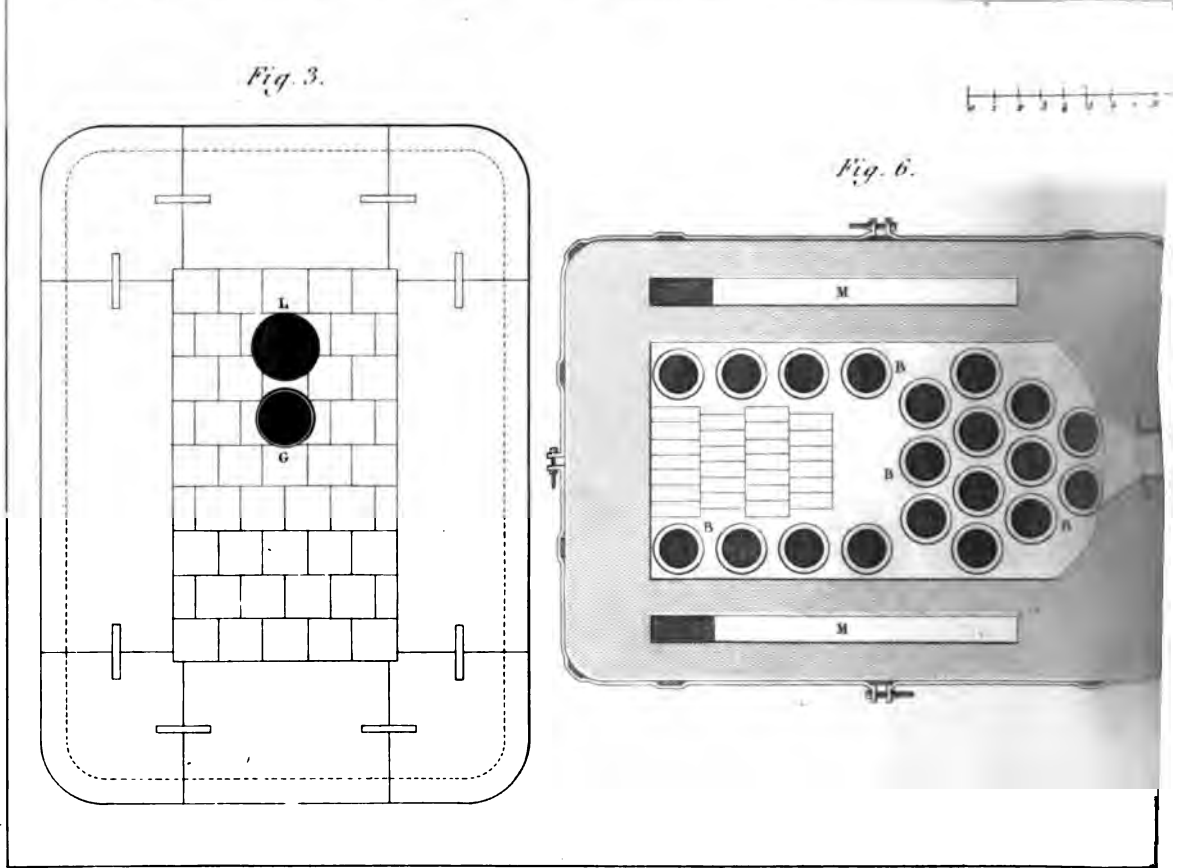
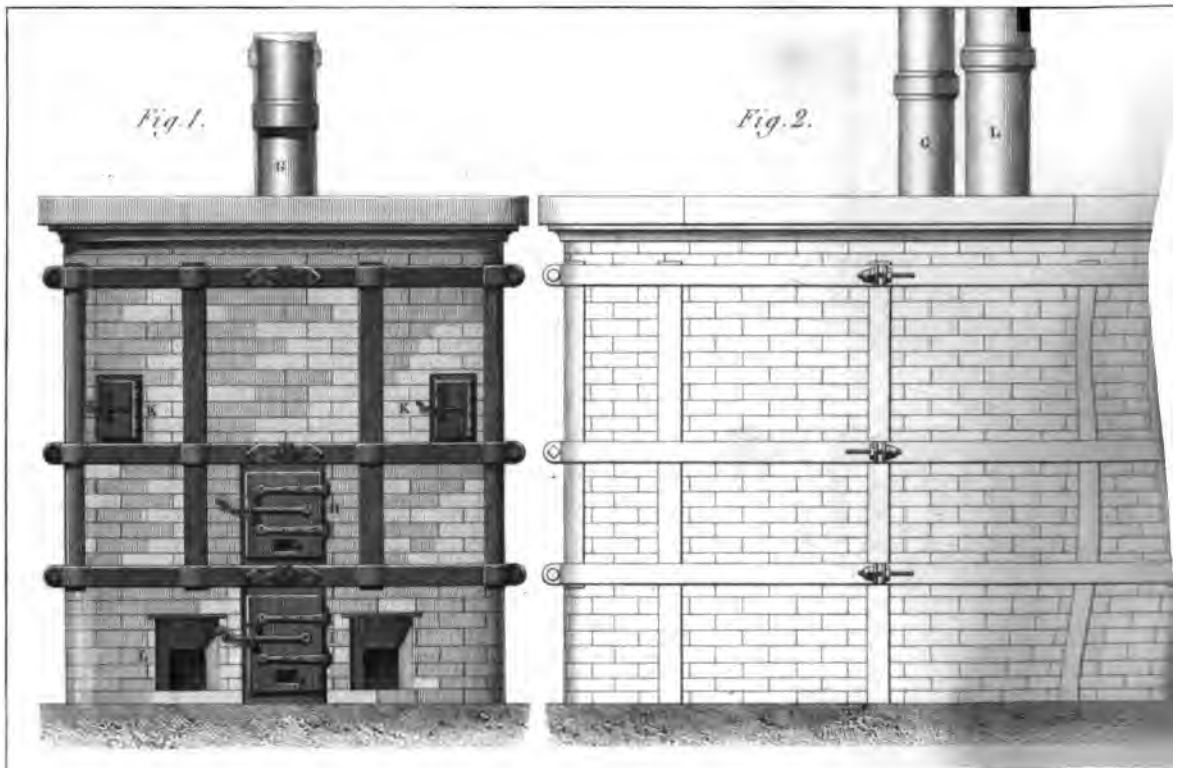


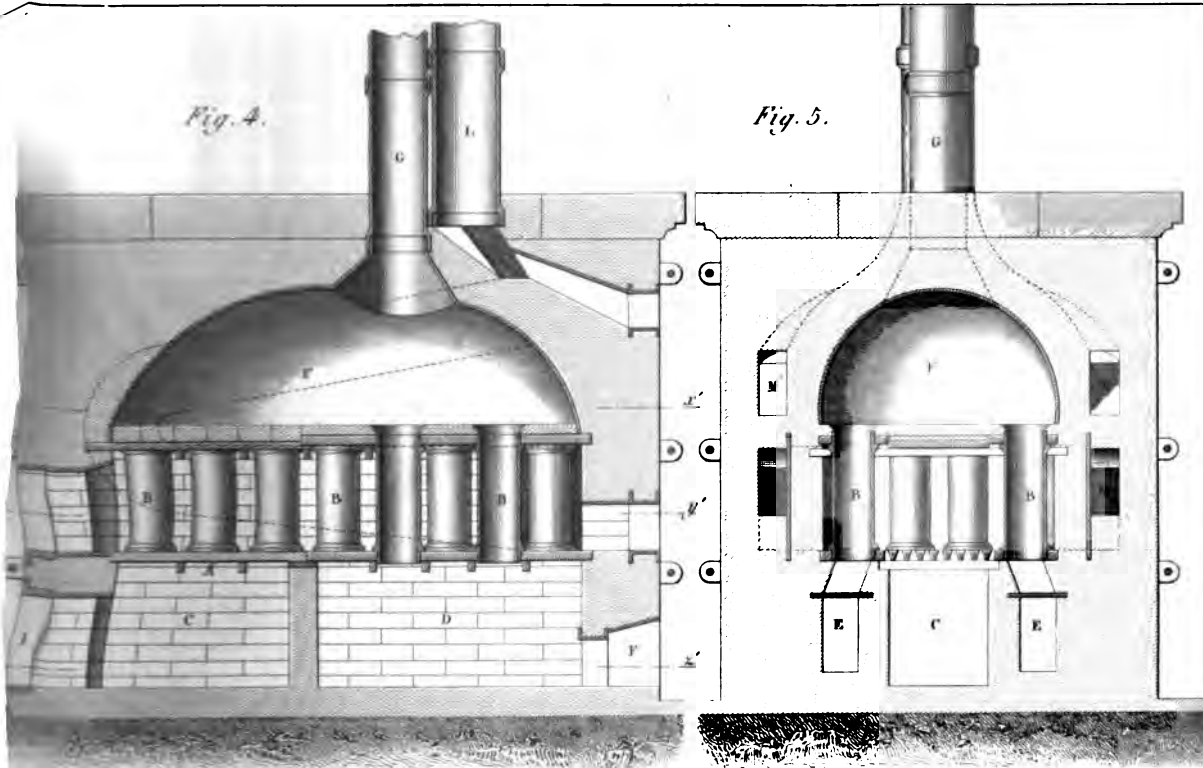


2 mètres.

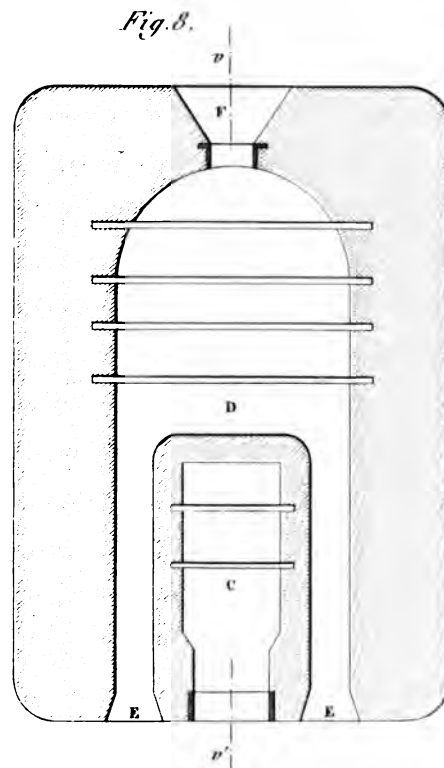
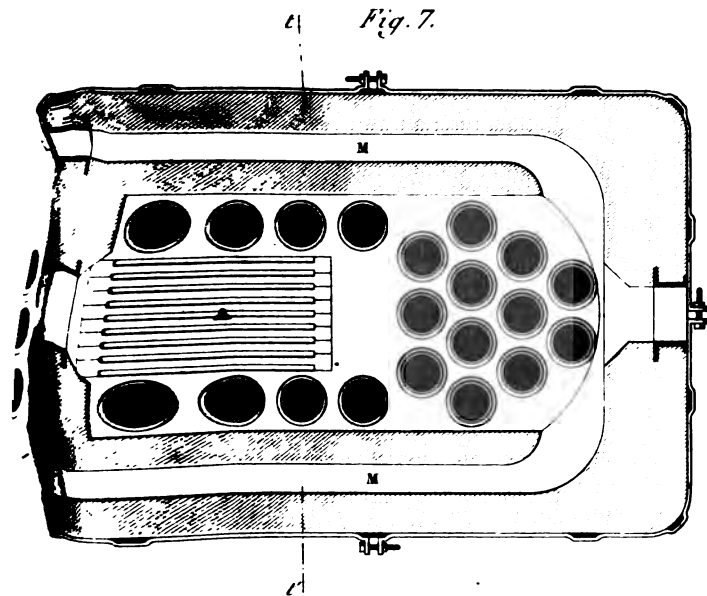


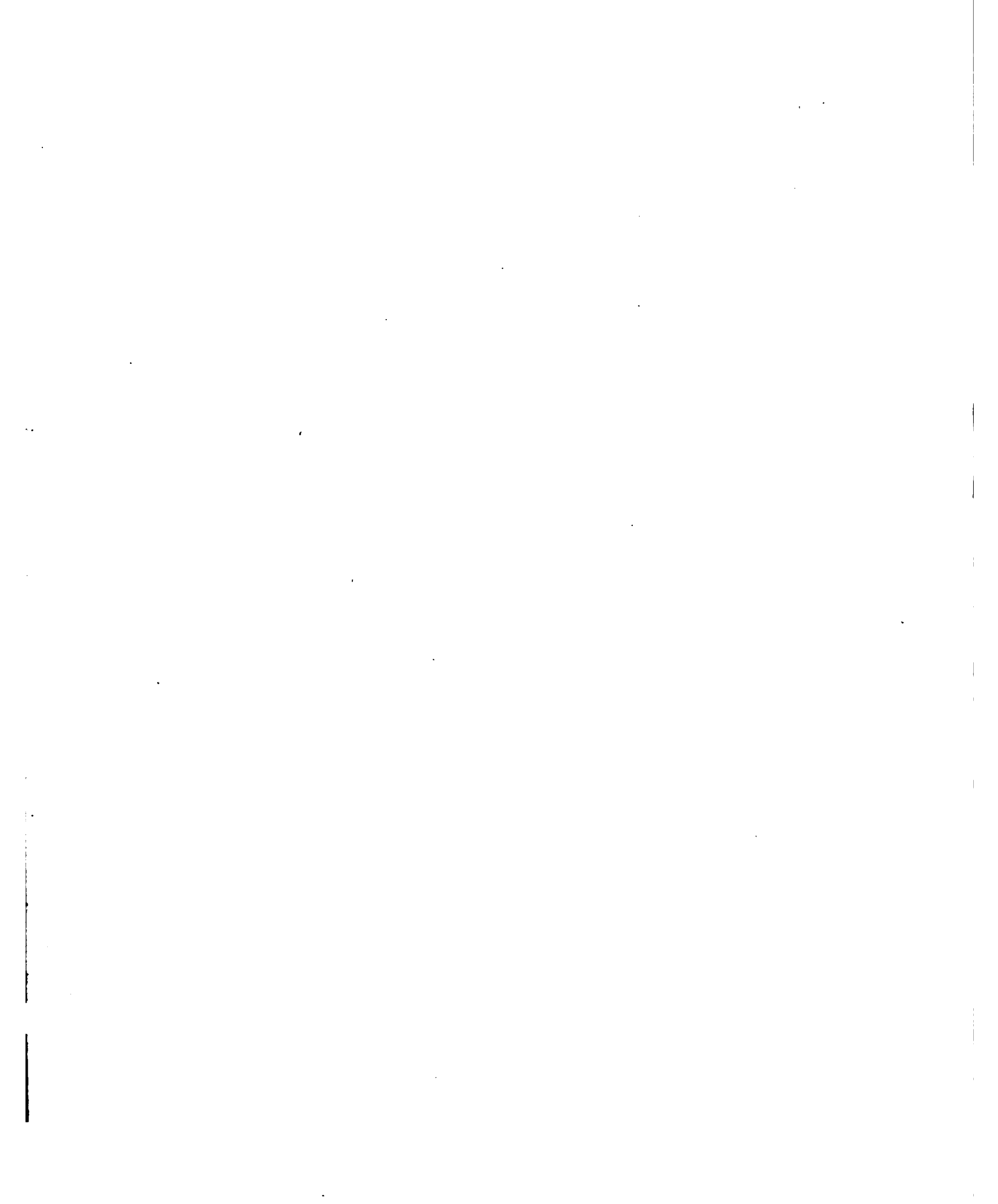


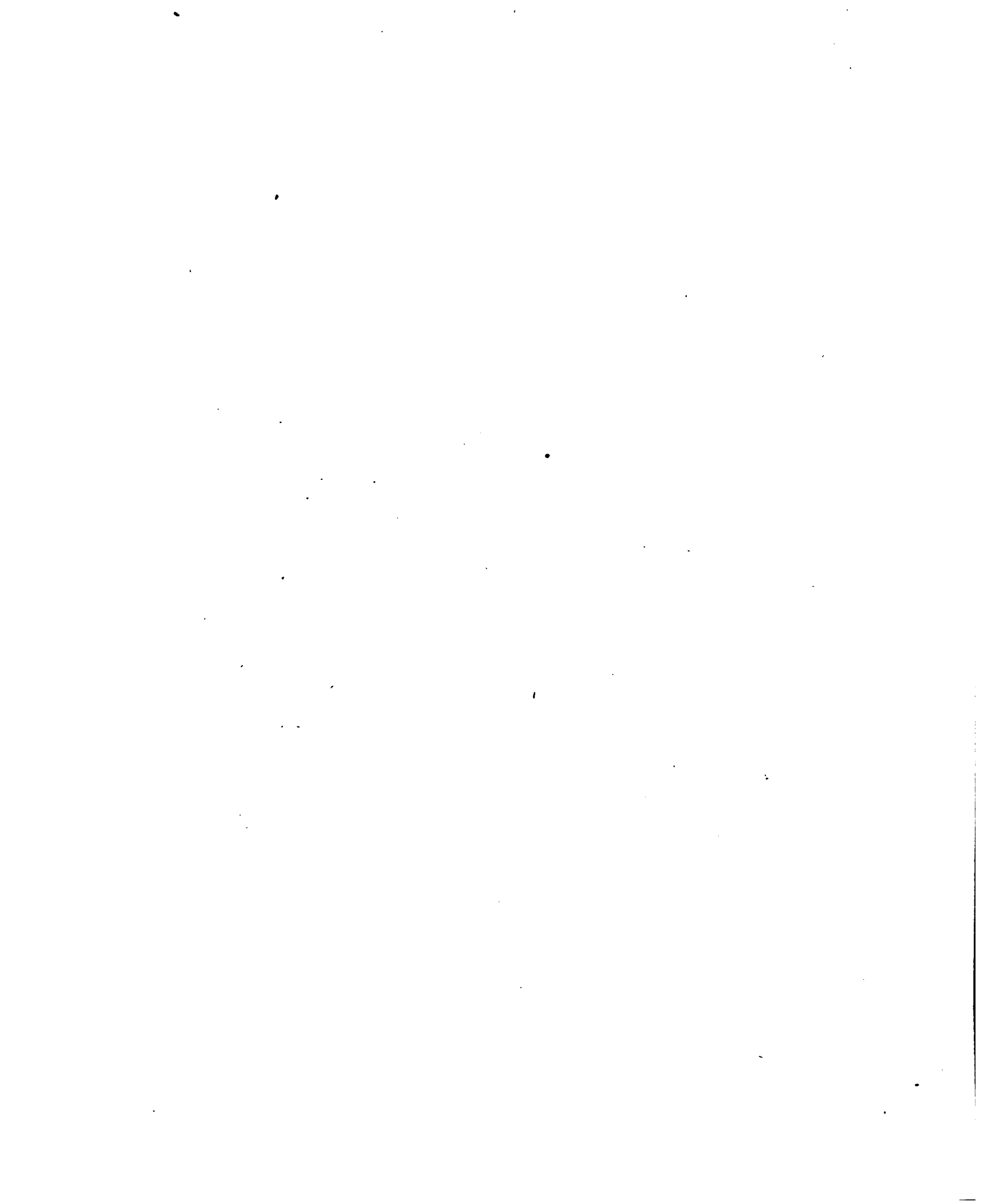




le.
3 metres







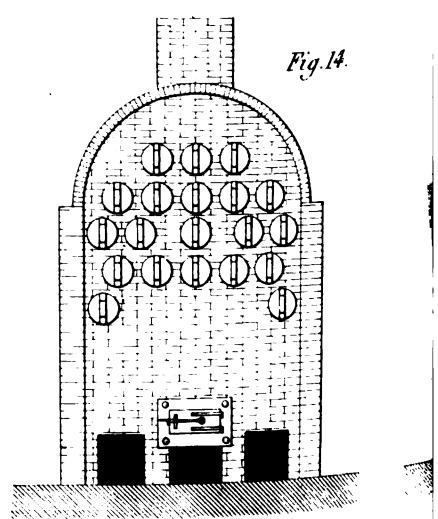
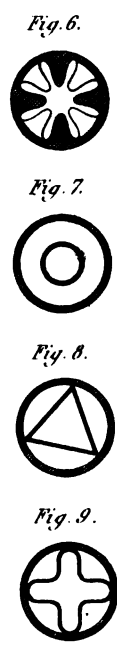
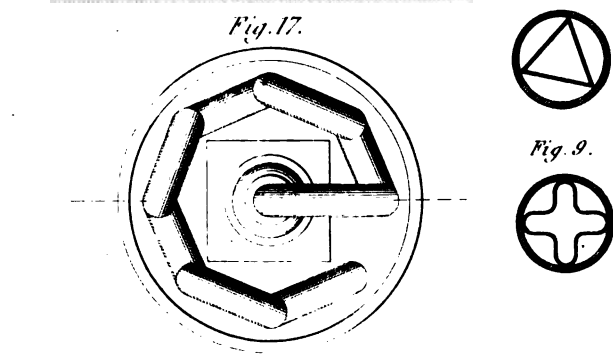
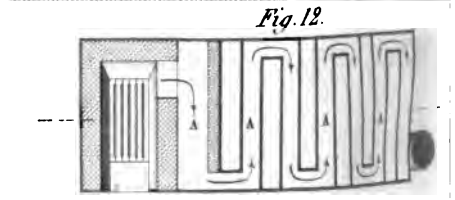
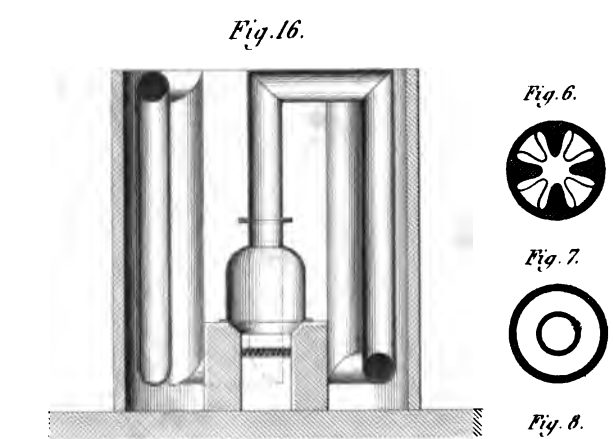
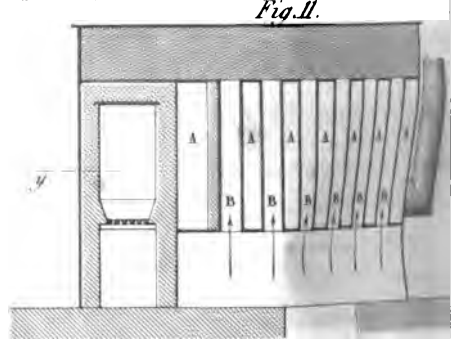
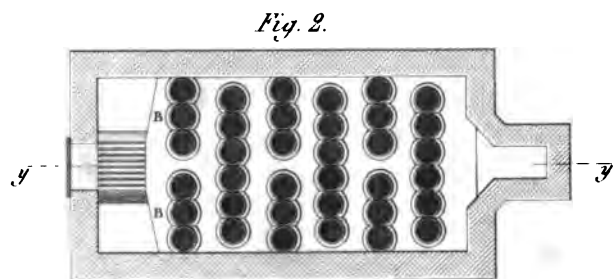
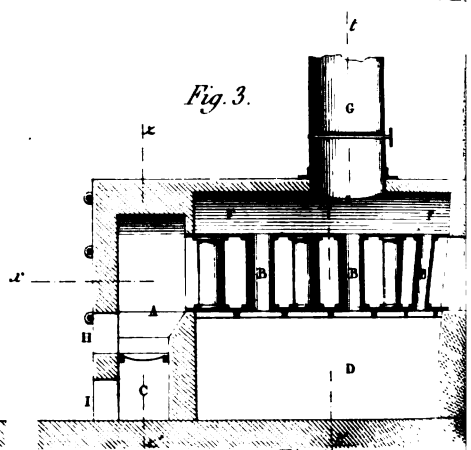
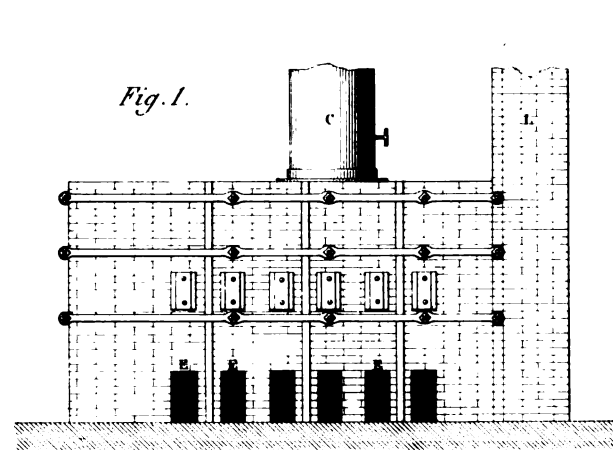


Fig. 4.

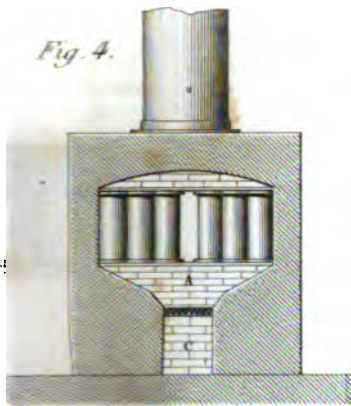


Fig. 5.

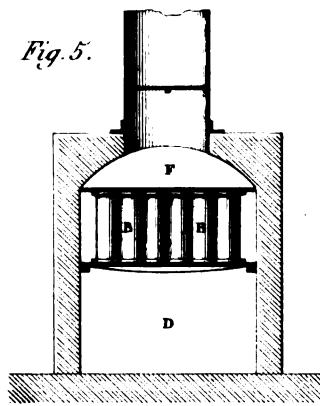


Fig. 10.

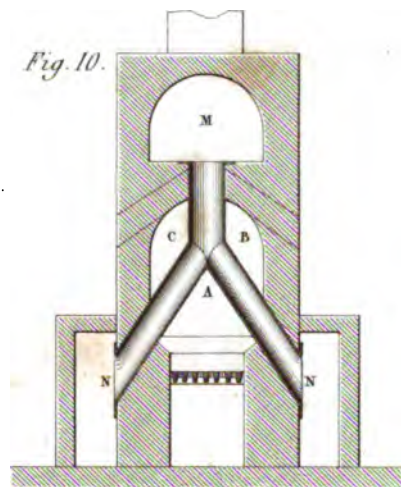


Fig. 13.

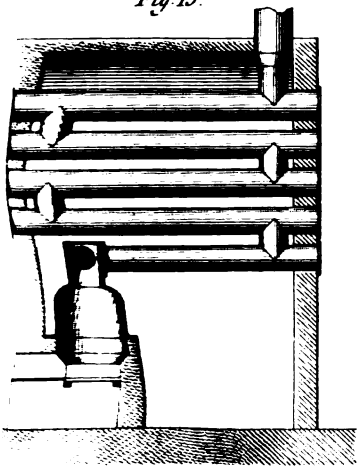


Fig. 18.

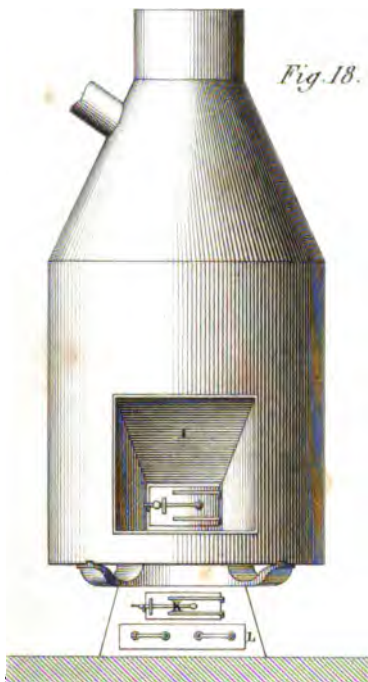


Fig. 19.

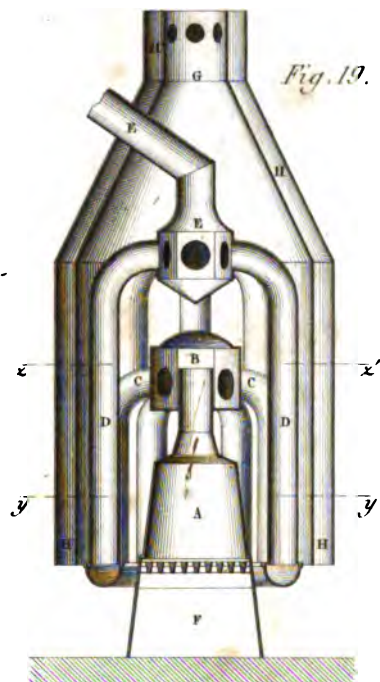


Fig. 15.

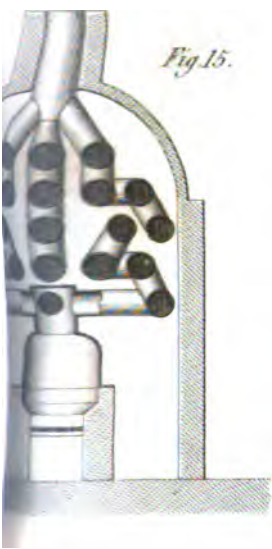


Fig. 20.

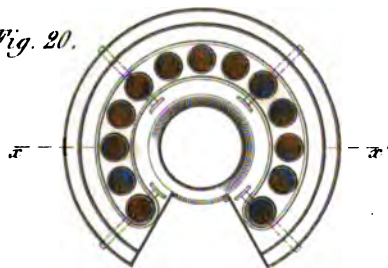
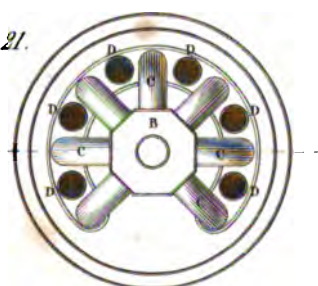
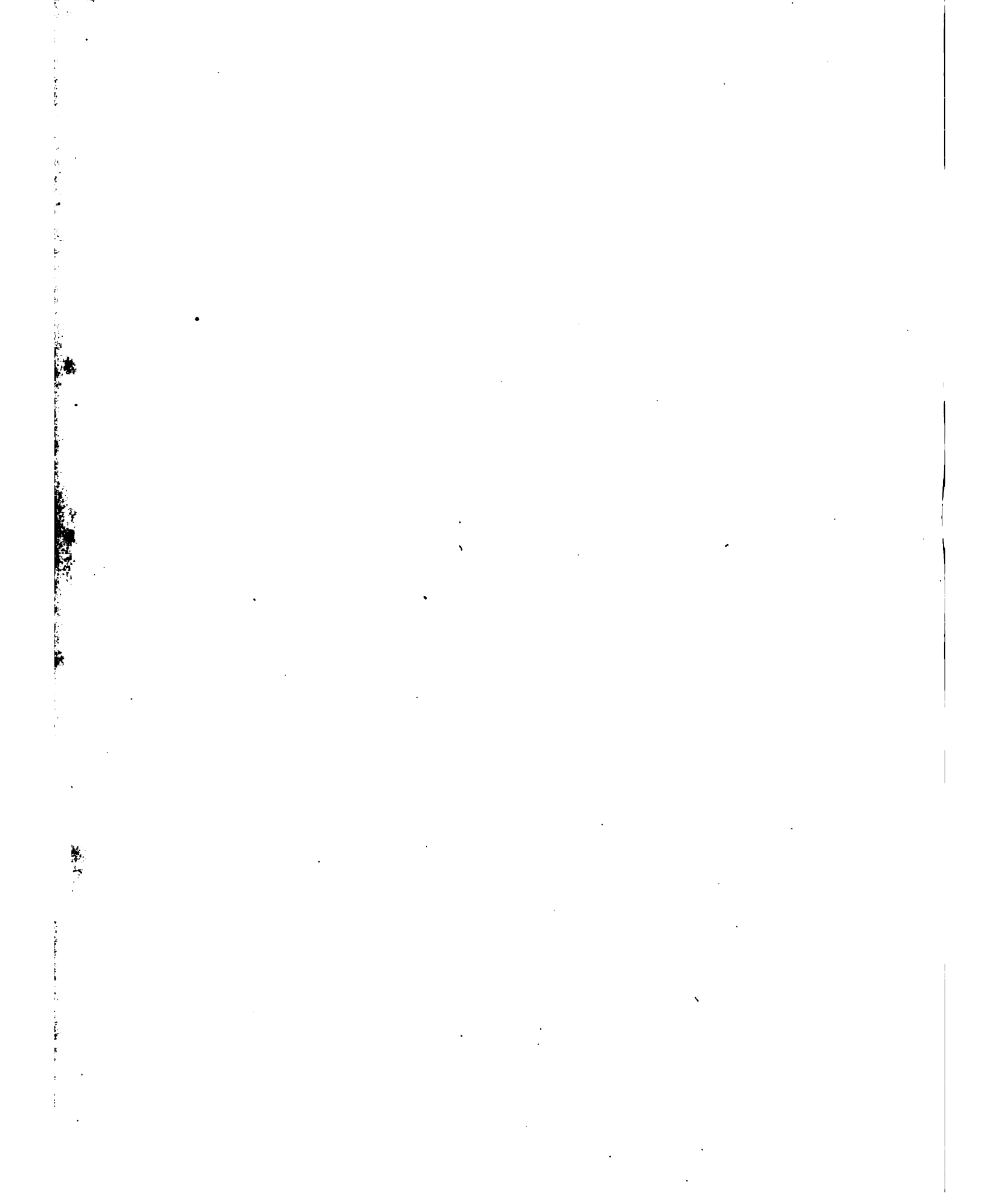


Fig. 21.



Echelle des Fig. 1, 3, 4, 5, 10, 13, 14 & 15.

0 1 2 3 4 mètres.





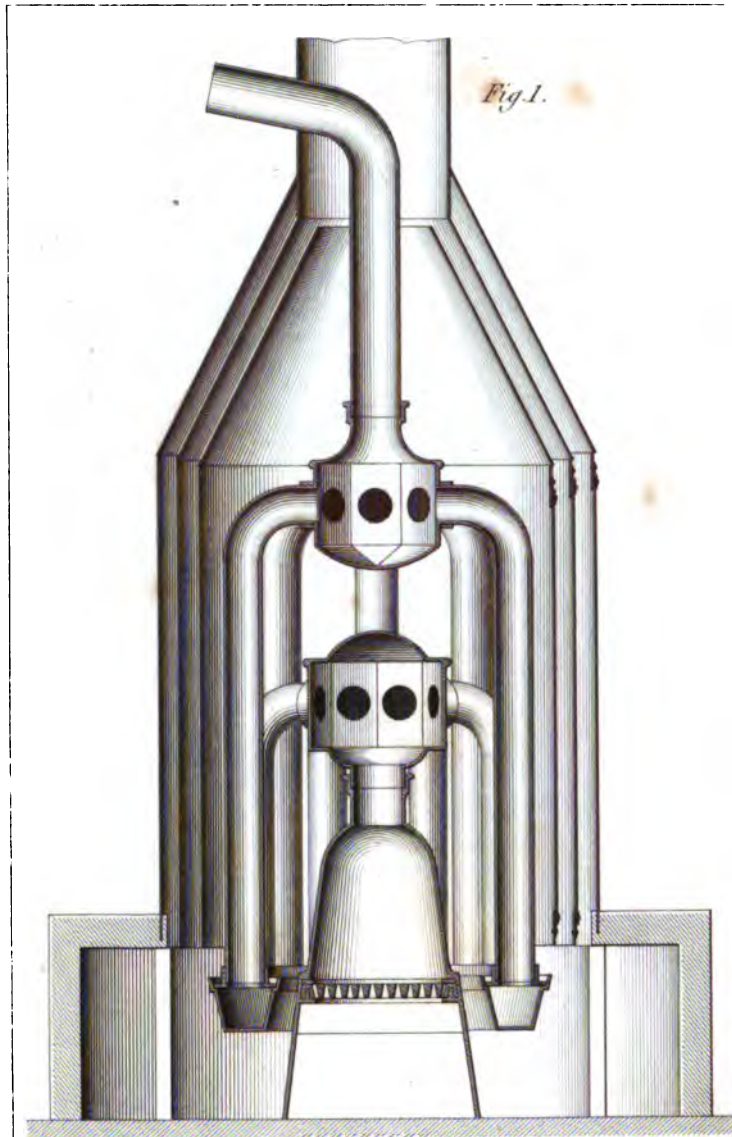


Fig. 1.

Echelle des Fig. 1 et 2
1/2 mètre.

Fig. 2.

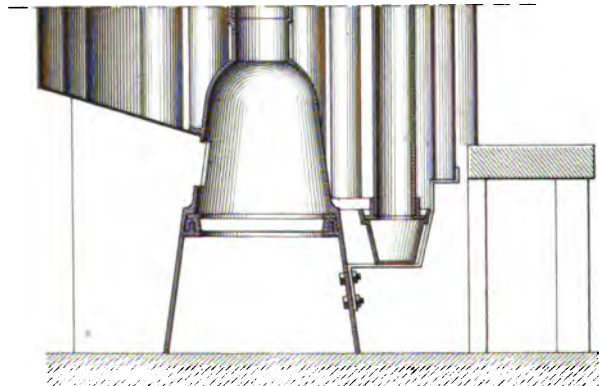


Fig. 3.

Fig. 7.

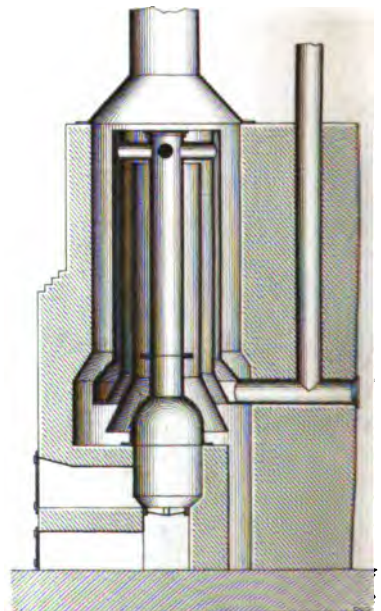


Fig. 4.

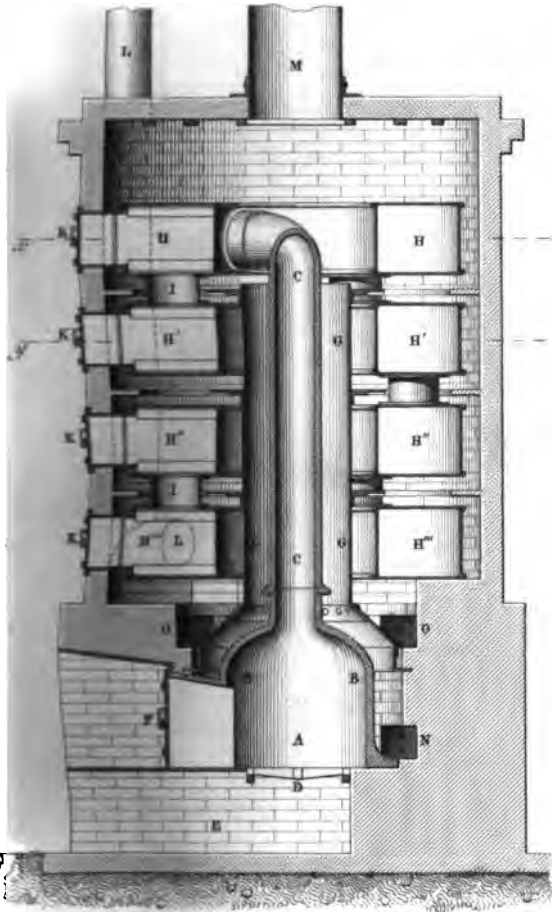


Fig. 5.

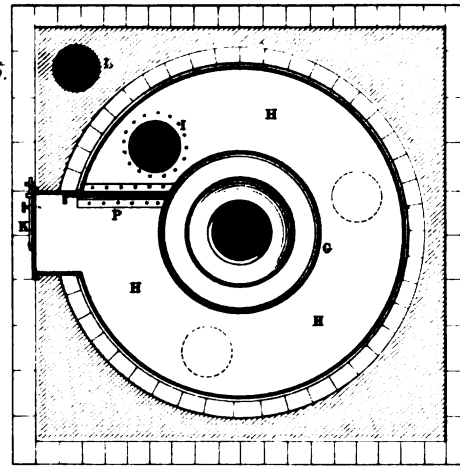
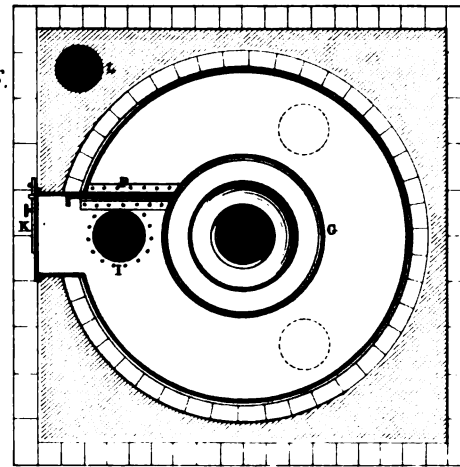


Fig. 6.



Echelle des Fig. 3, 4, 5 et 6.

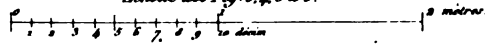


Fig. 8.

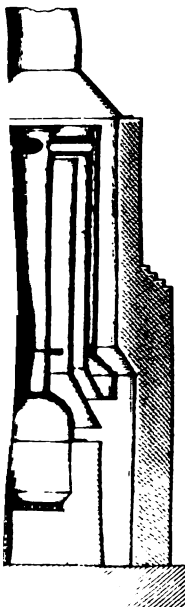


Fig. 9.

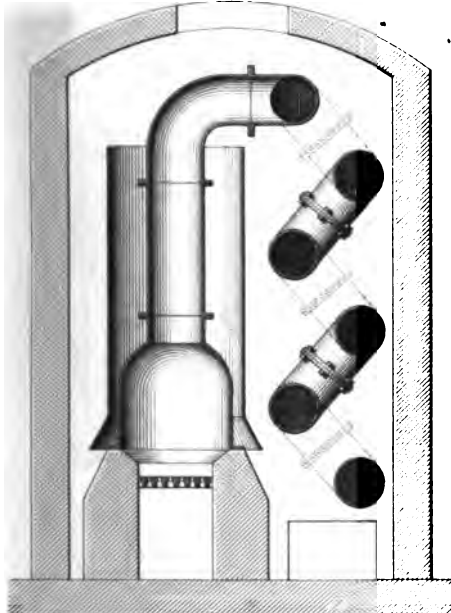
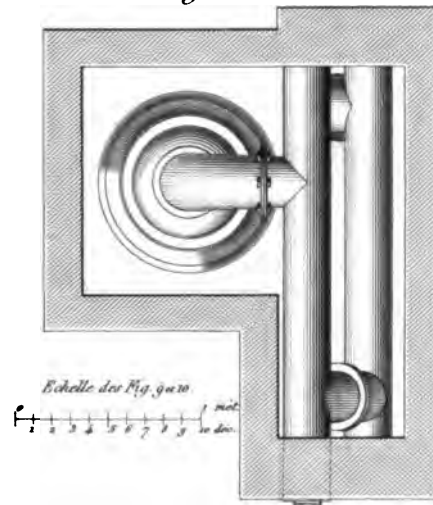
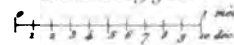
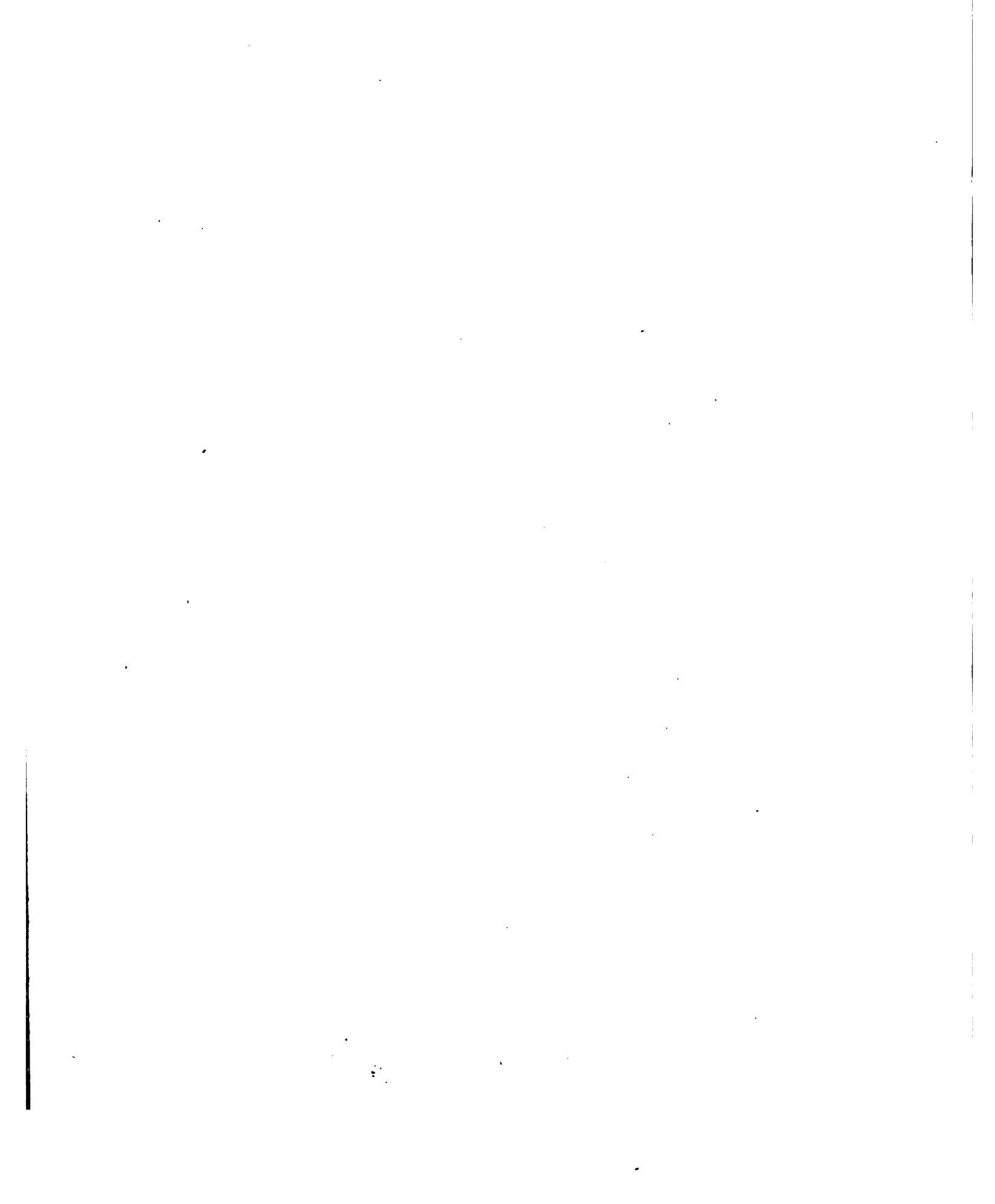


Fig. 10.

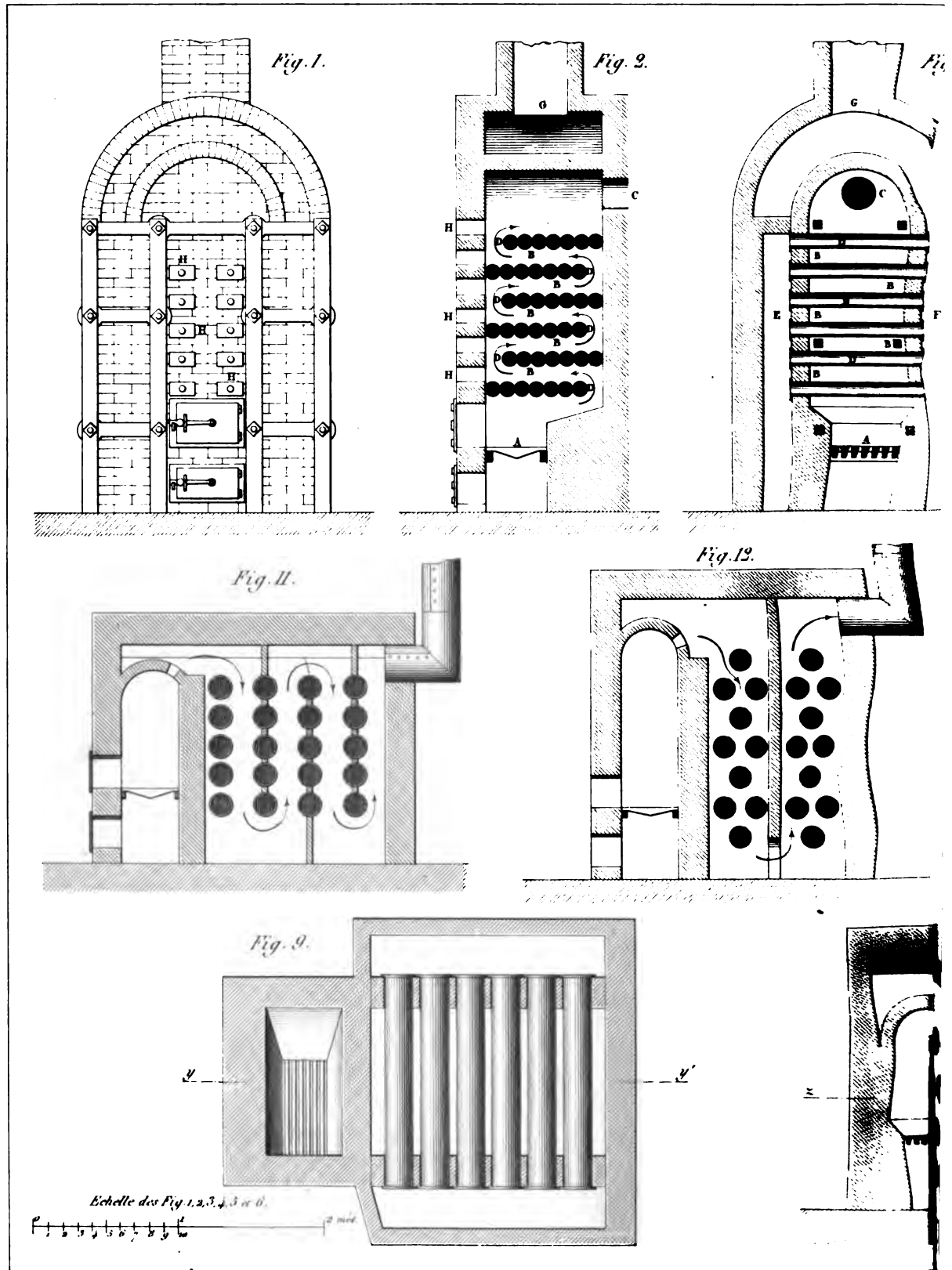


Echelle des Fig. 9 et 10.









3.

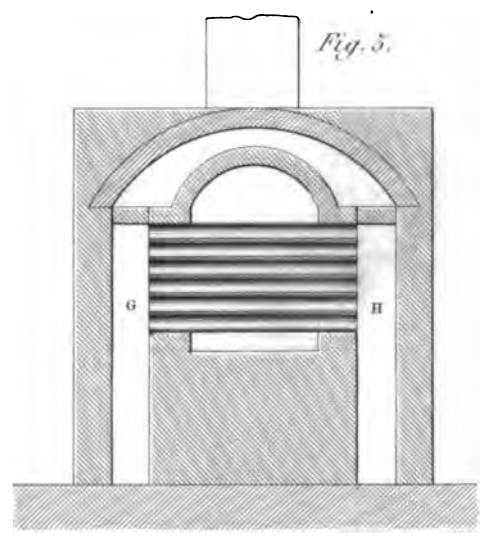
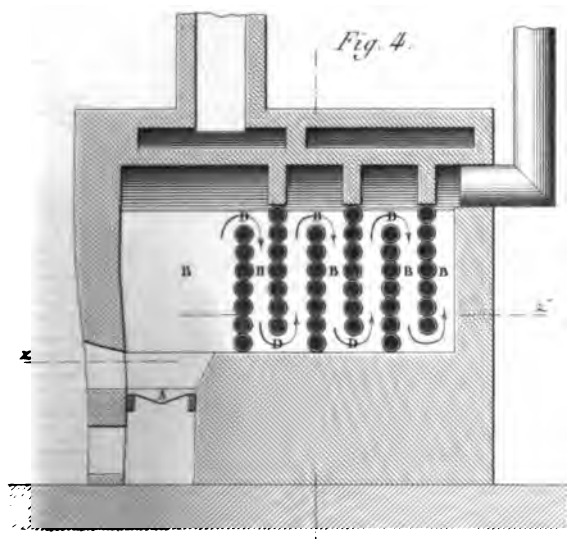


Fig. 6.

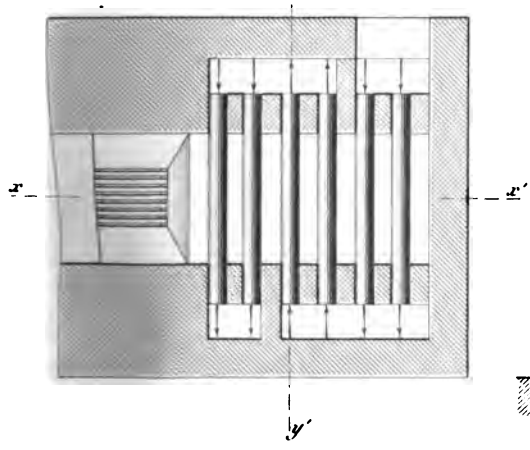


Fig. 8.

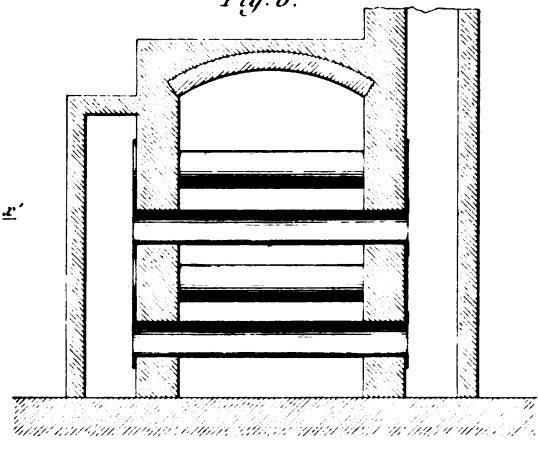


Fig. 7.

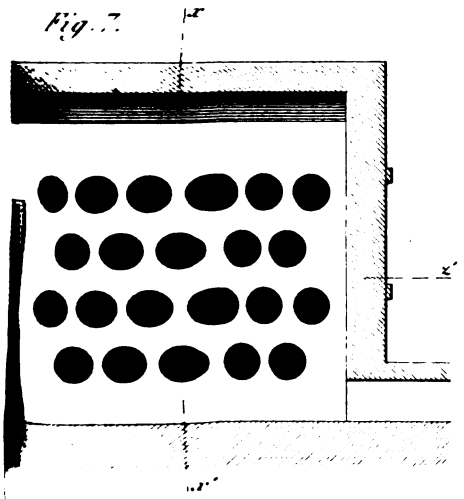
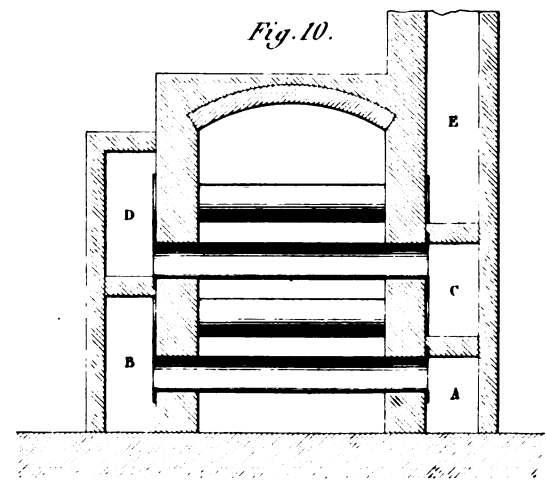
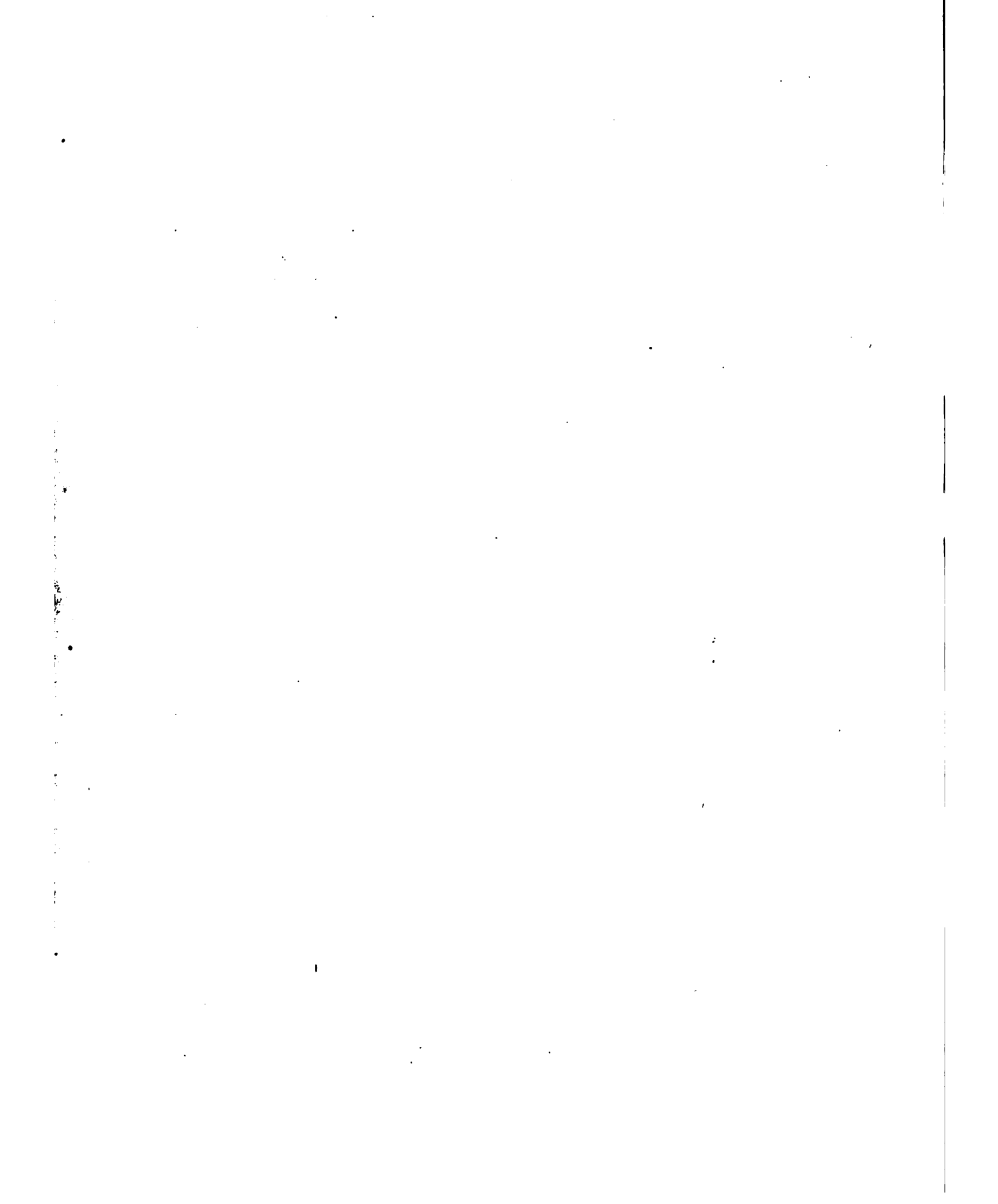


Fig. 10.





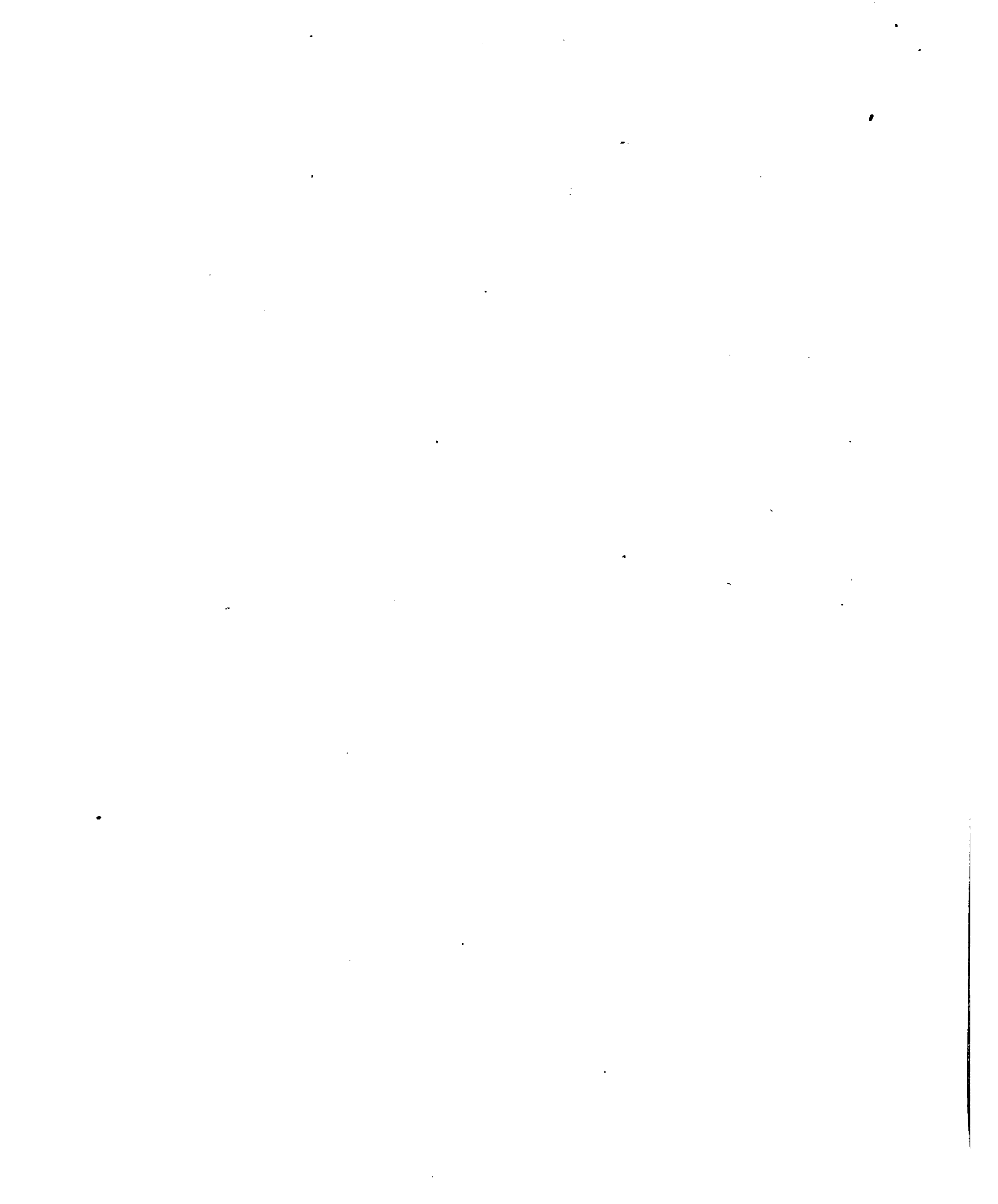


Fig. 6.

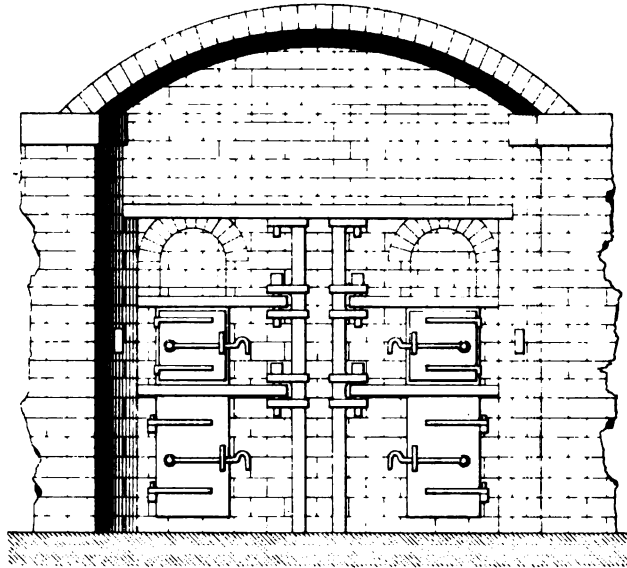


Fig. 8.

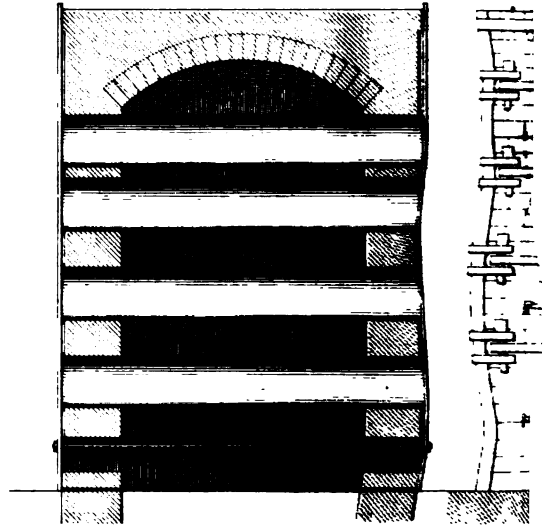


Fig. 7.

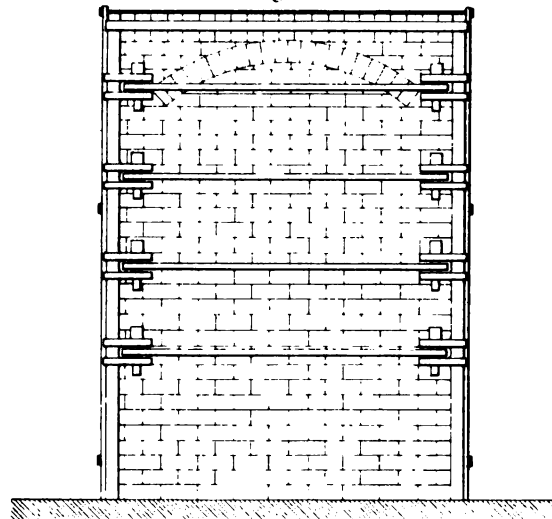


Fig. 9.

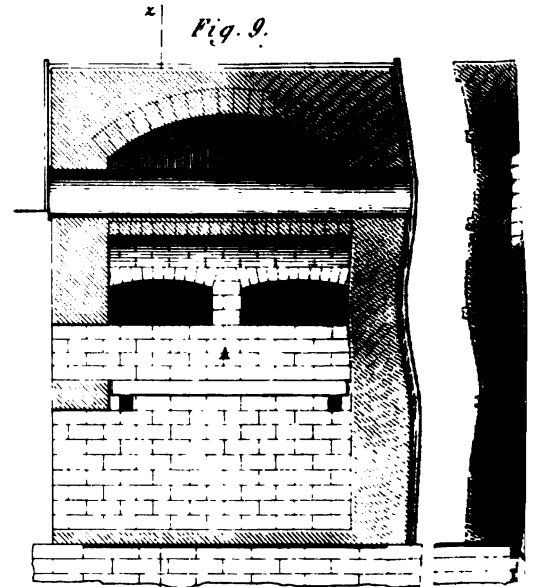


Fig. 12.

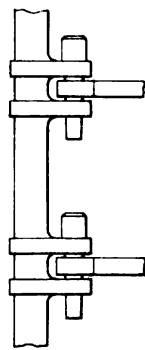


Fig. 13.

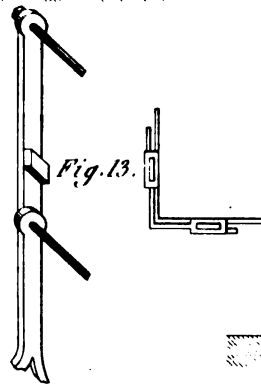


Fig. 3.

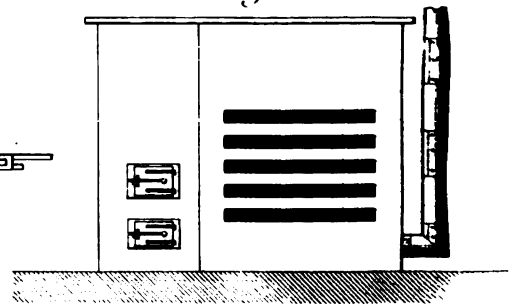


Fig. 10

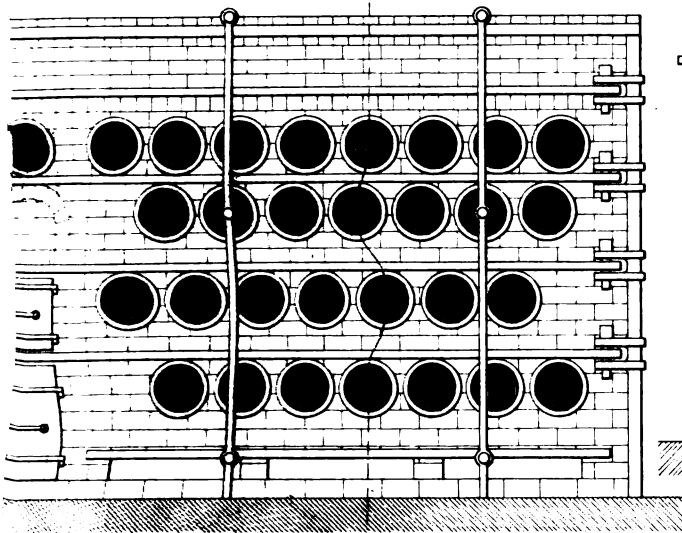


Fig. 1.

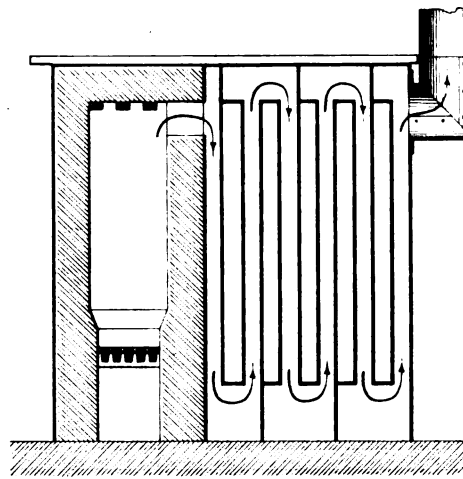


Fig. 11.

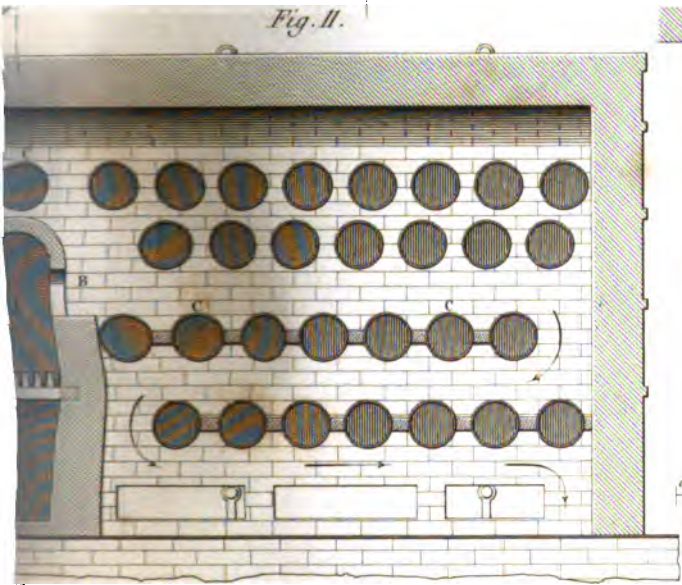
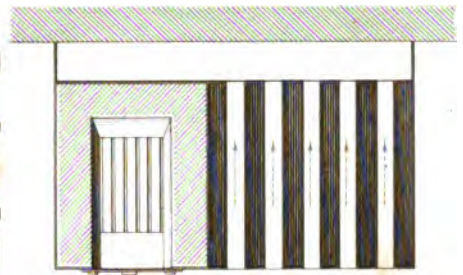


Fig. 2.



Echelle des Fig. 6, 7, 8, 9, 10 et 11.

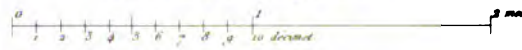
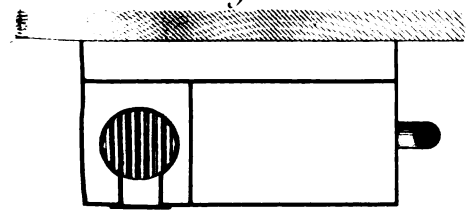


Fig. 5.



Echelle des Fig. 3, 4 et 5.

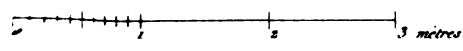
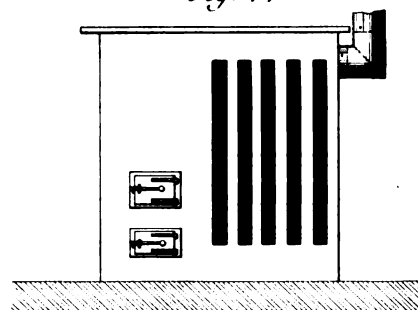
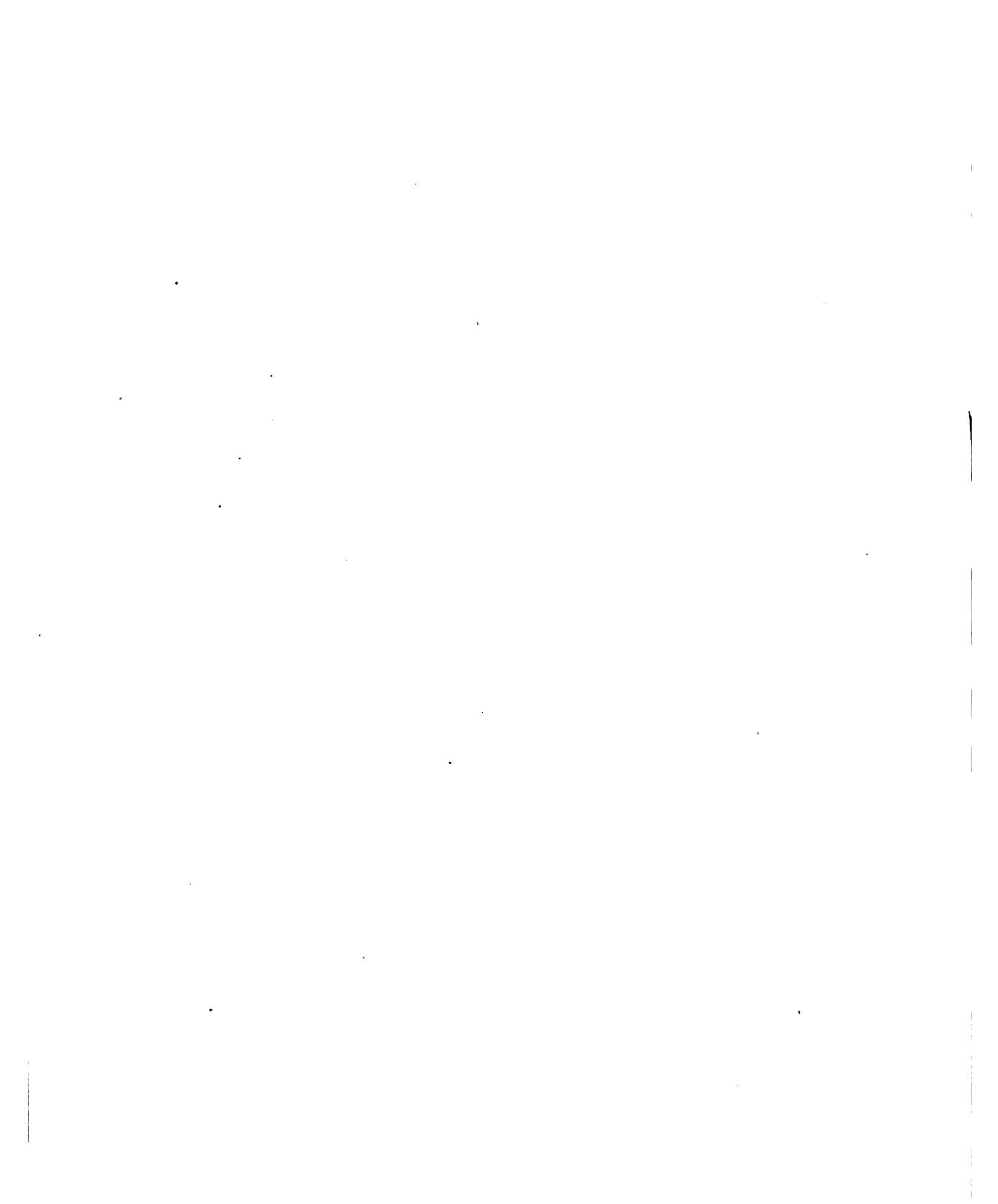


Fig. 4.





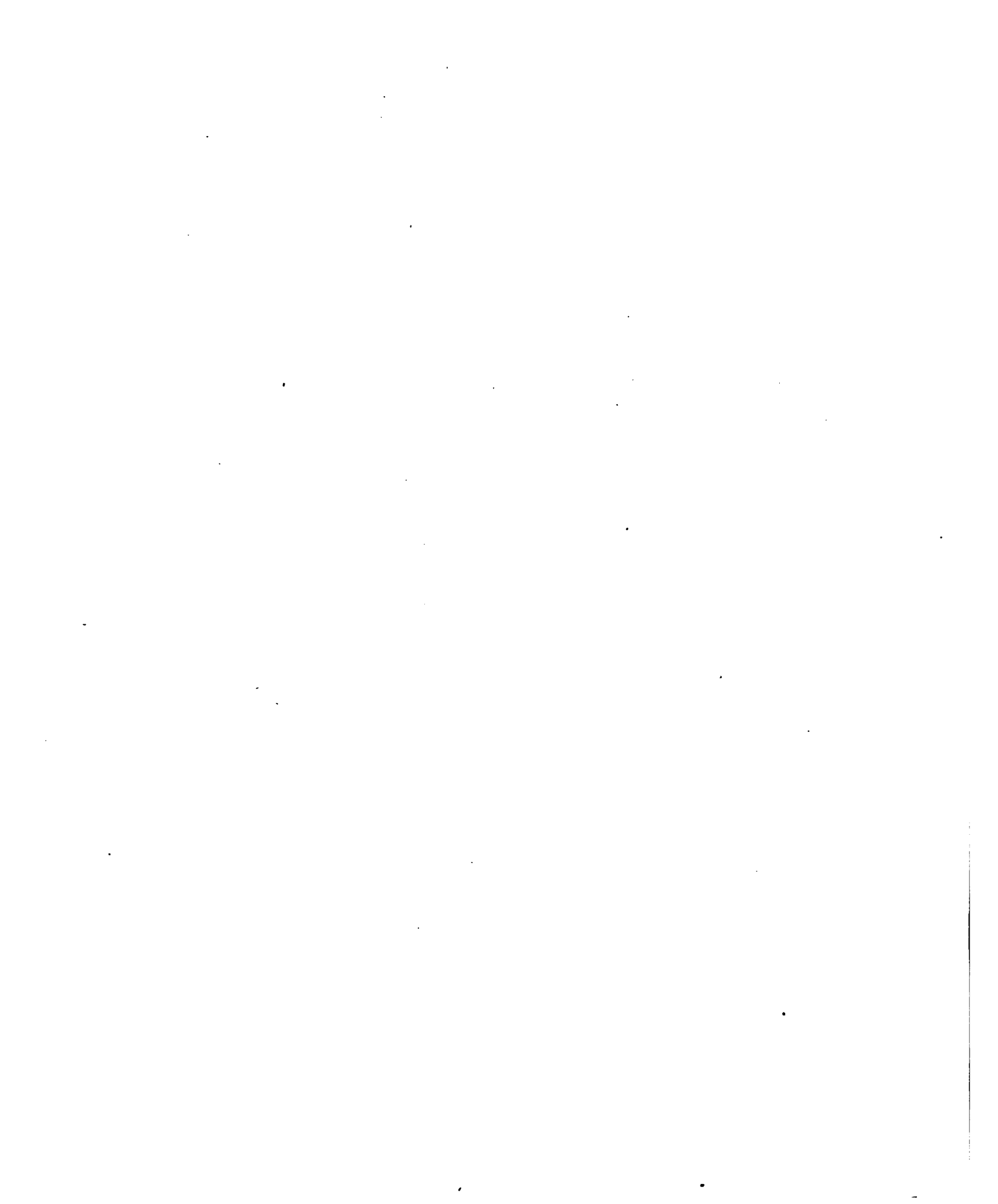


Fig. 1.

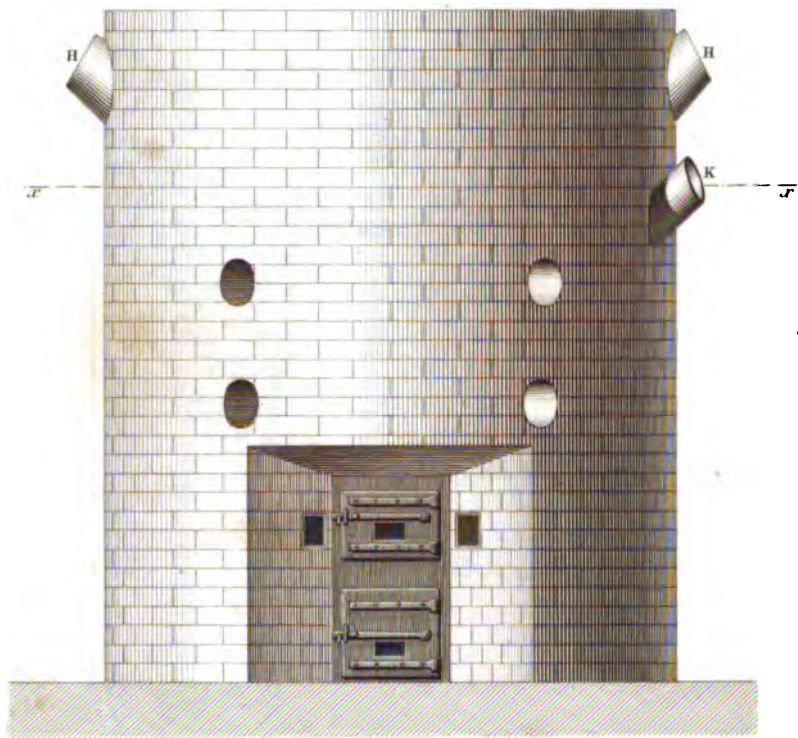


Fig. 4.

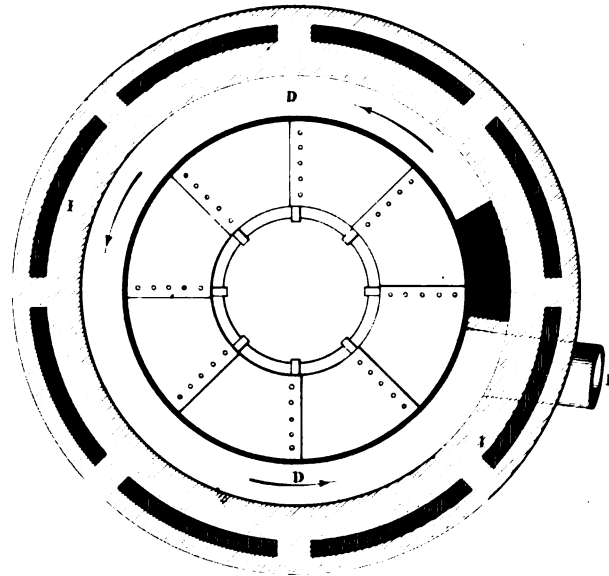
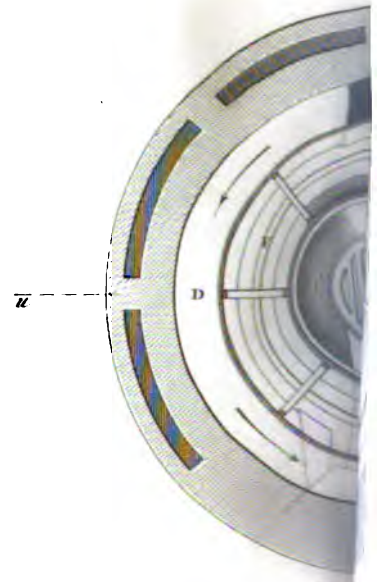
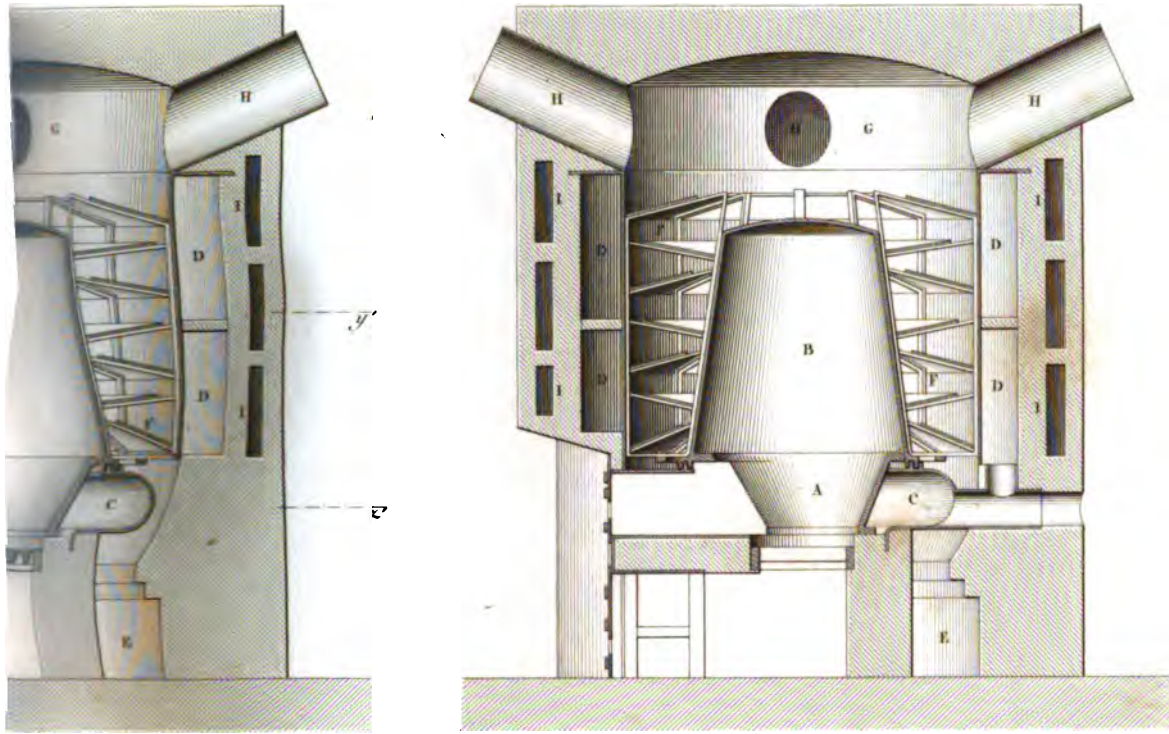


Fig.



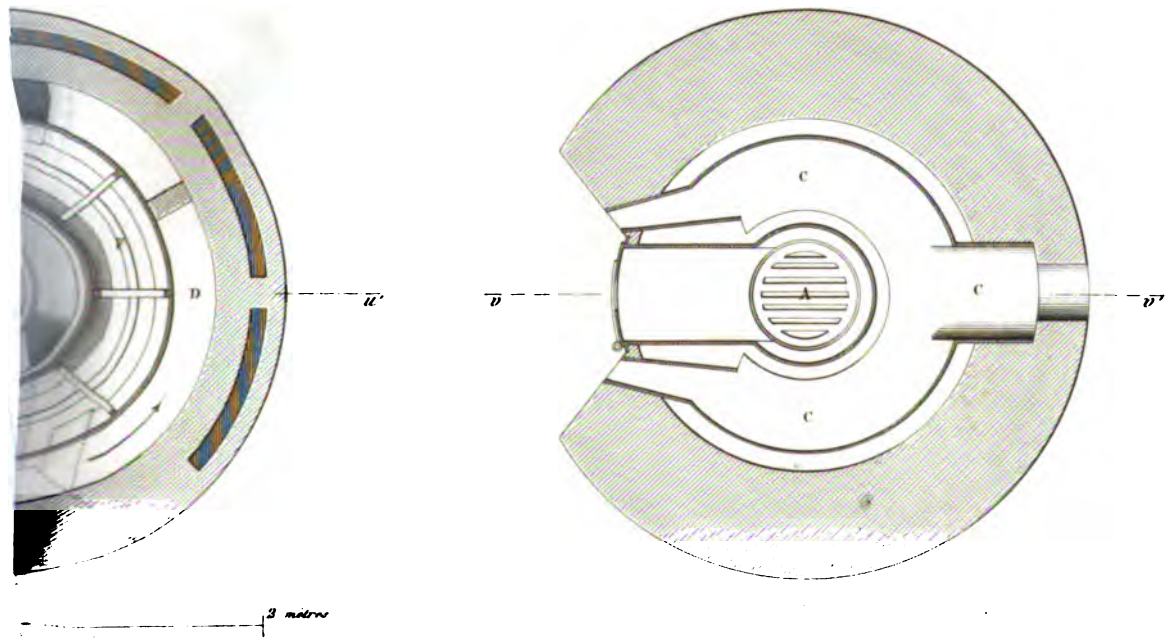
3

Fig. 3.



6

Fig. 6.



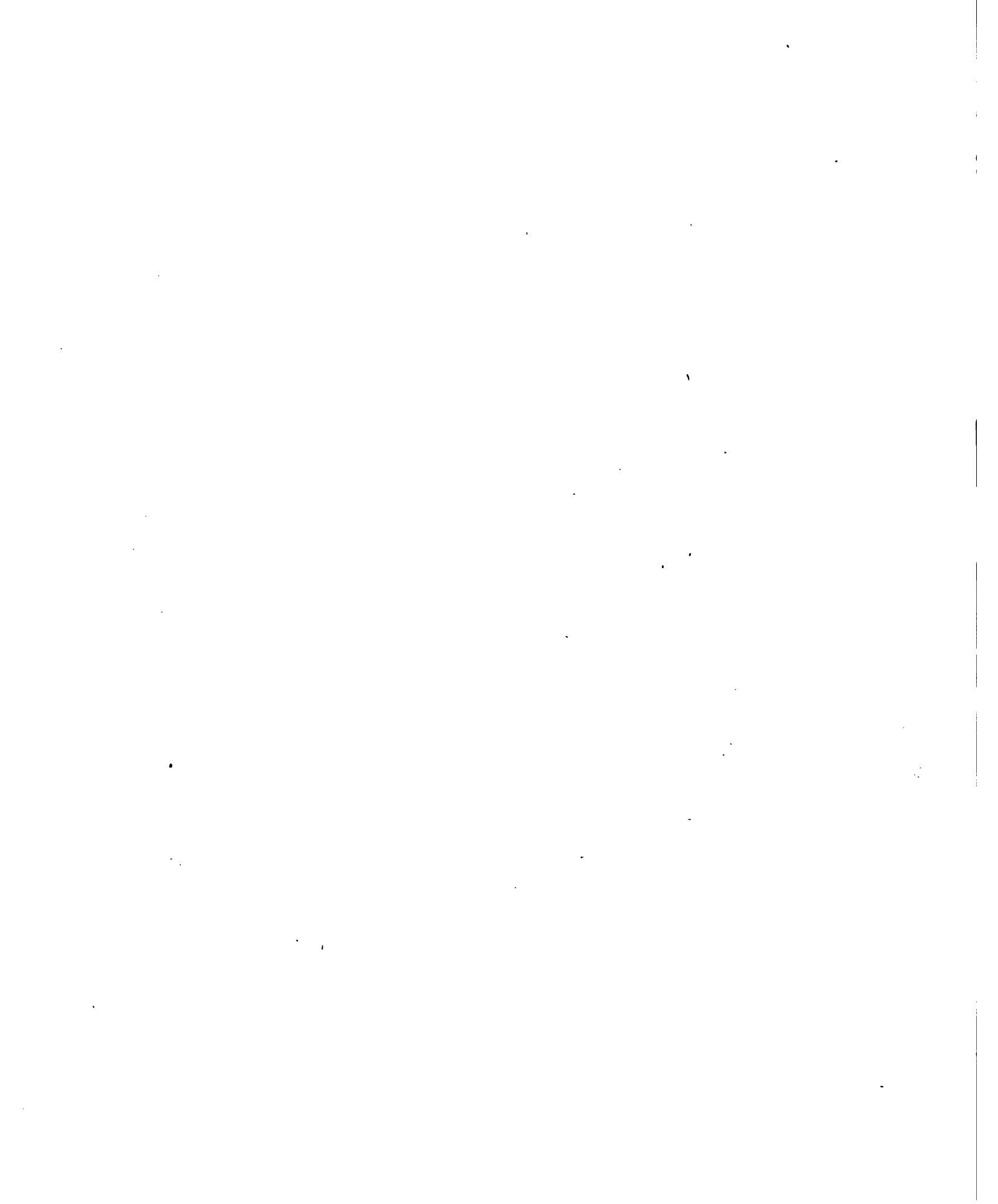


Fig. 5.

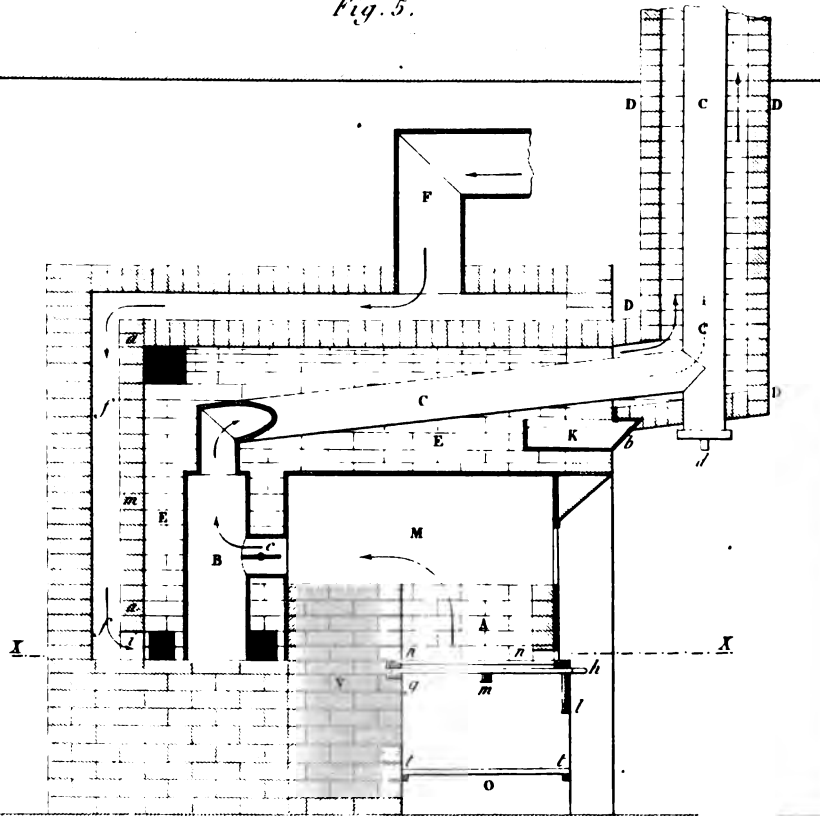
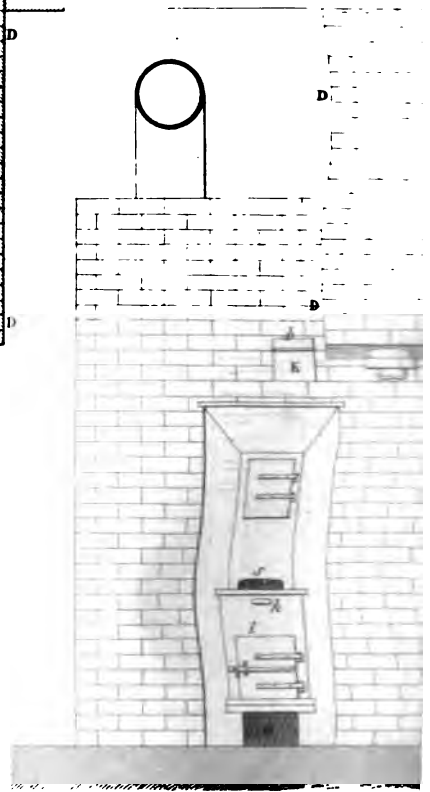


Fig. 7.



Echelle des Fig. 5, 6 et 7.

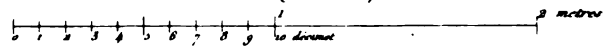


Fig. 6.

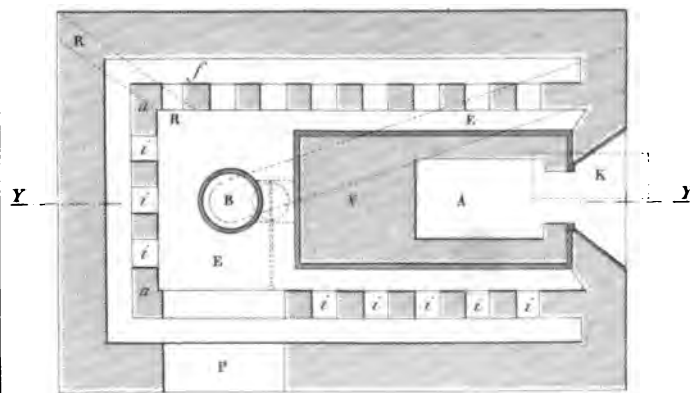


Fig. 8.

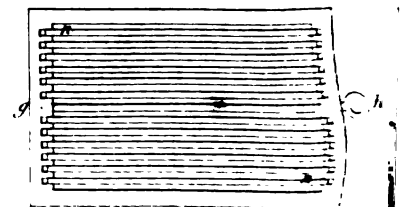


Fig. 1.

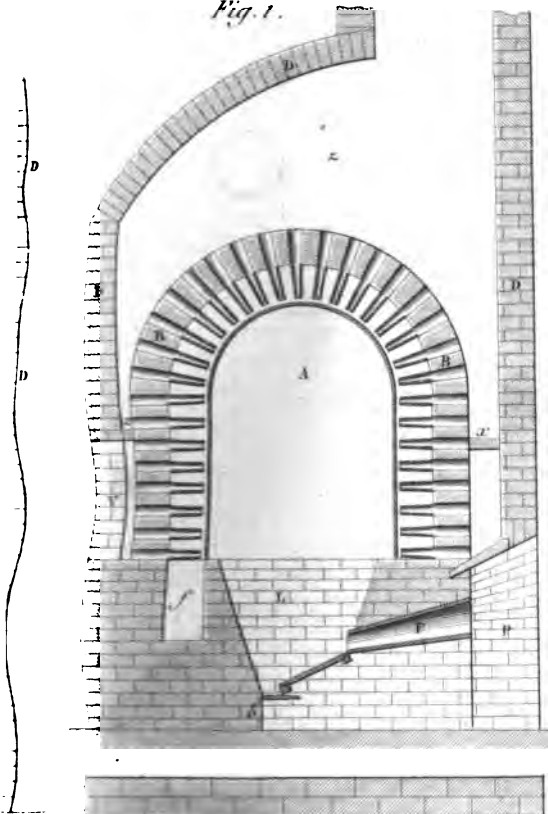


Fig. 3.

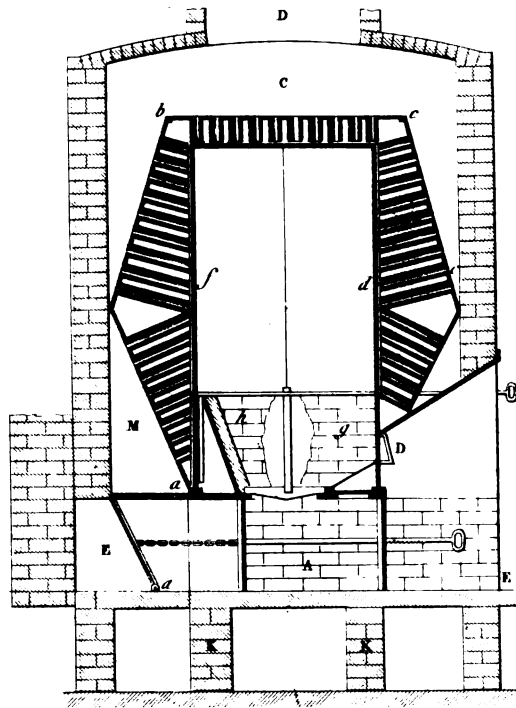


Fig. 2.

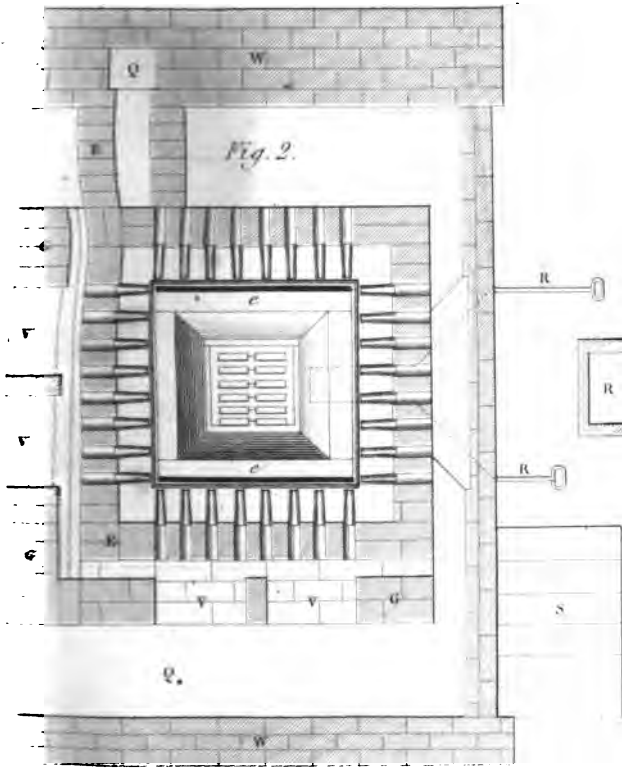
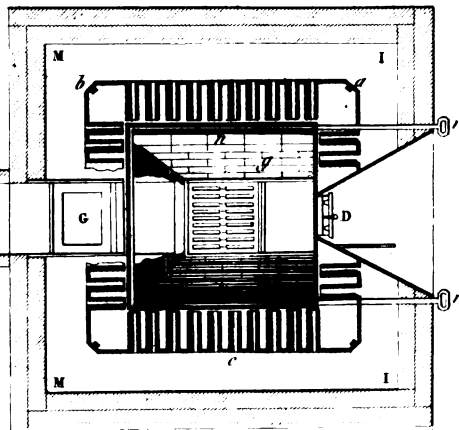
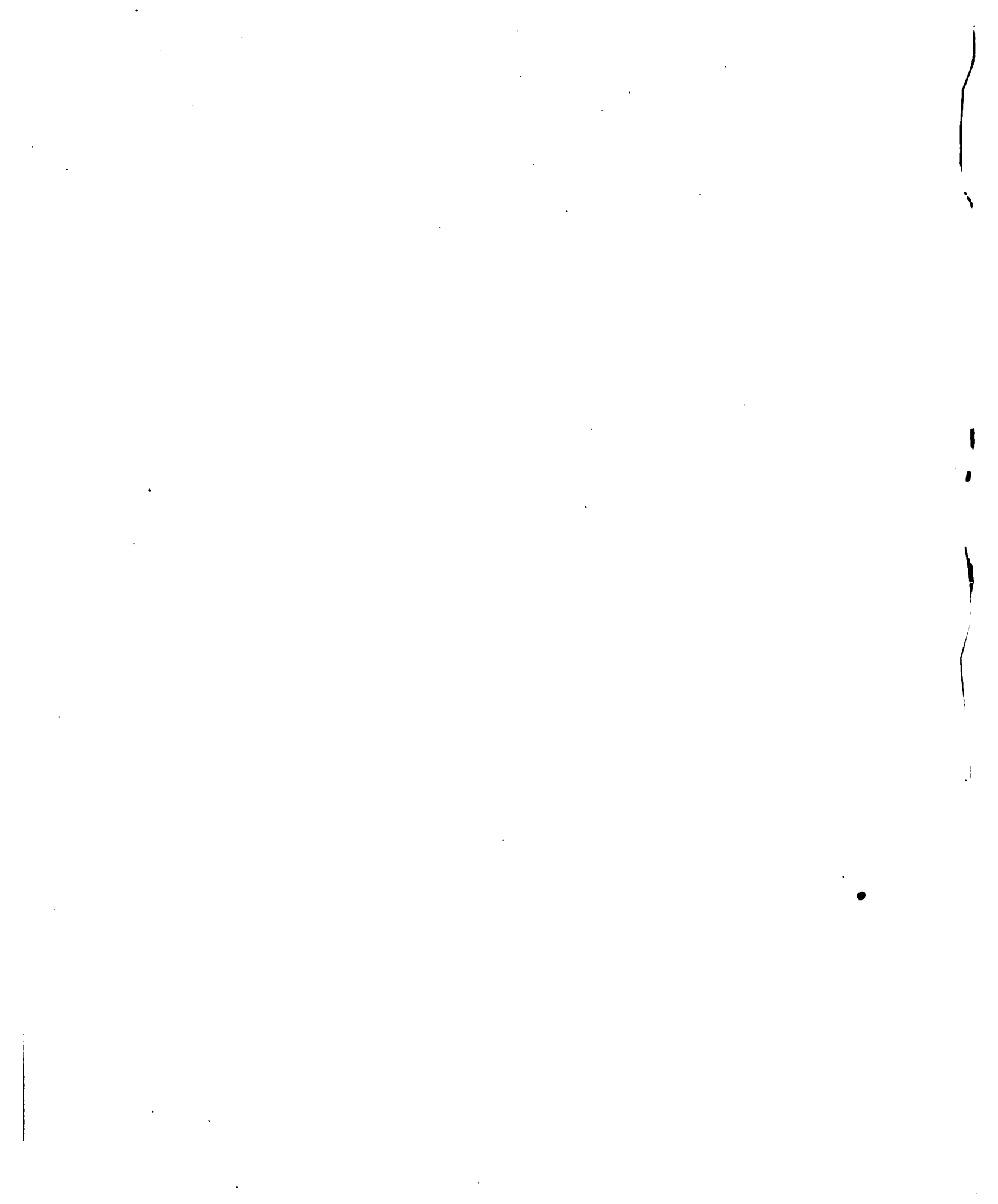
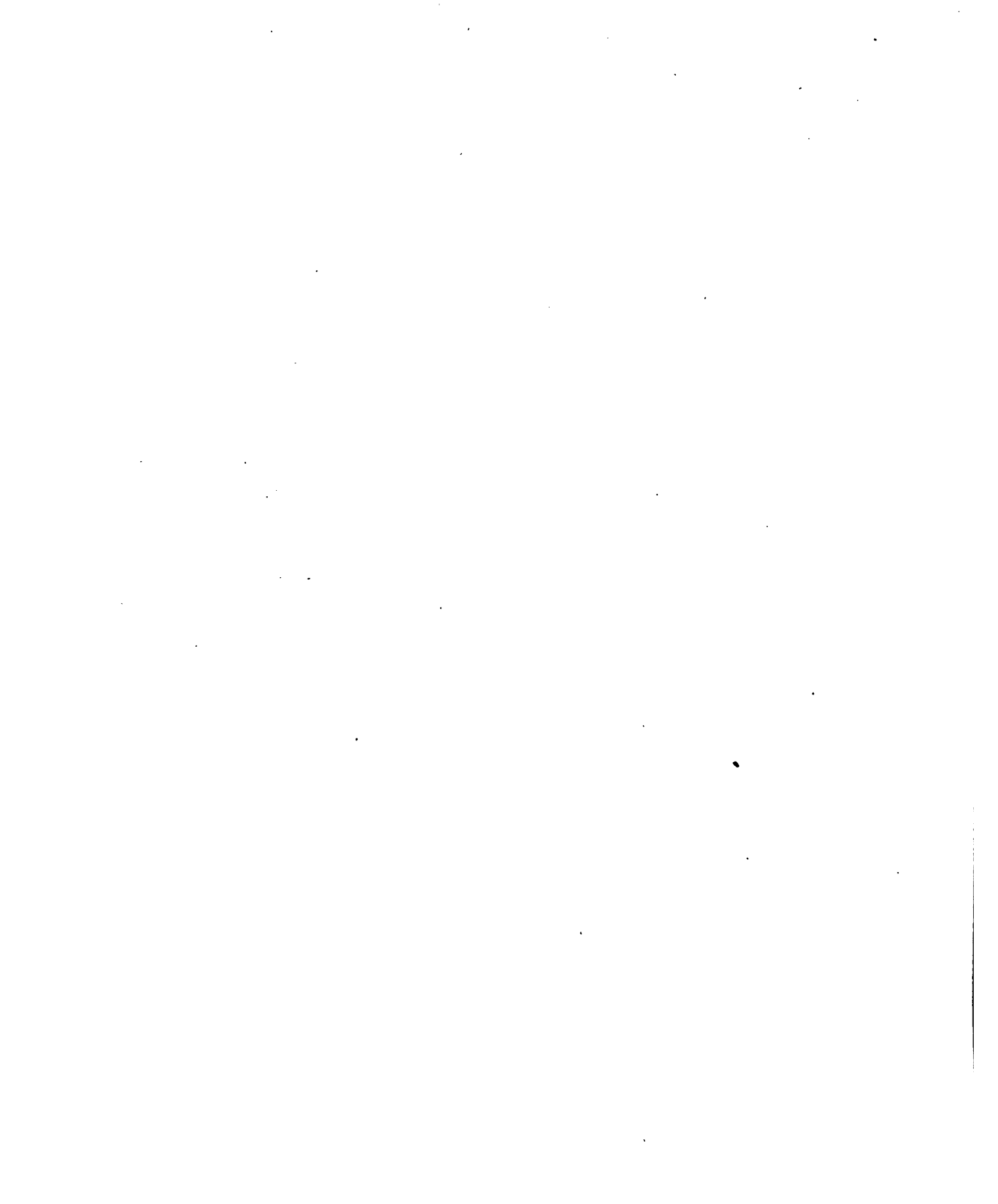
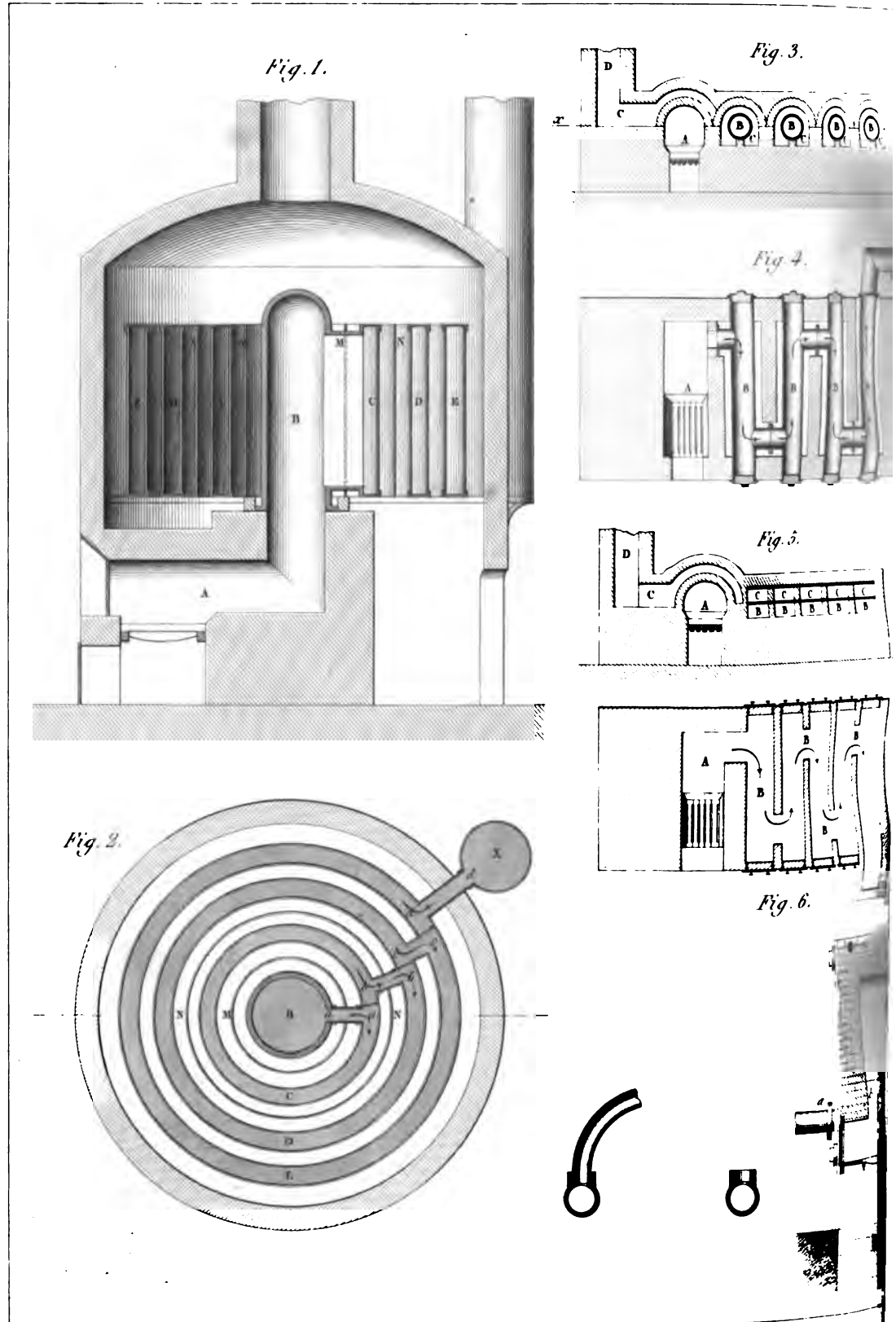


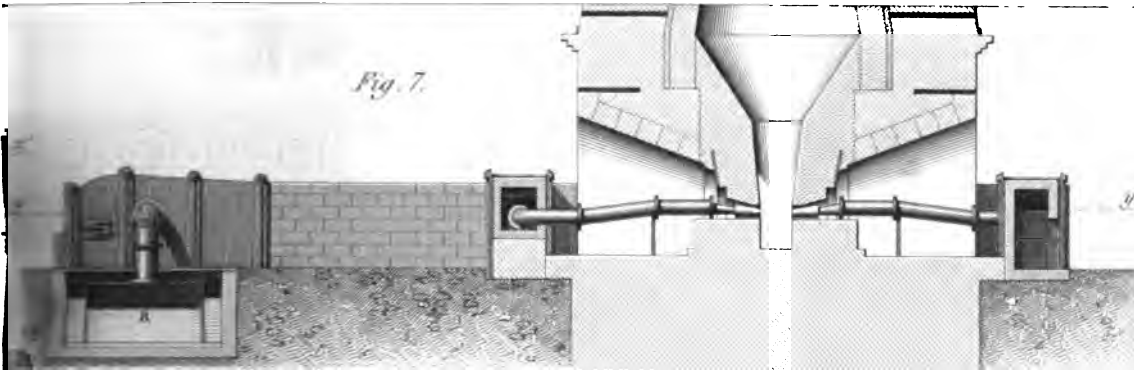
Fig. 4.



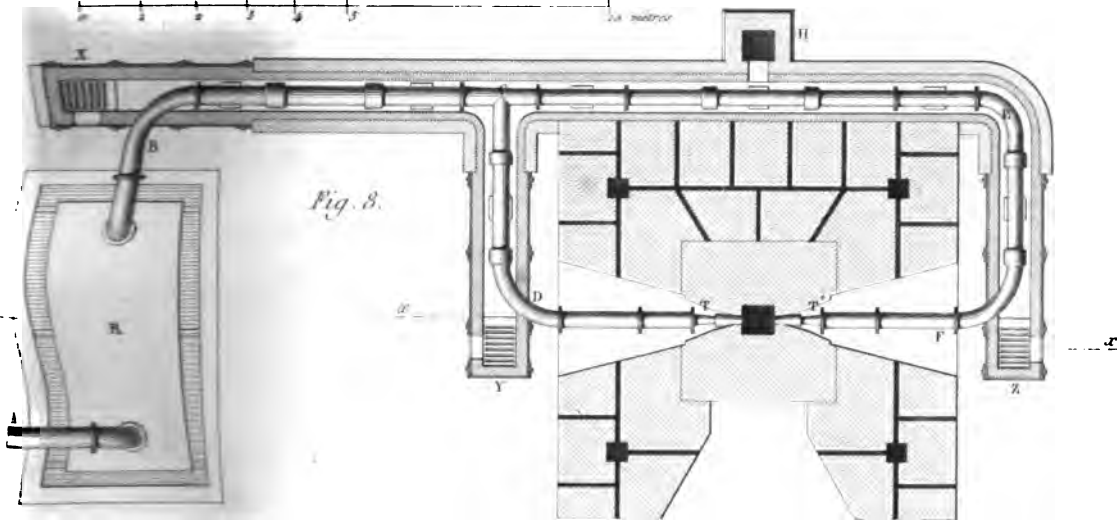




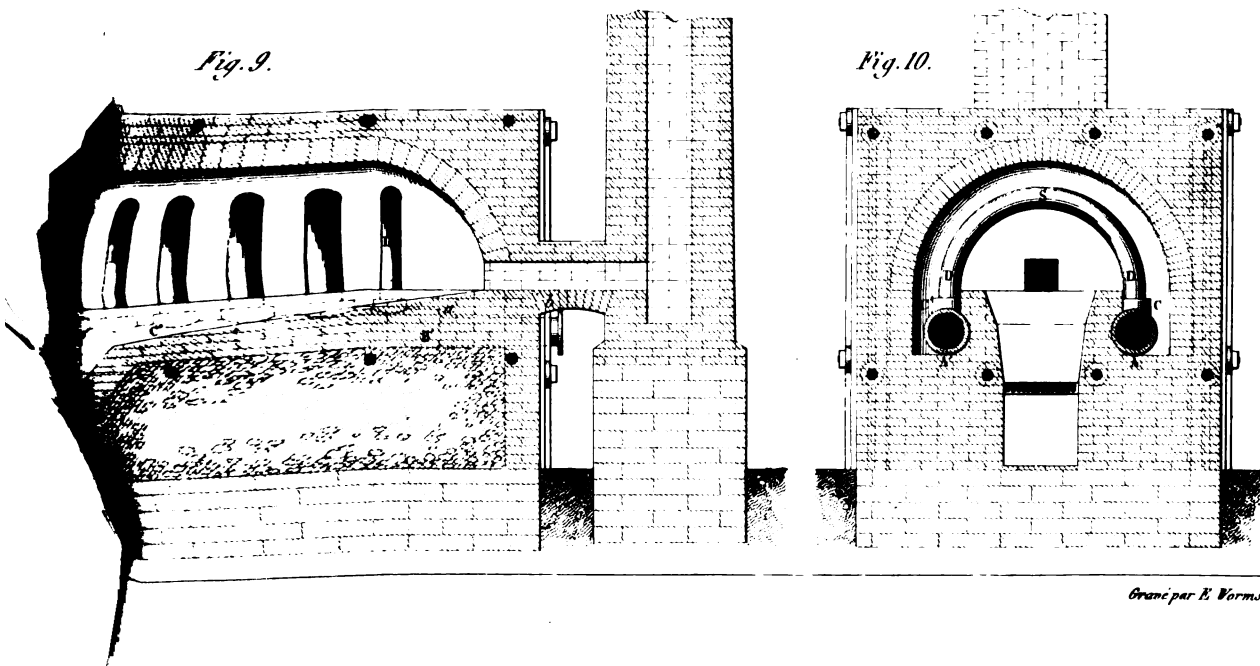




Echelle des Fig. 7 et 8.



Echelle des Fig. 9 et 10.



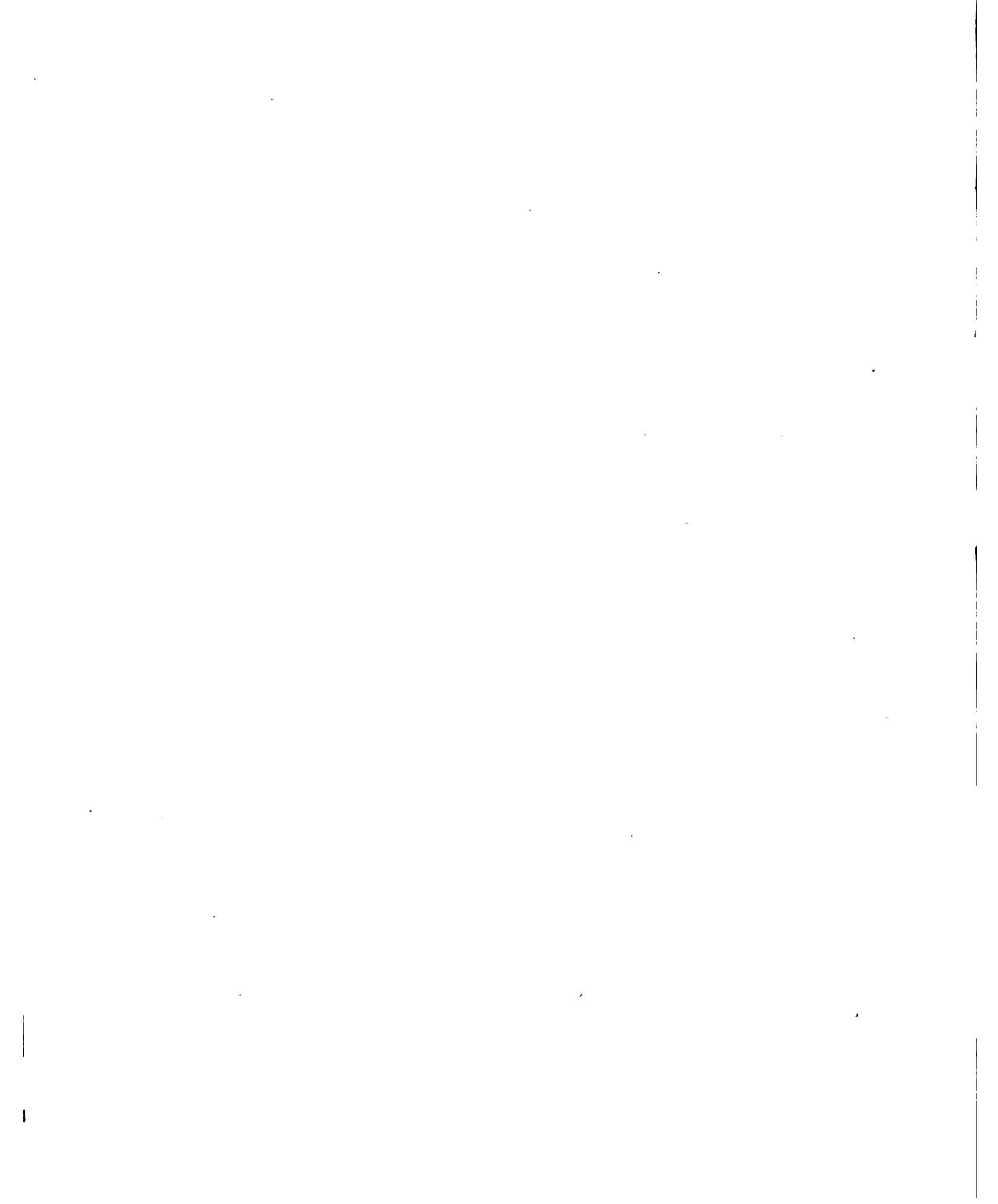




Fig. 5.

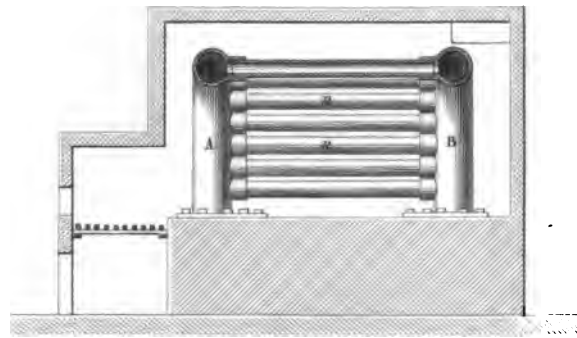


Fig. 6.

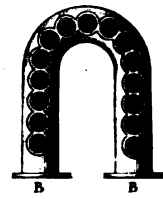


Fig. 2.

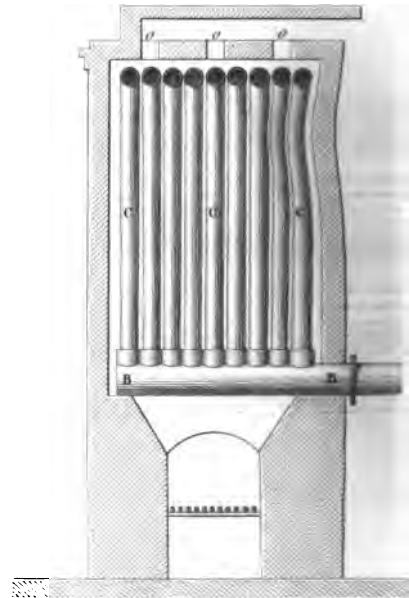


Fig. 3.



Fig. 1.

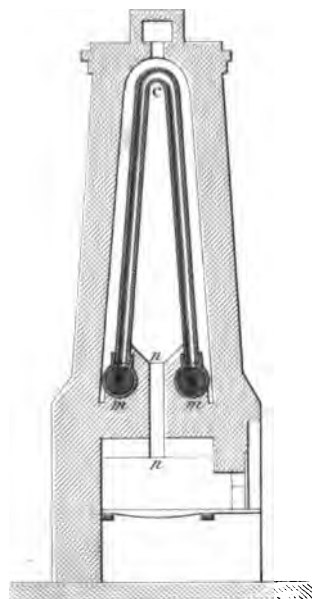
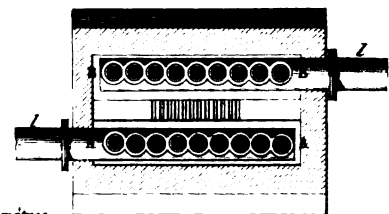


Fig. 4.



Echelle des Fig. 1, 2, 4, 5 et 6.



Echelle des Fig. 7, 8, 9 et 10.

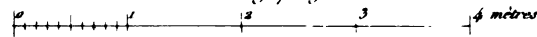


Fig. 7.

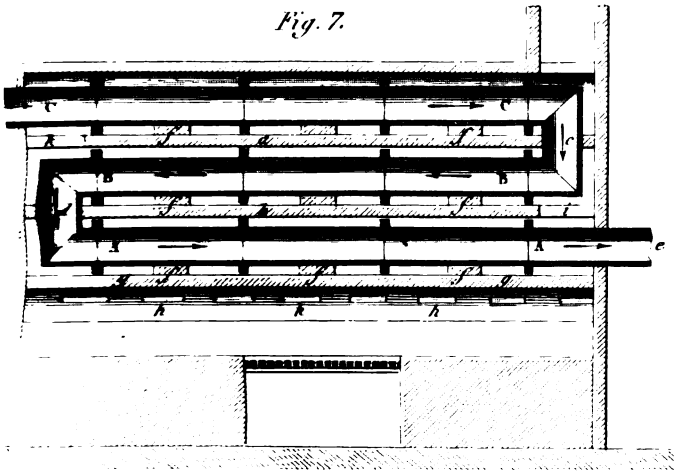


Fig. 8.

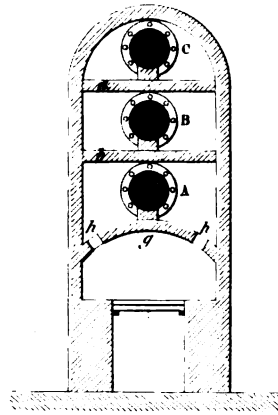


Fig. 9.

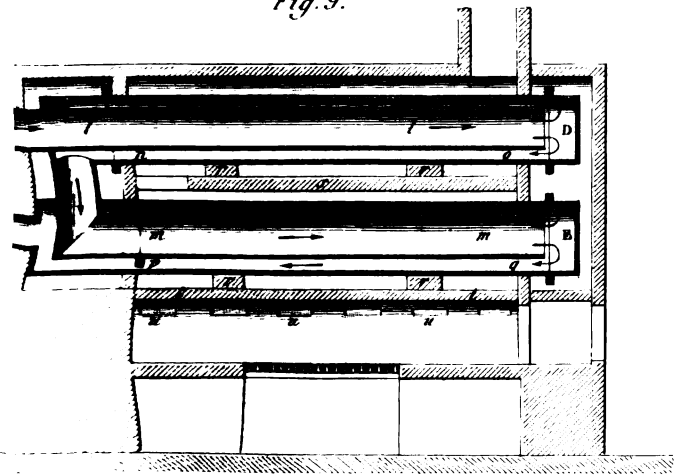


Fig. 10.

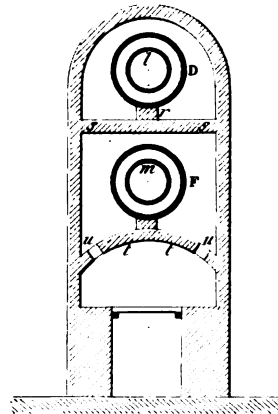


Fig. 11.

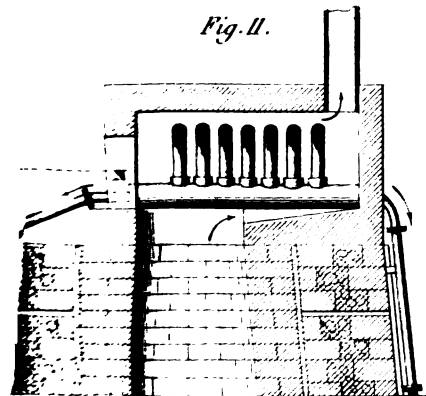
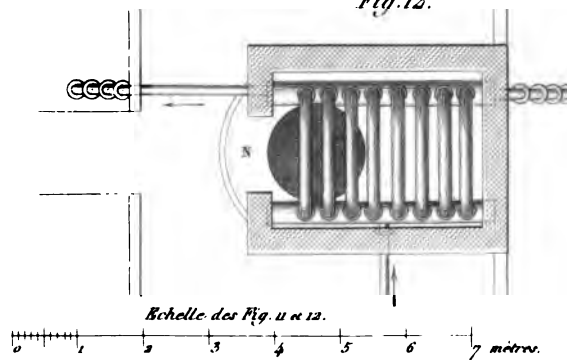


Fig. 12.



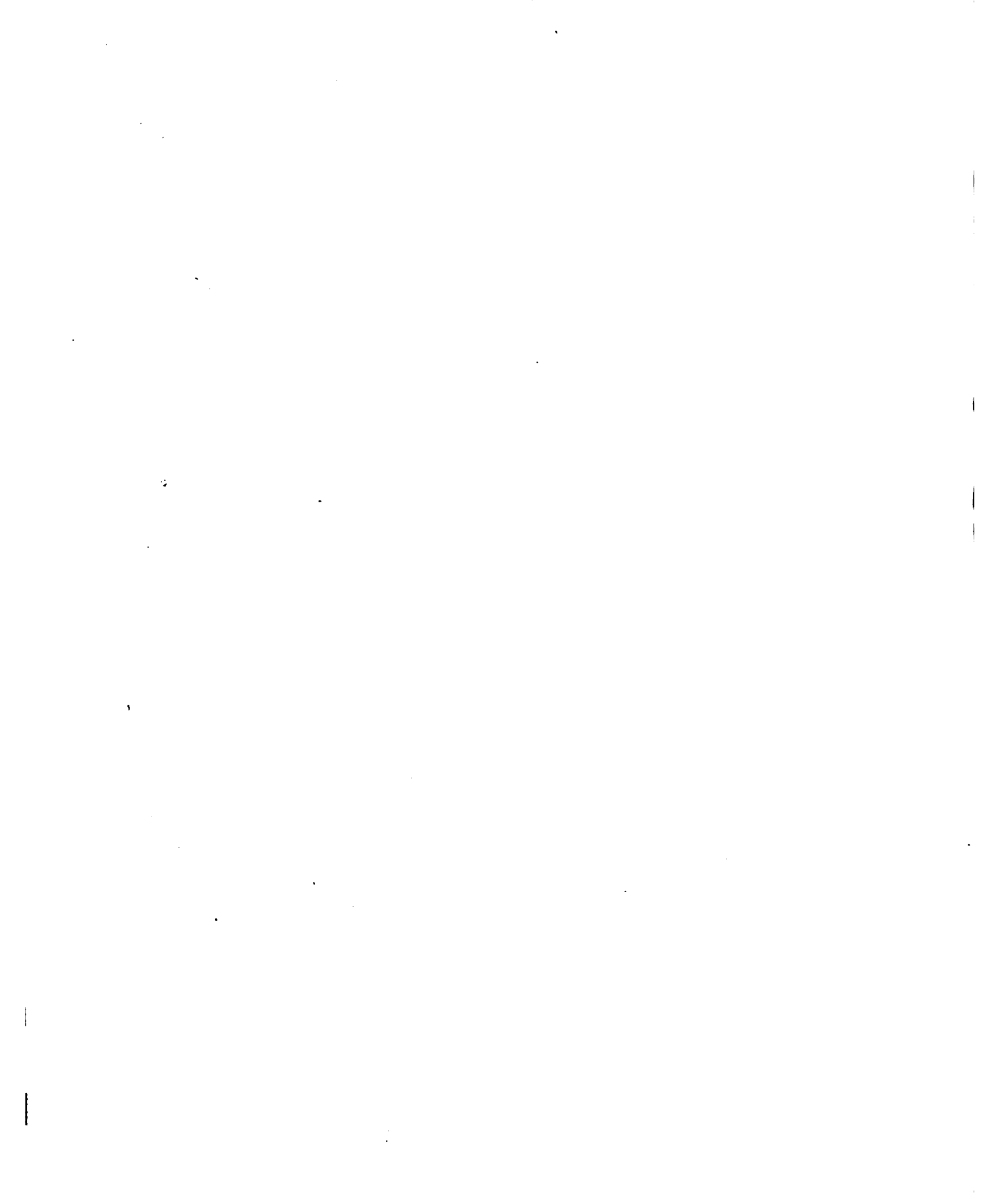


Fig. 1.



Fig. 4.

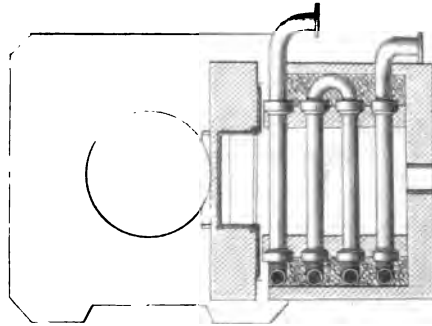


Fig. 6.

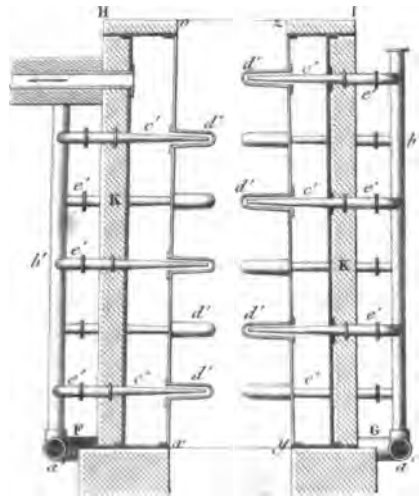


Fig. 8.

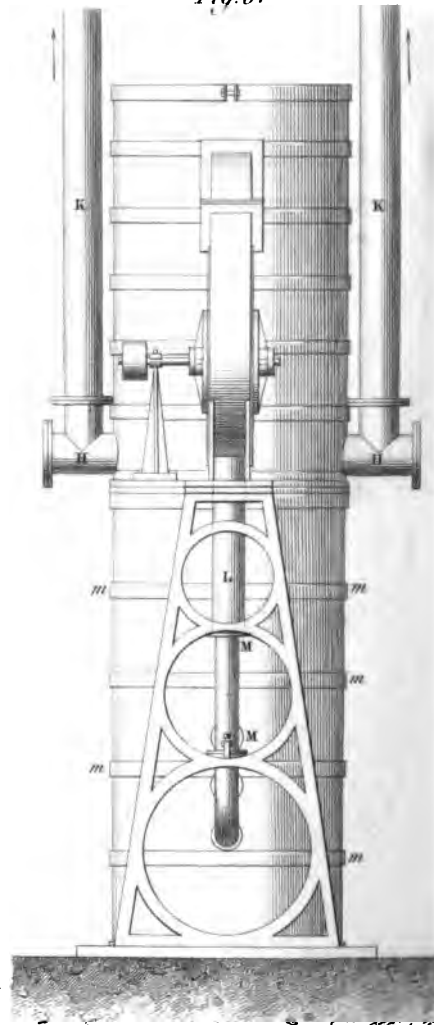
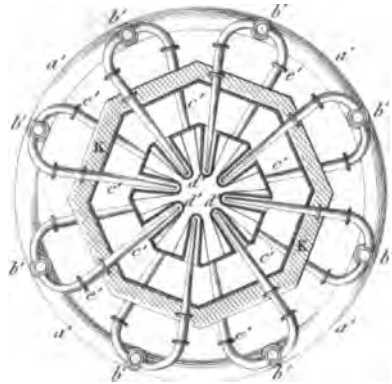
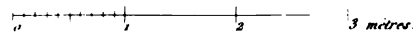


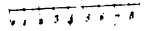
Fig. 7.



Echelle des Fig. 6 et 7.



Echelle de



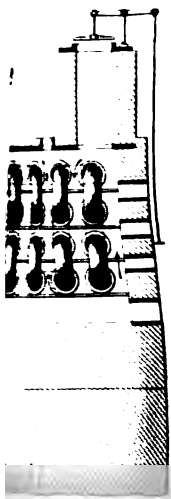


Fig. 3.

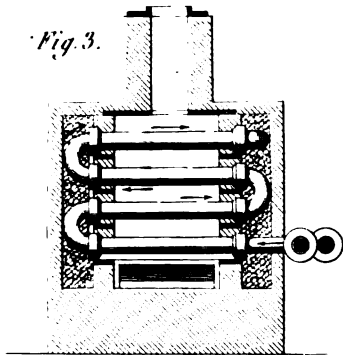


Fig. 5.

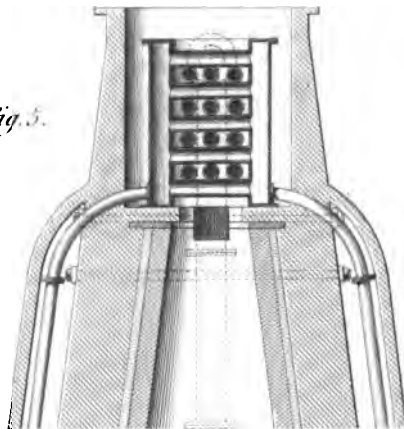


Fig. 9.

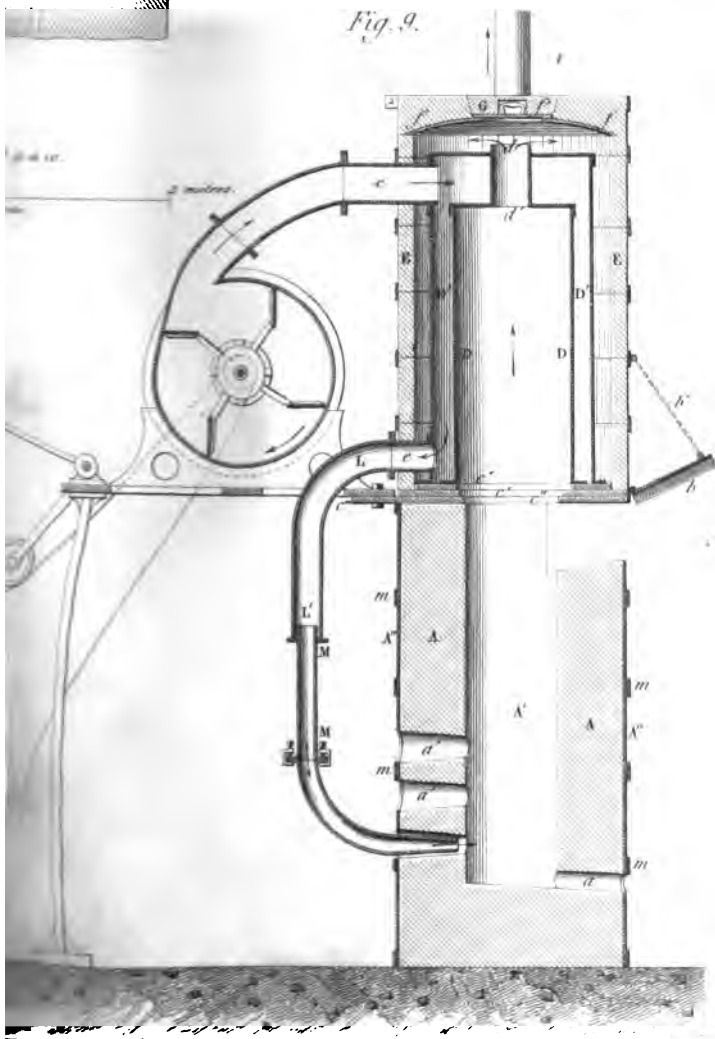
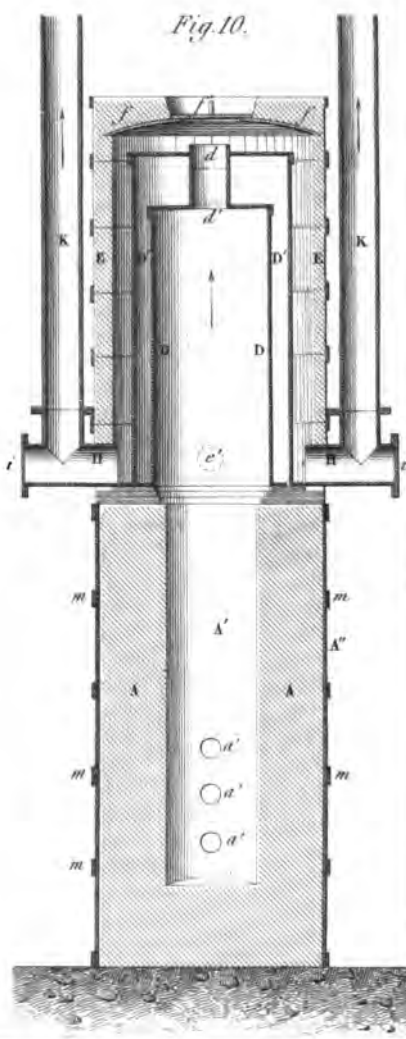
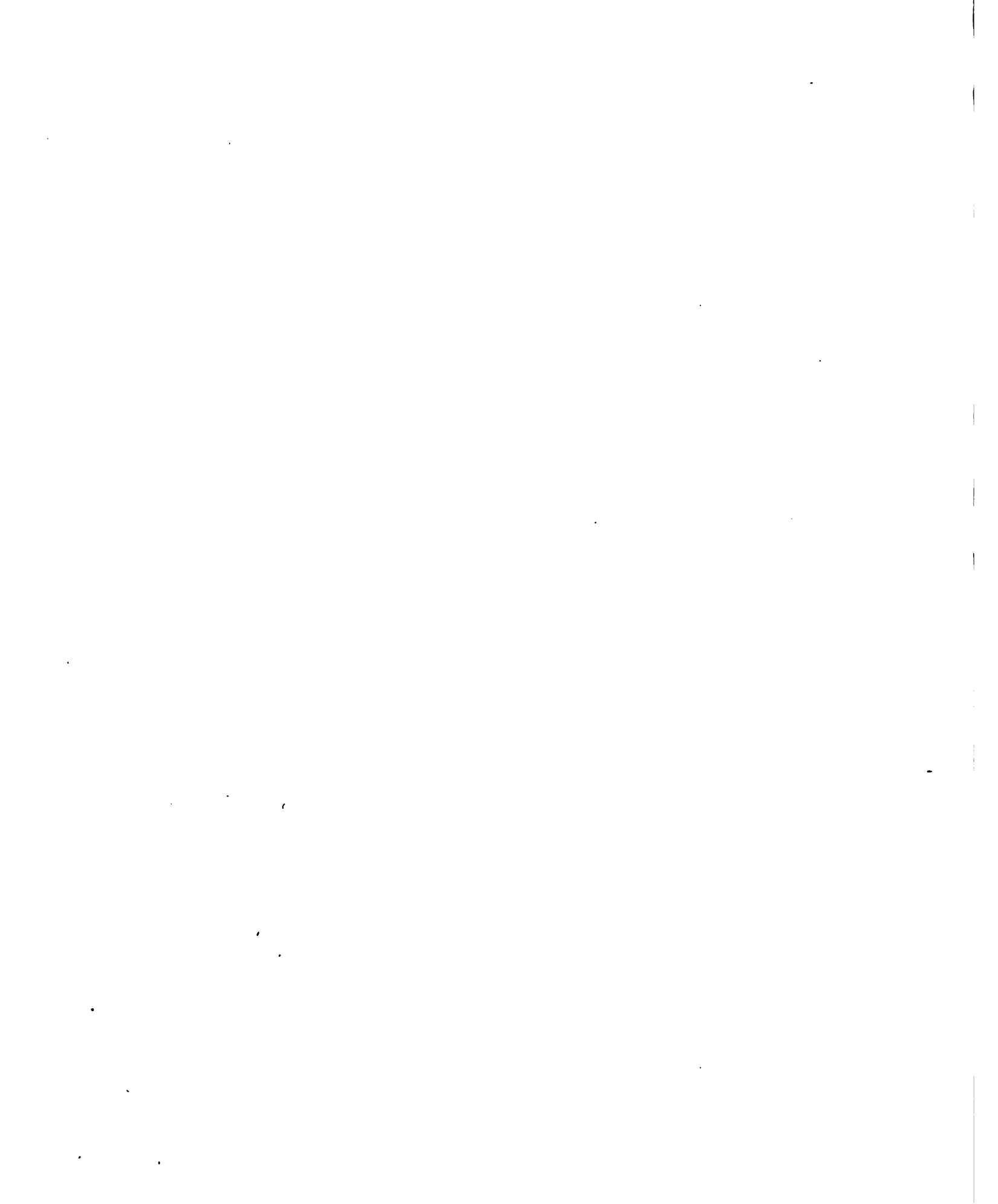
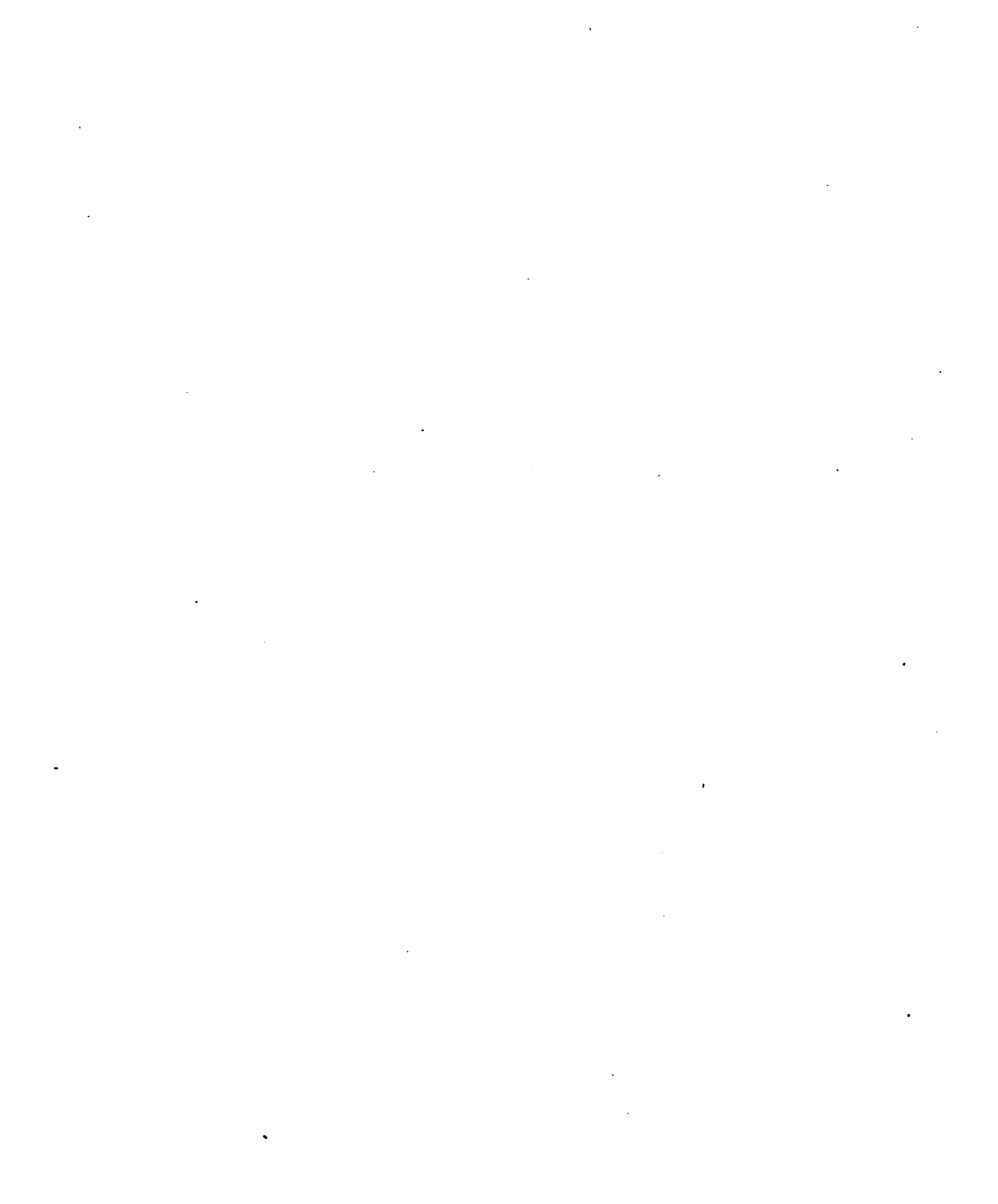
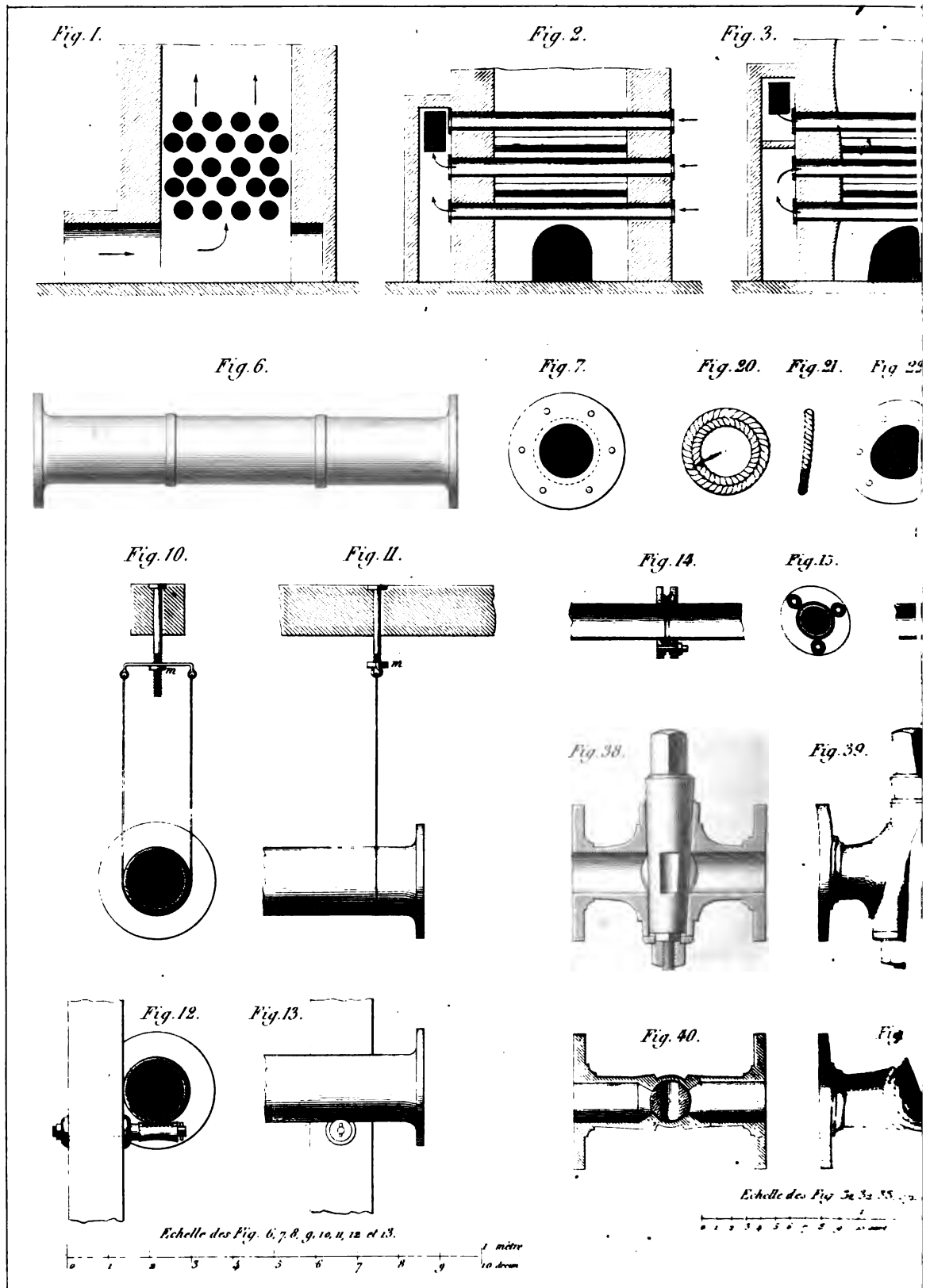


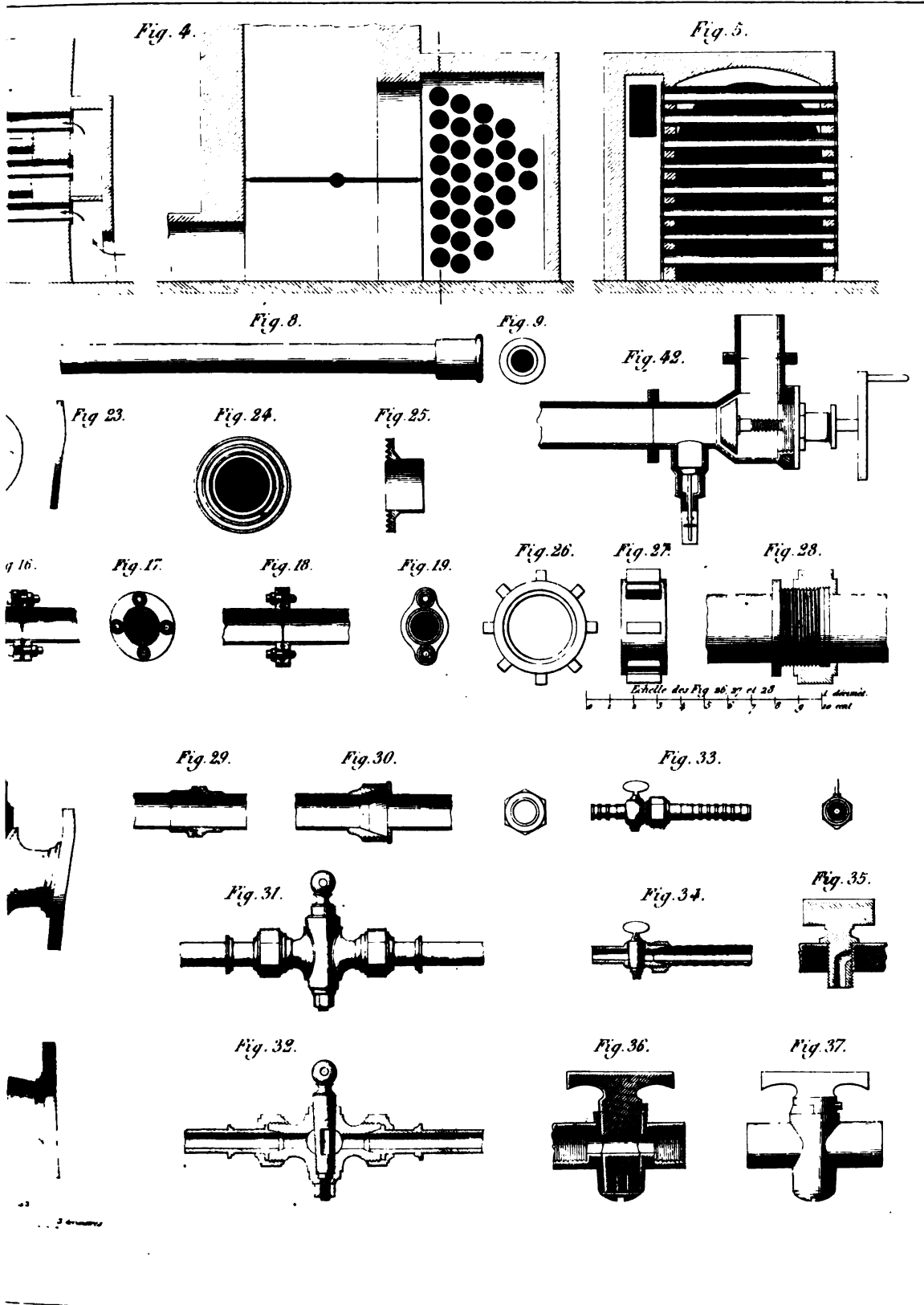
Fig. 10.

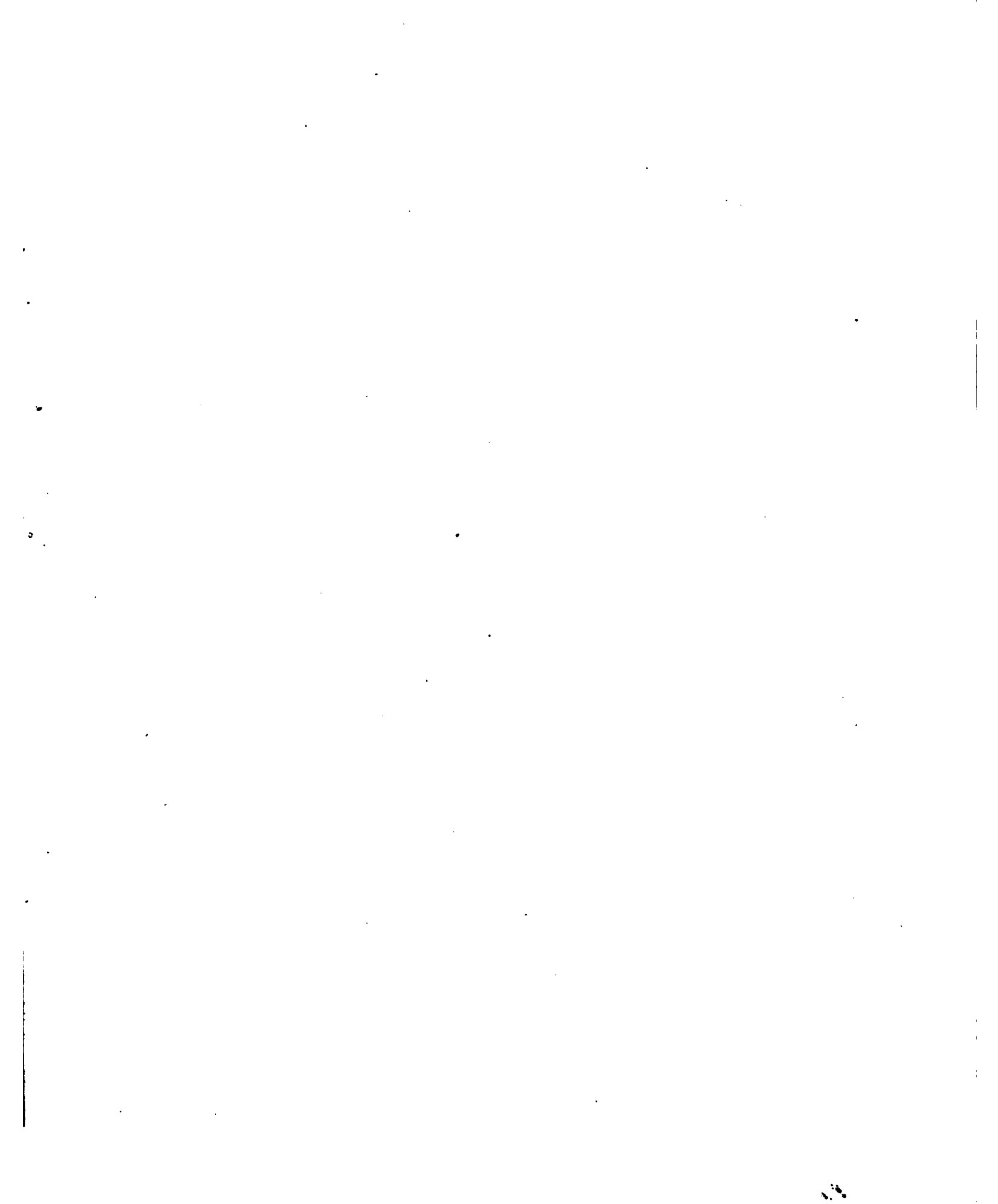




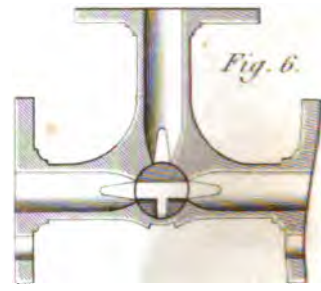
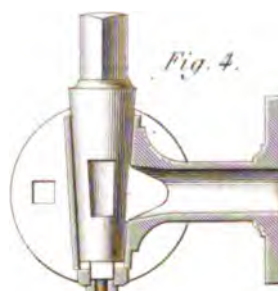
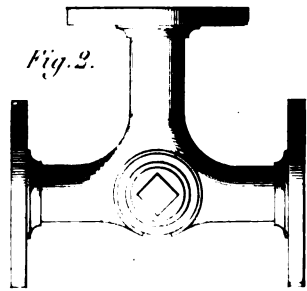
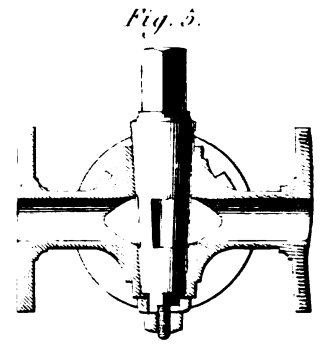
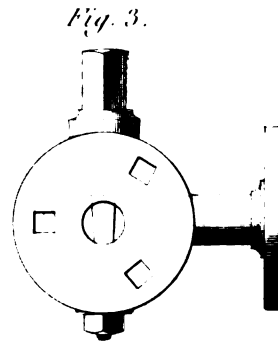
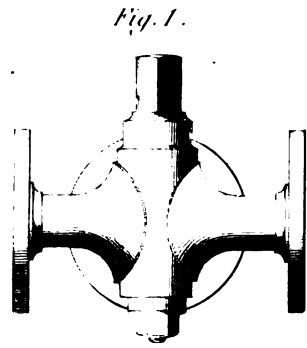




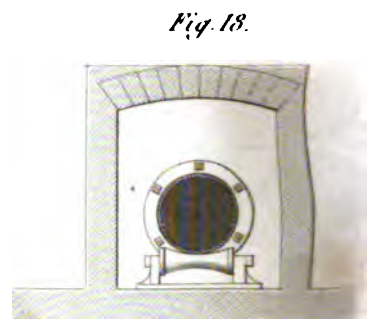
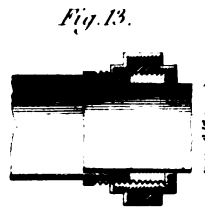
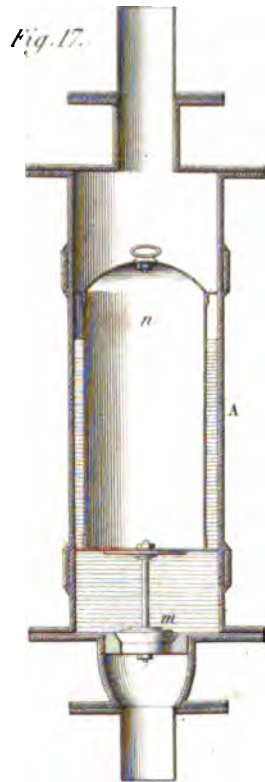




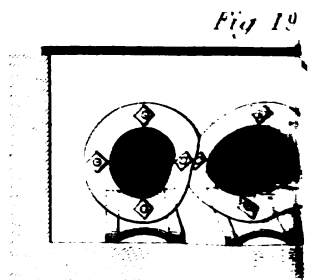
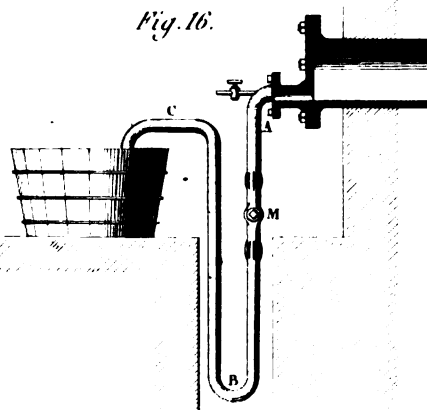


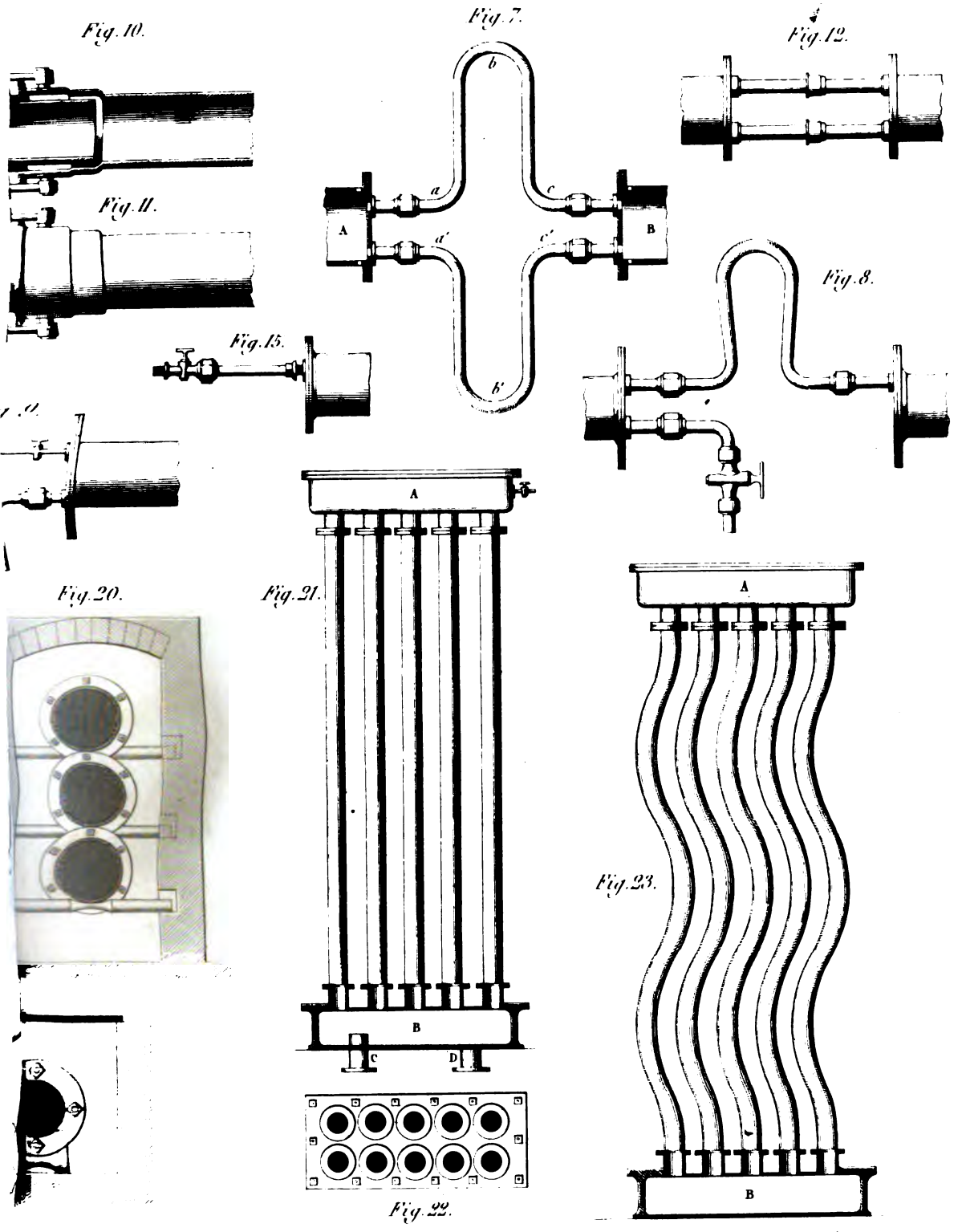


Echelle des Fig. 1, 2, 3, 4, 5 et 6.
 0 1 2 3 4 5 6 7 8 9 10 cent. 2 décim.

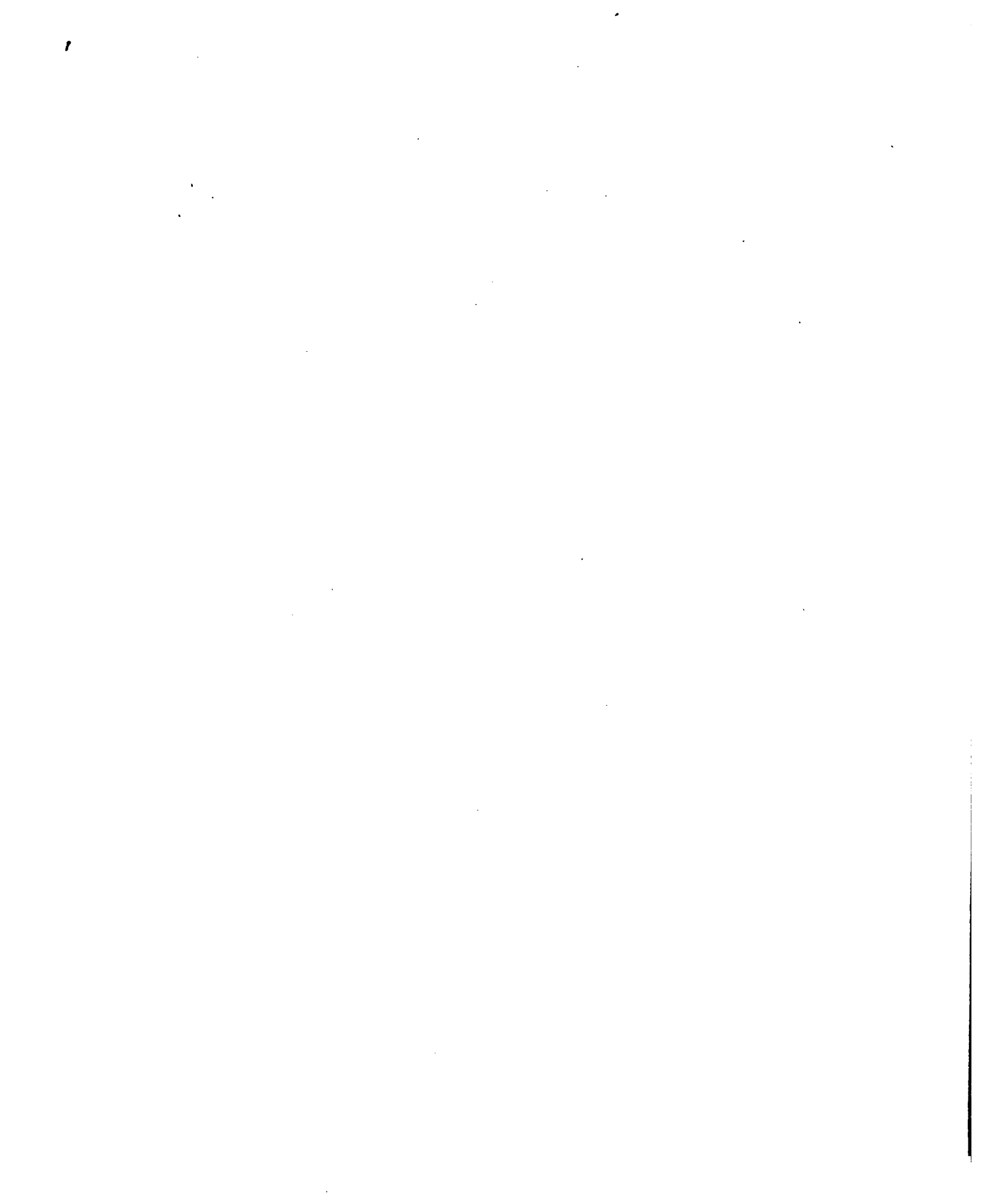


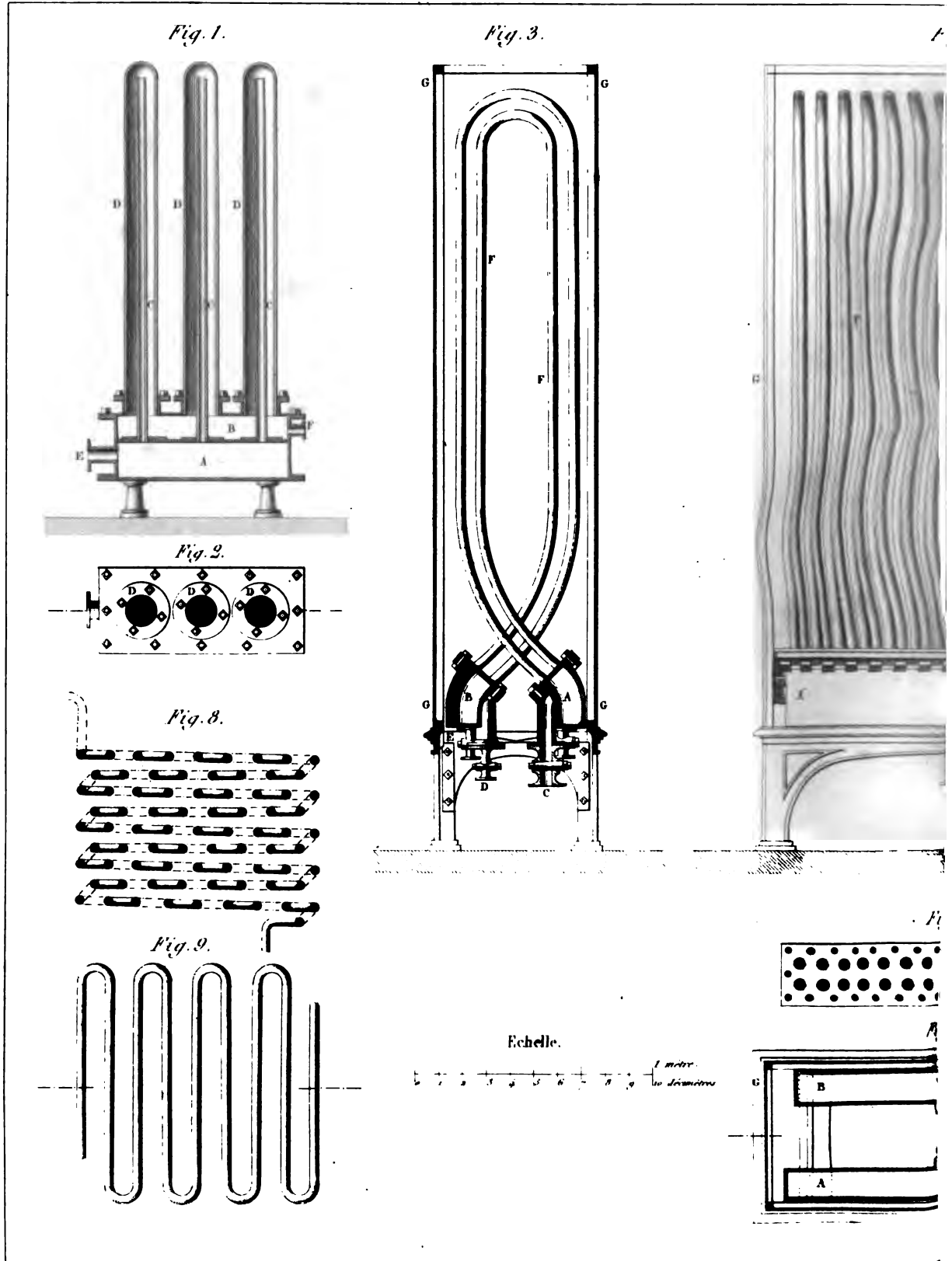
Echelle des Fig. 18, 19 et 20.
 0 1 2 3 4 5 6 7 8 9 10 cent. 2 décim.

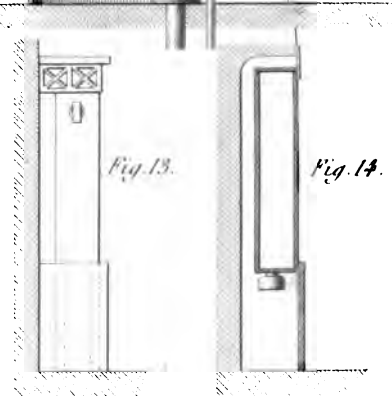
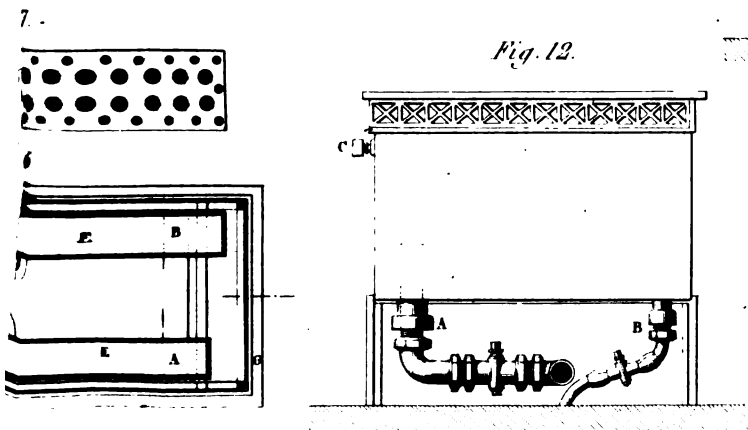
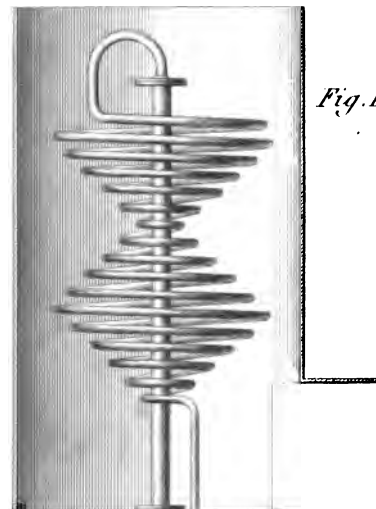
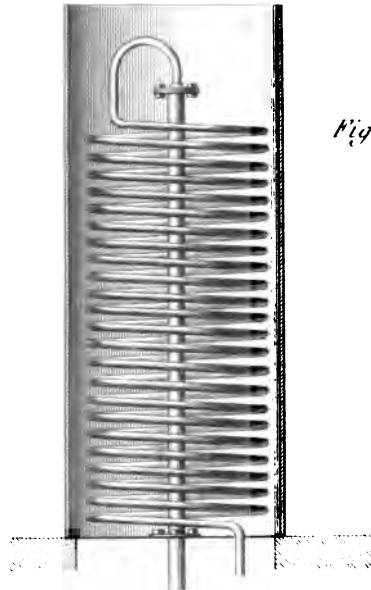
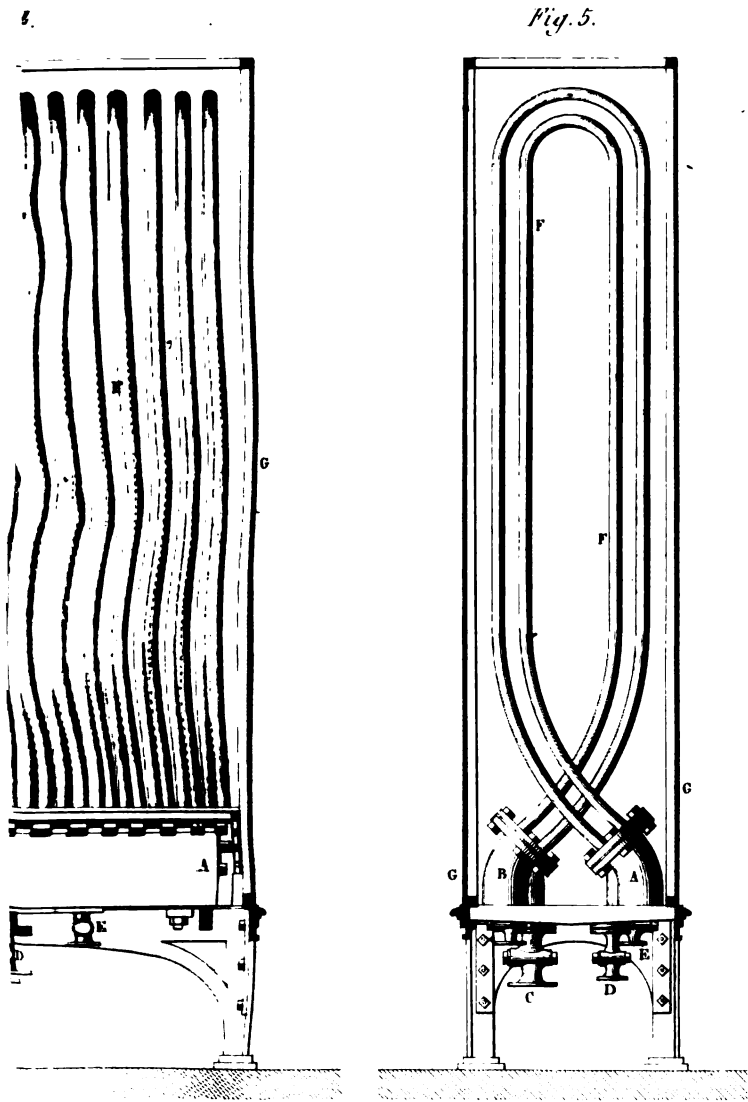


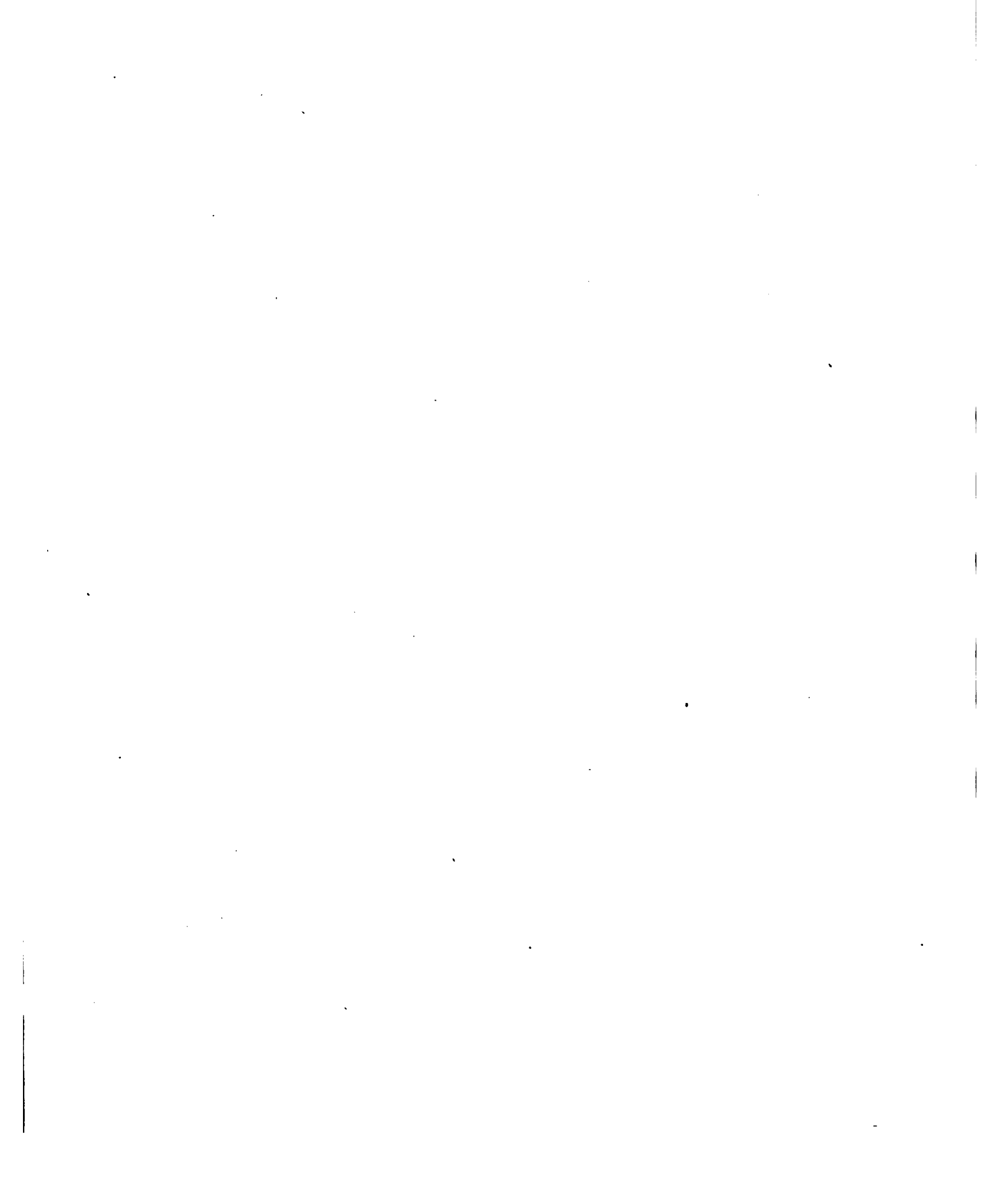


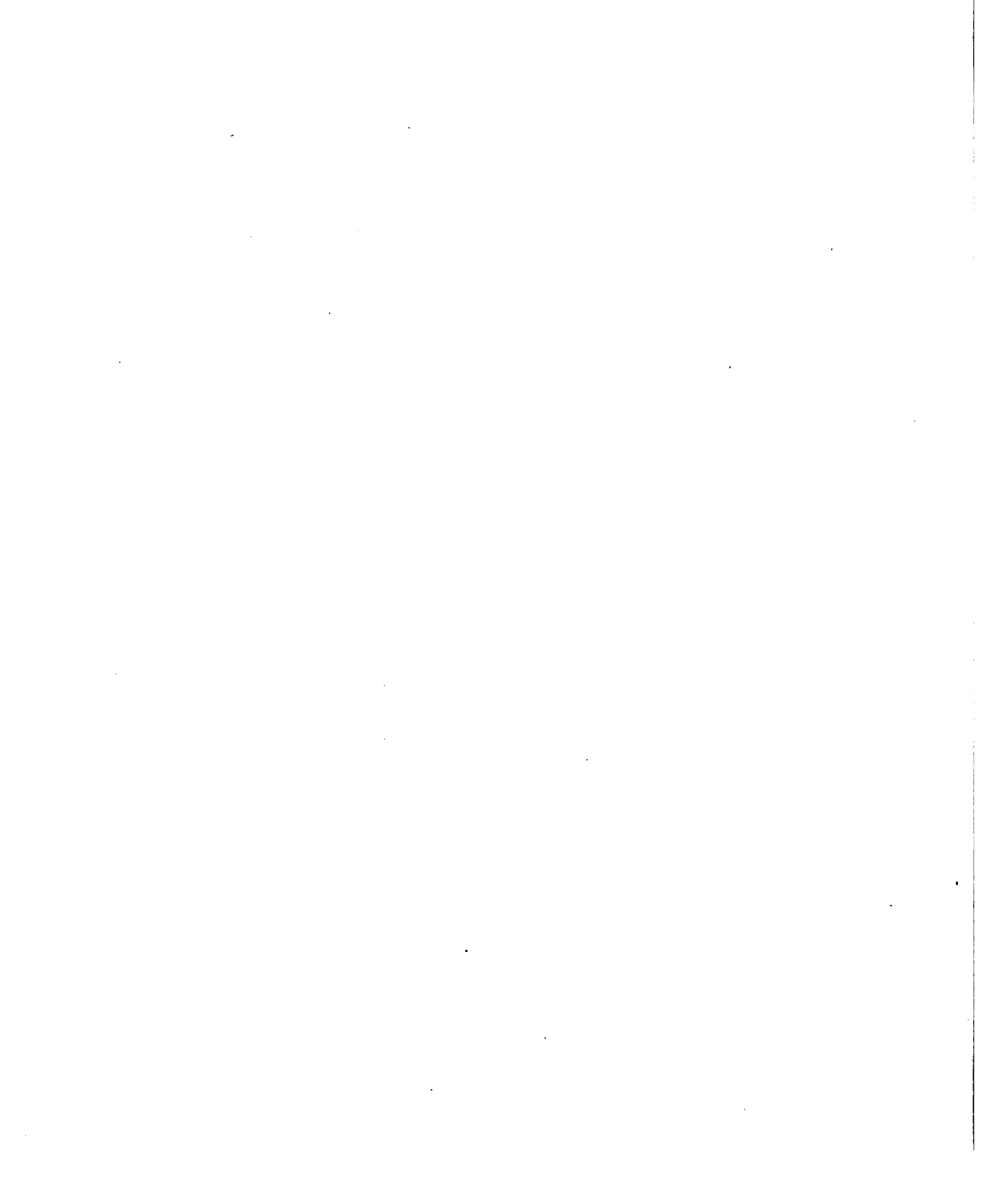


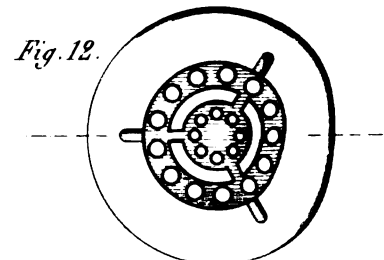
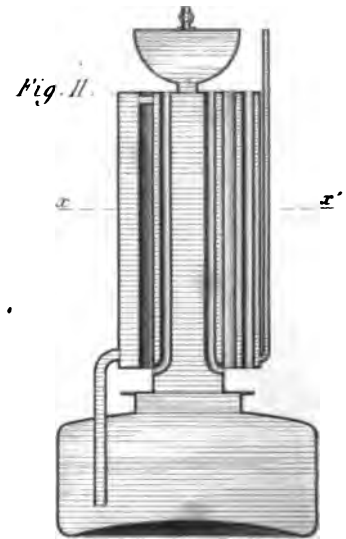
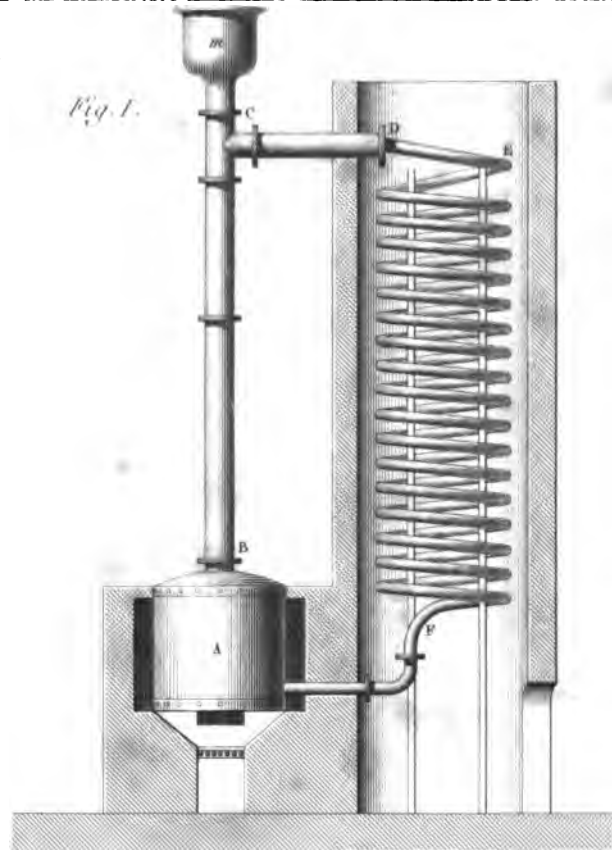












Echelle des Fig. 11 et 12.
 1 2 3 4 5 6 7 8 9

Fig. 2.



Fig. 4.

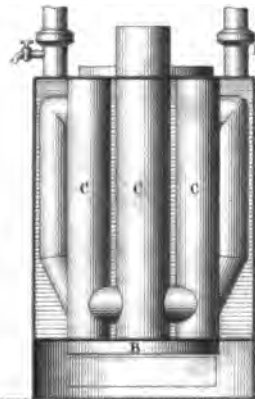


Fig. 6.

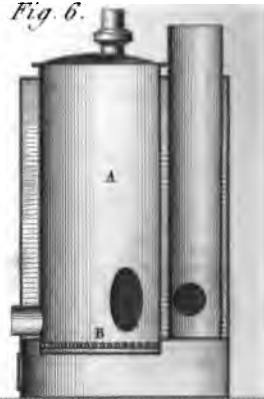


Fig.



Fig. 3.

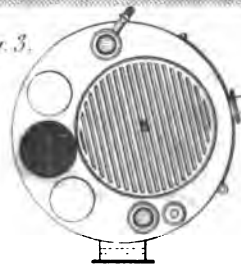


Fig. 5.

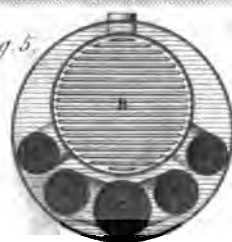


Fig. 7.

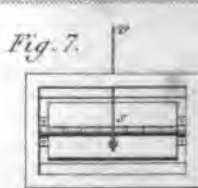


Fig. 8.



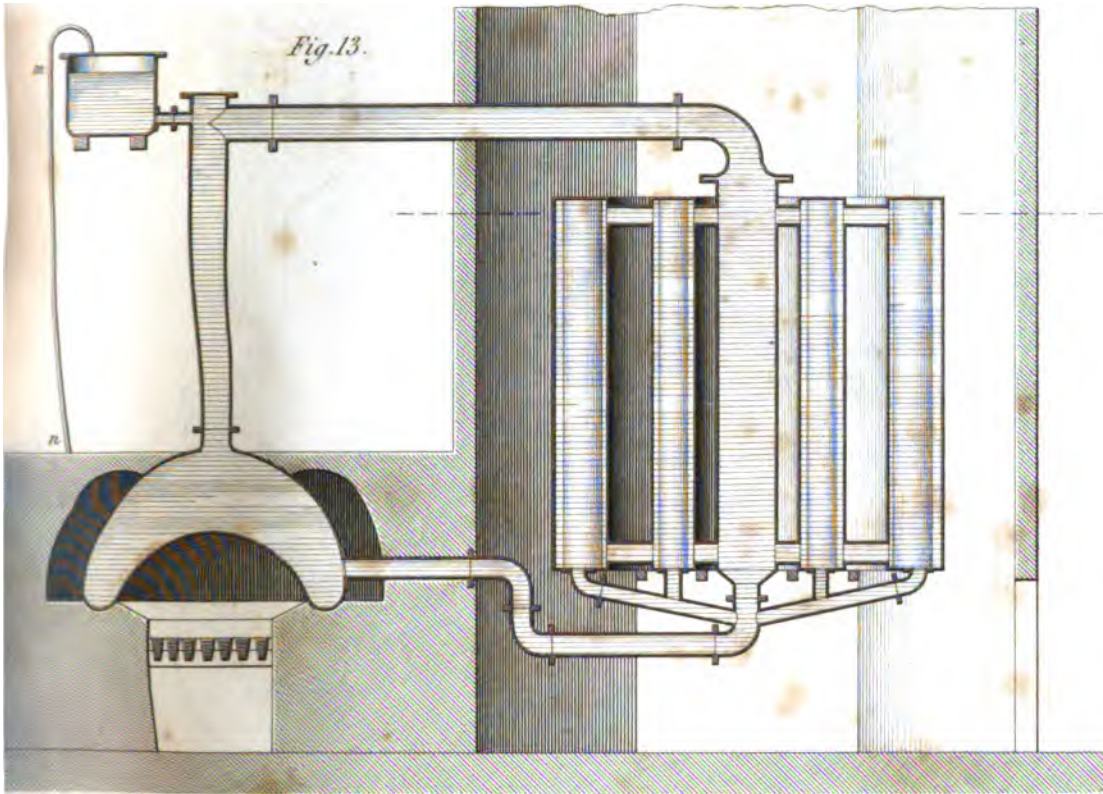


Fig. 10.

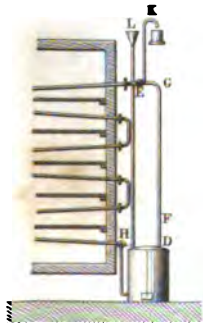
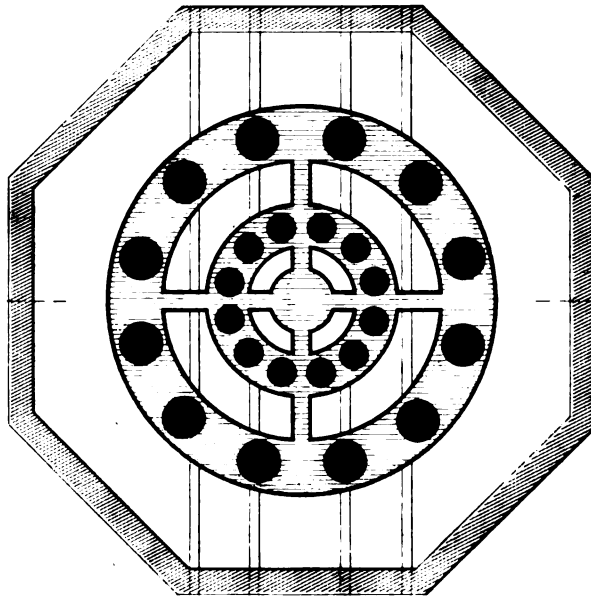


Fig. 14.

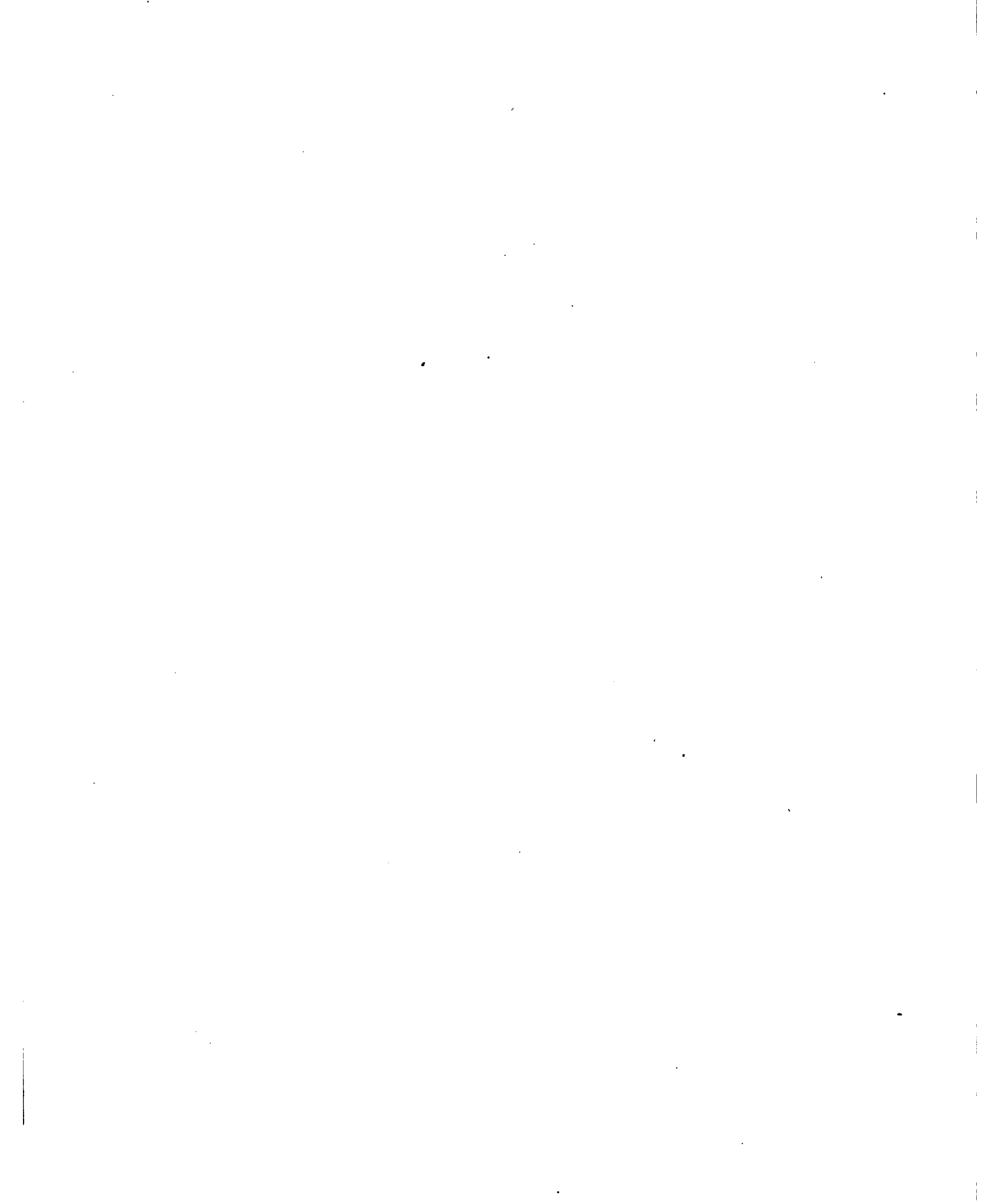


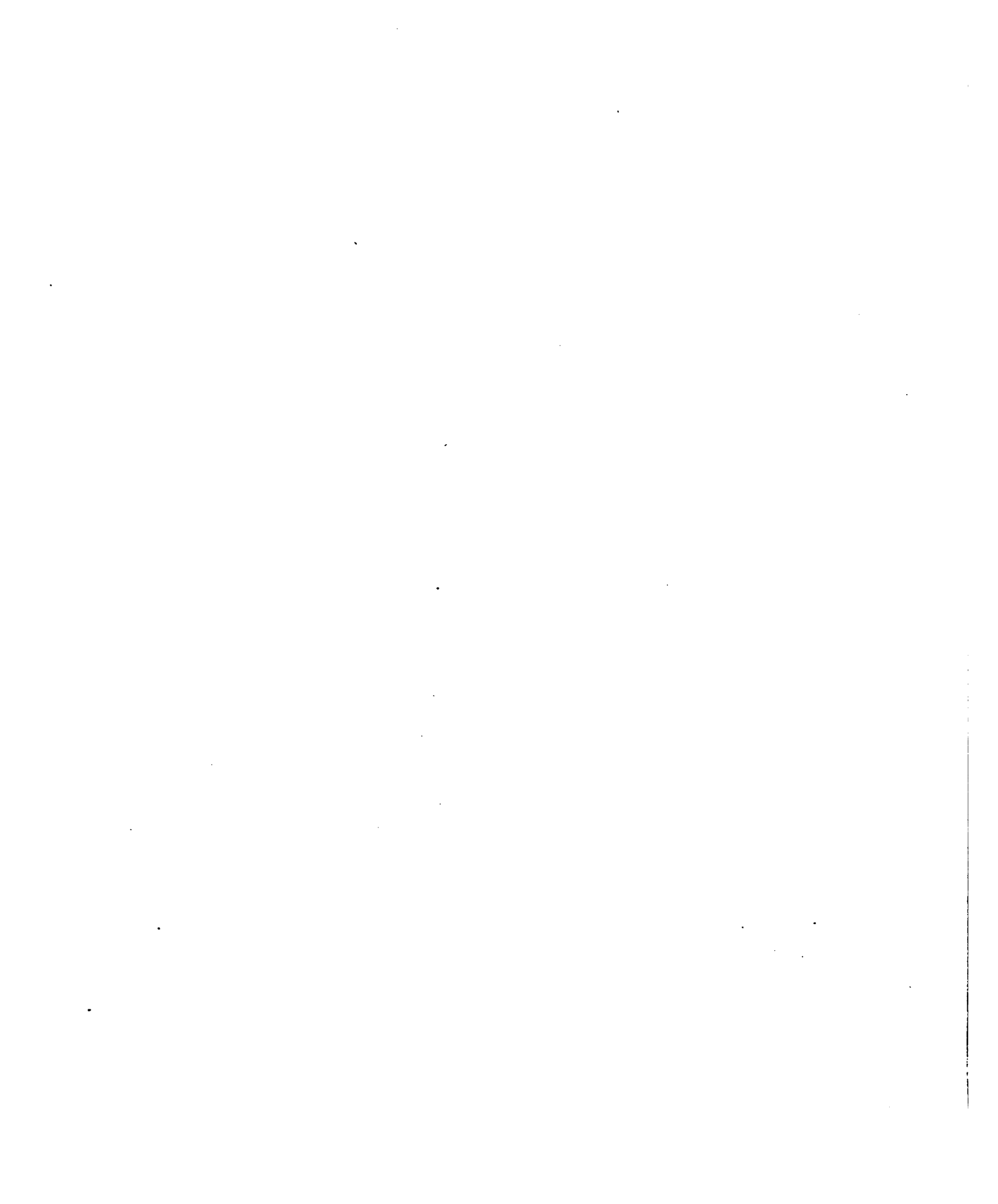
Echelle des Fig. 2, 3, 4, 5 et 6.

1 mètre.

Echelle des Fig. 8 et 9.

5 décimètres.





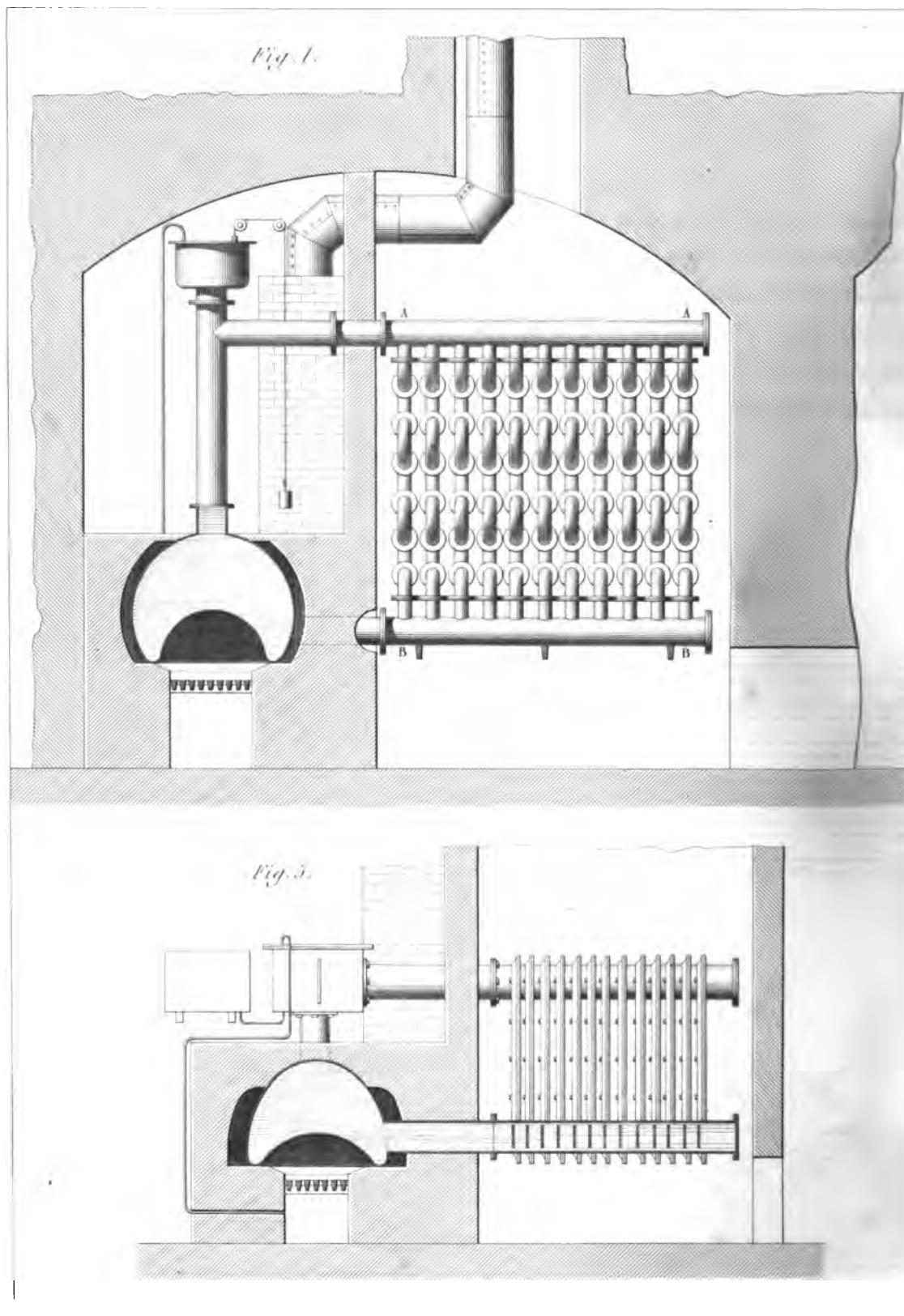


Fig. 2.

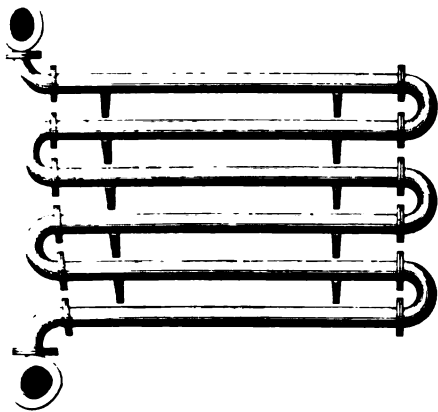


Fig. 3.

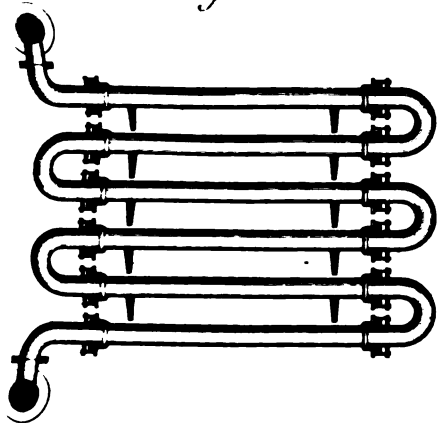


Fig. 4.

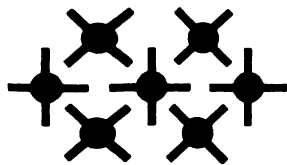


Fig. 6.

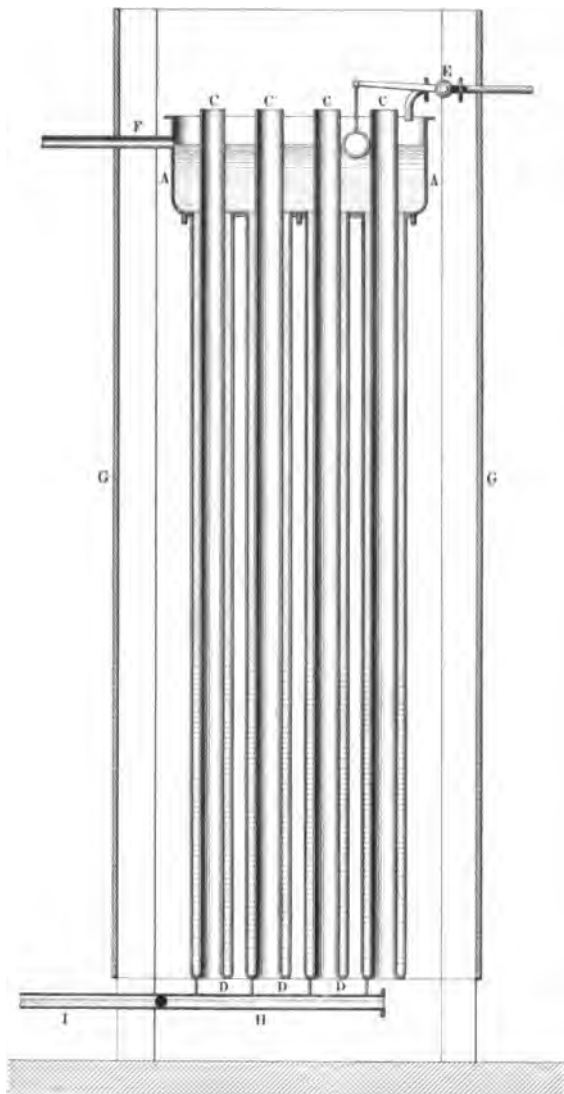
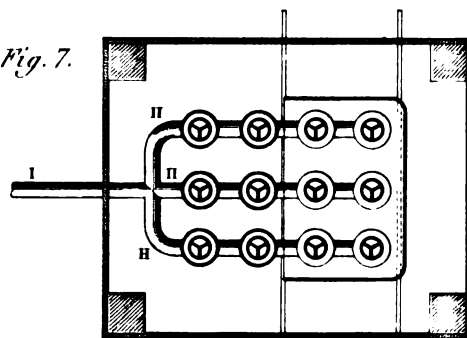
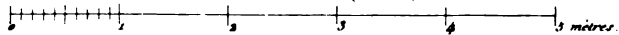
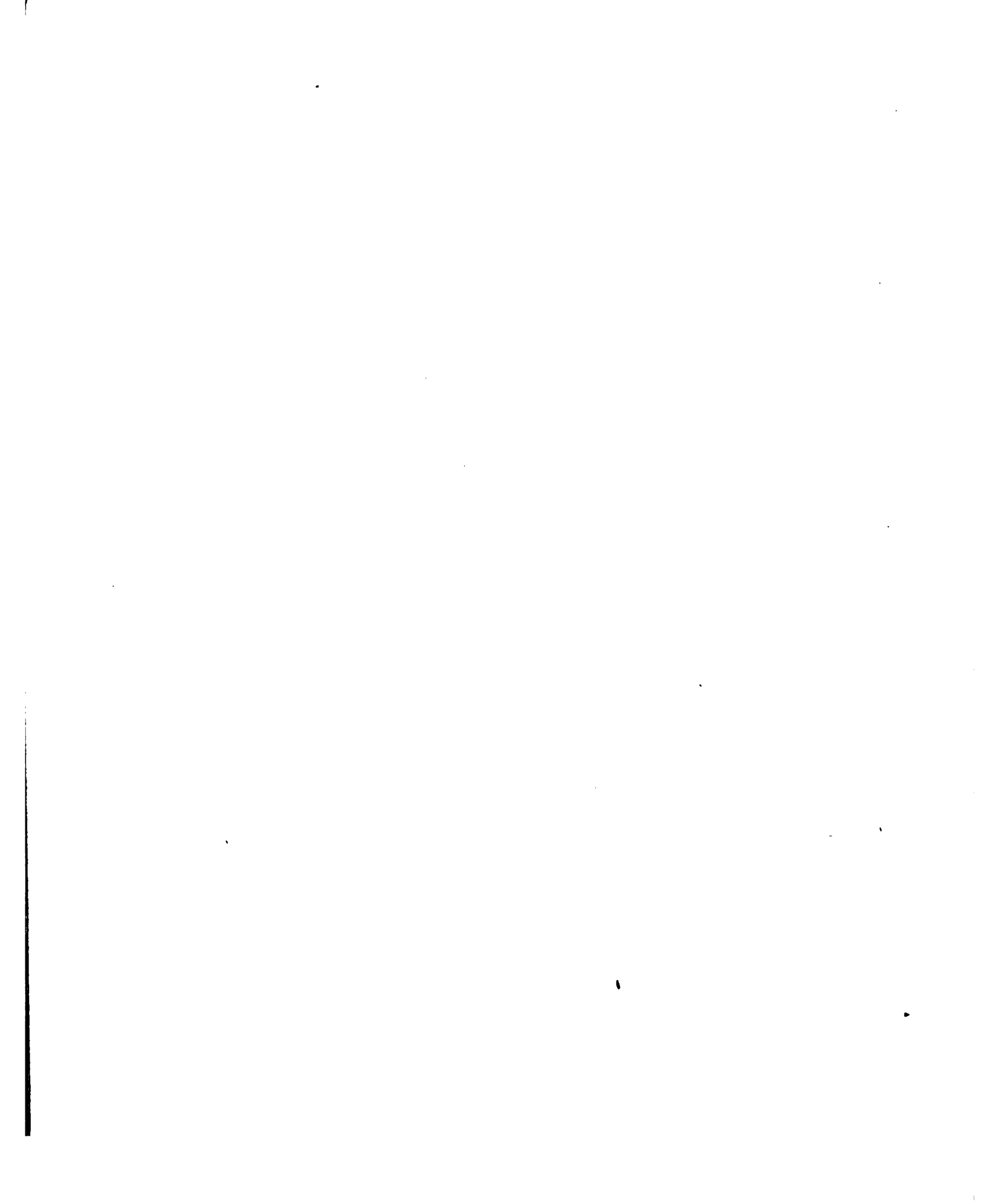


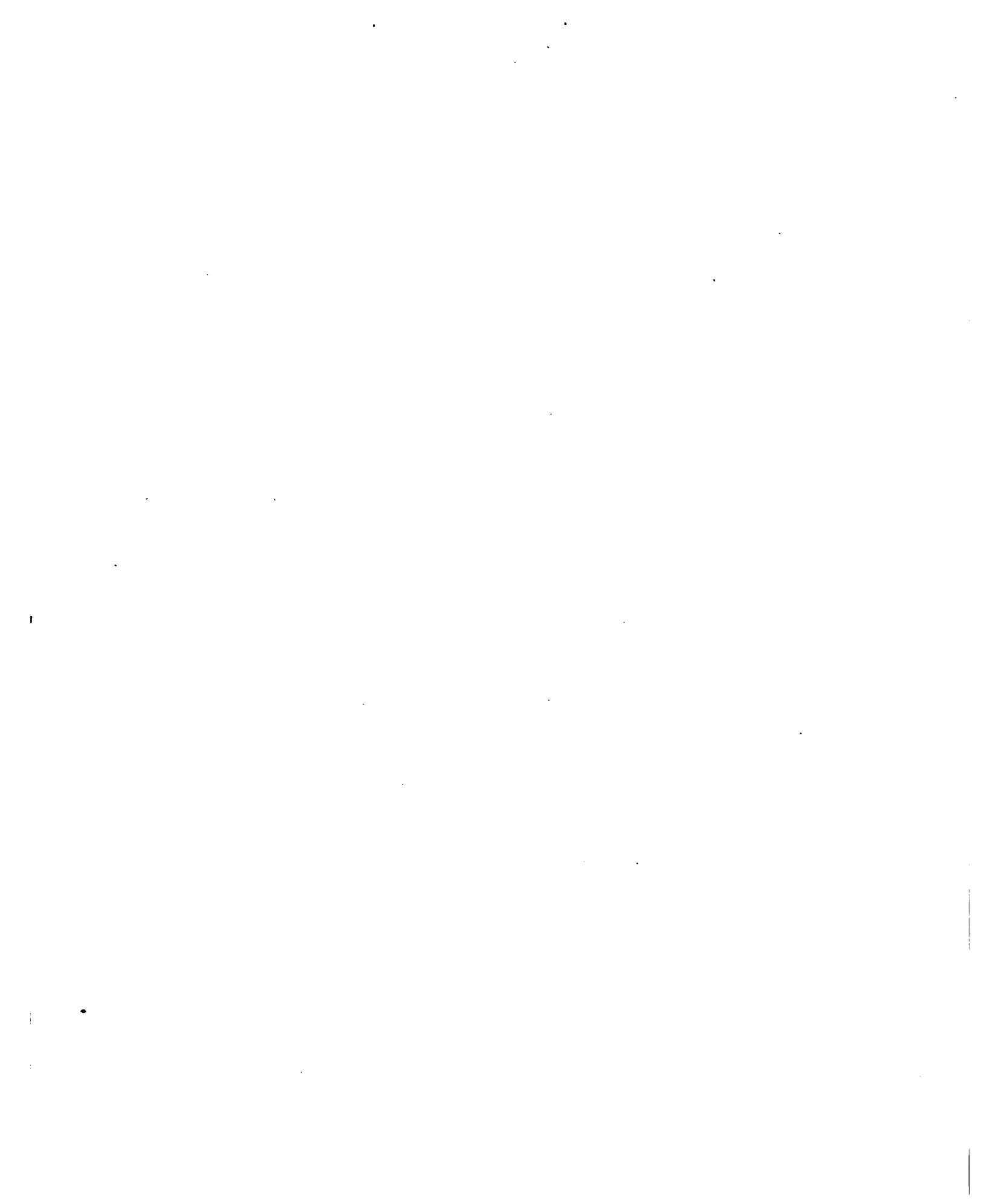
Fig. 7.

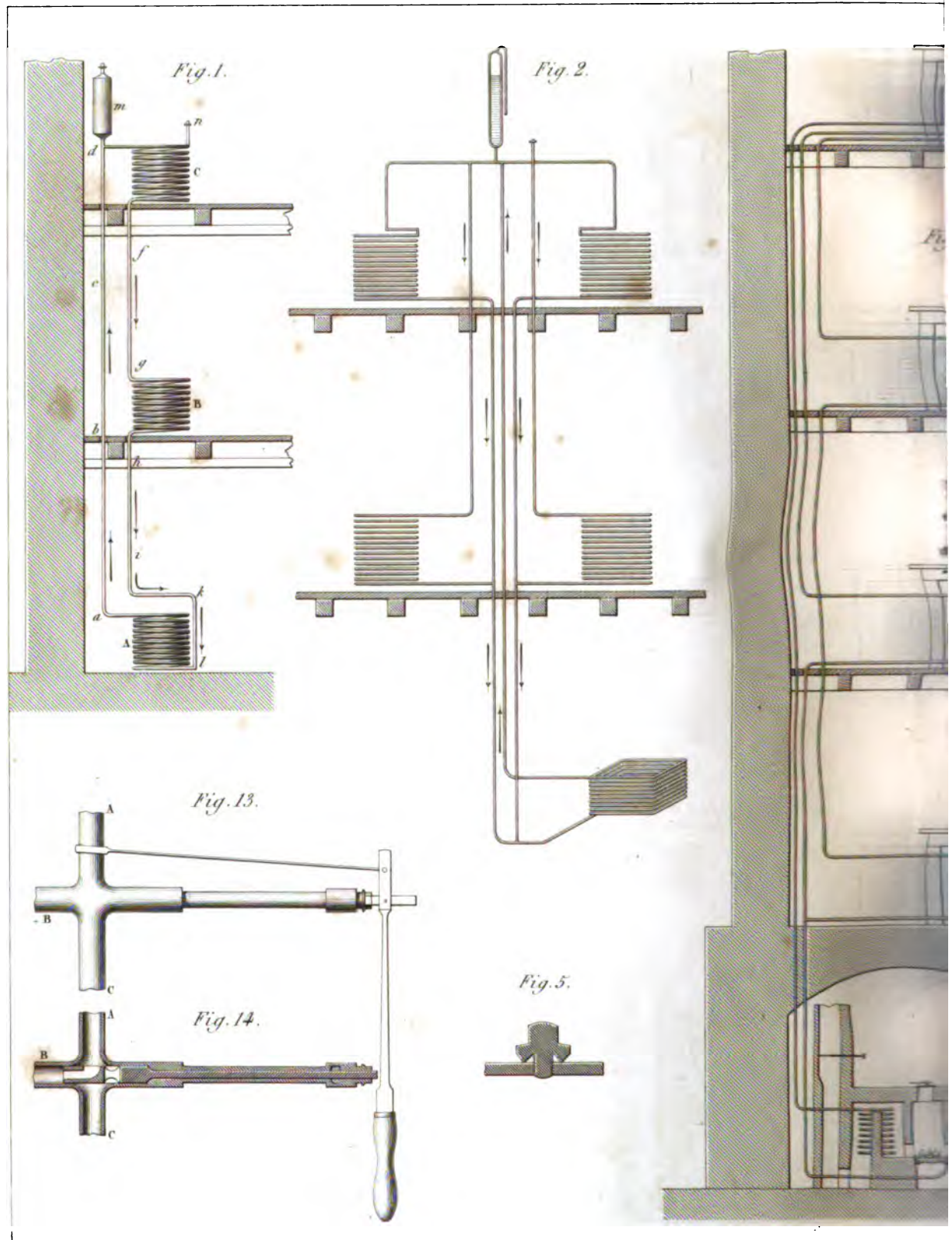


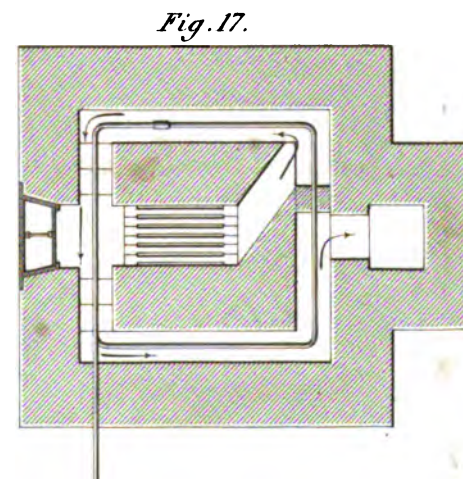
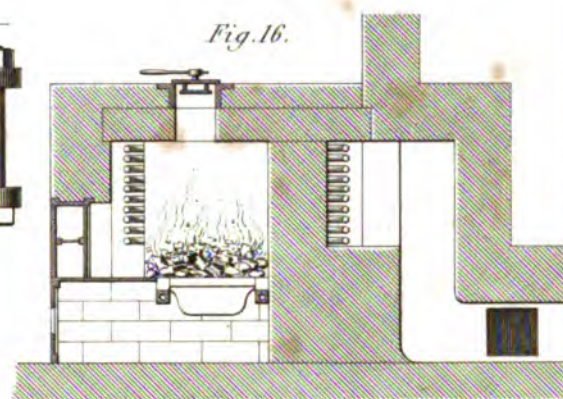
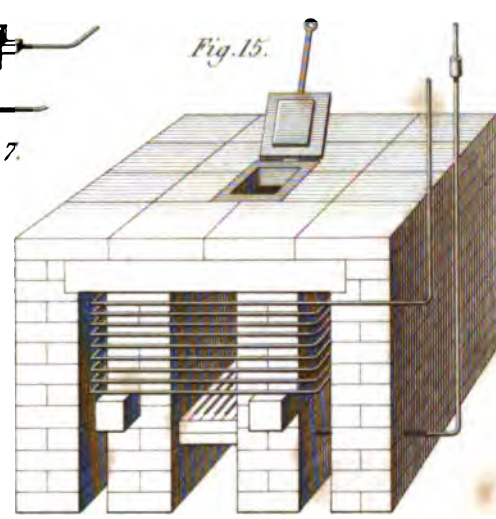
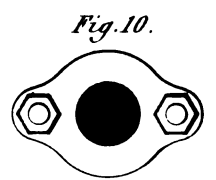
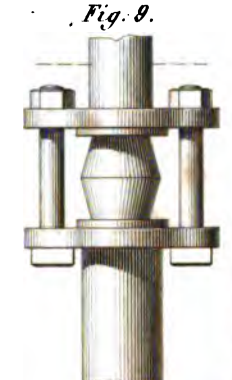
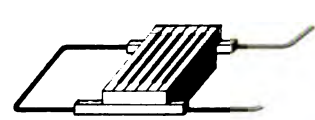
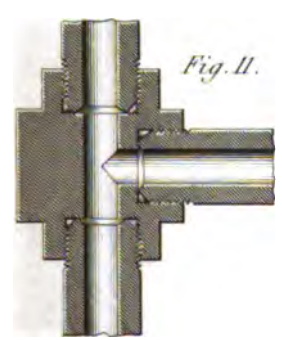
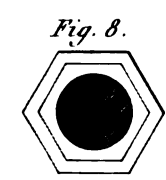
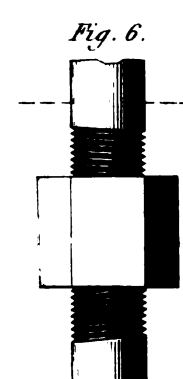
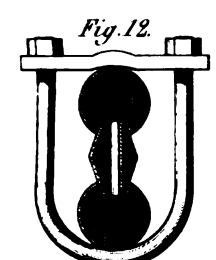
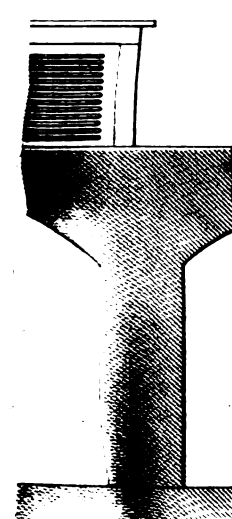
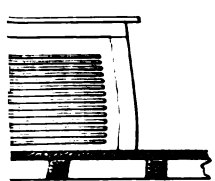
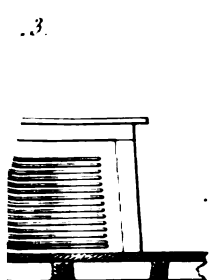
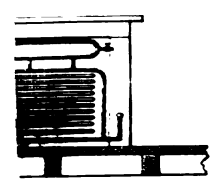
Echelle des Fig. 6 et 7.



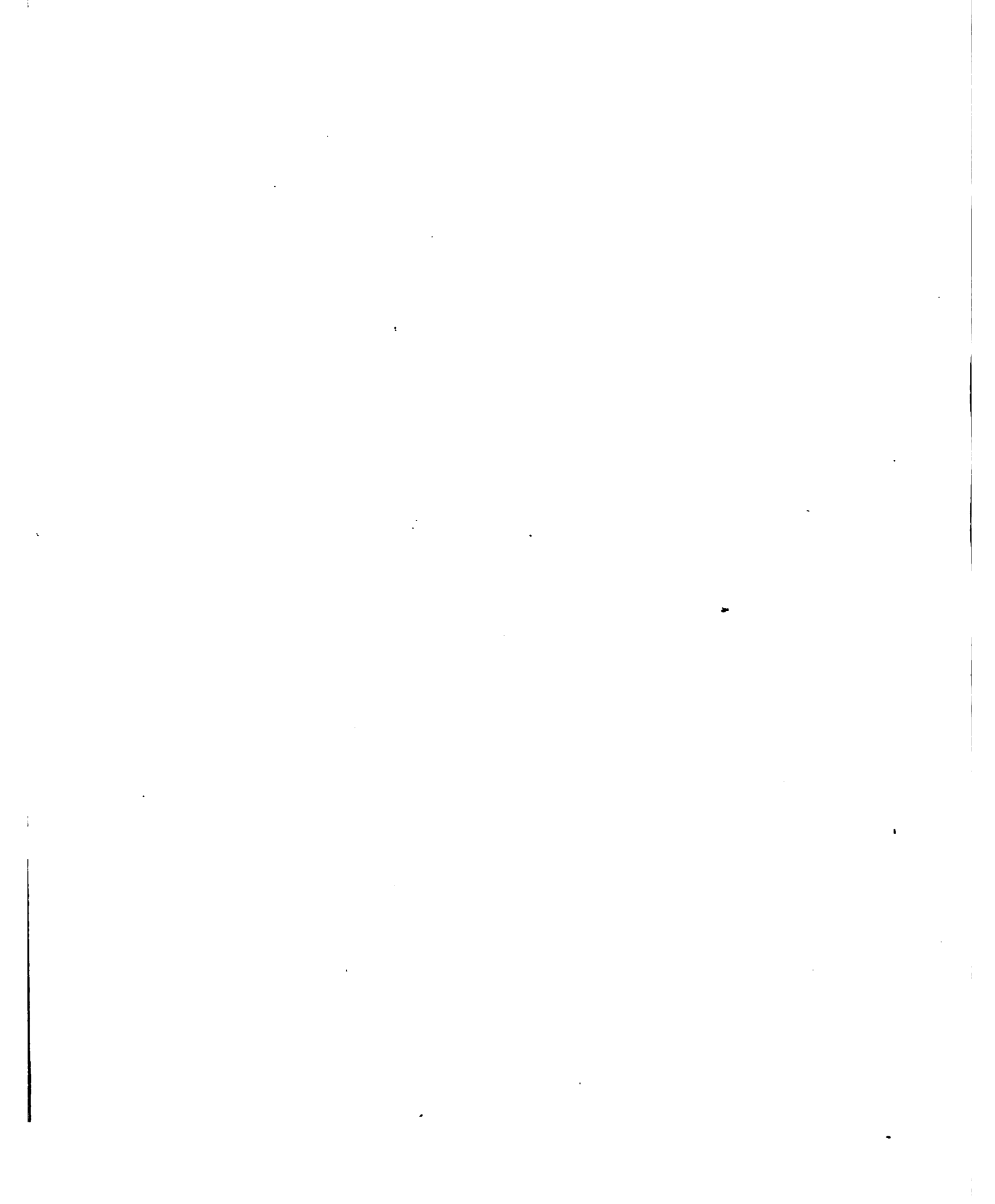




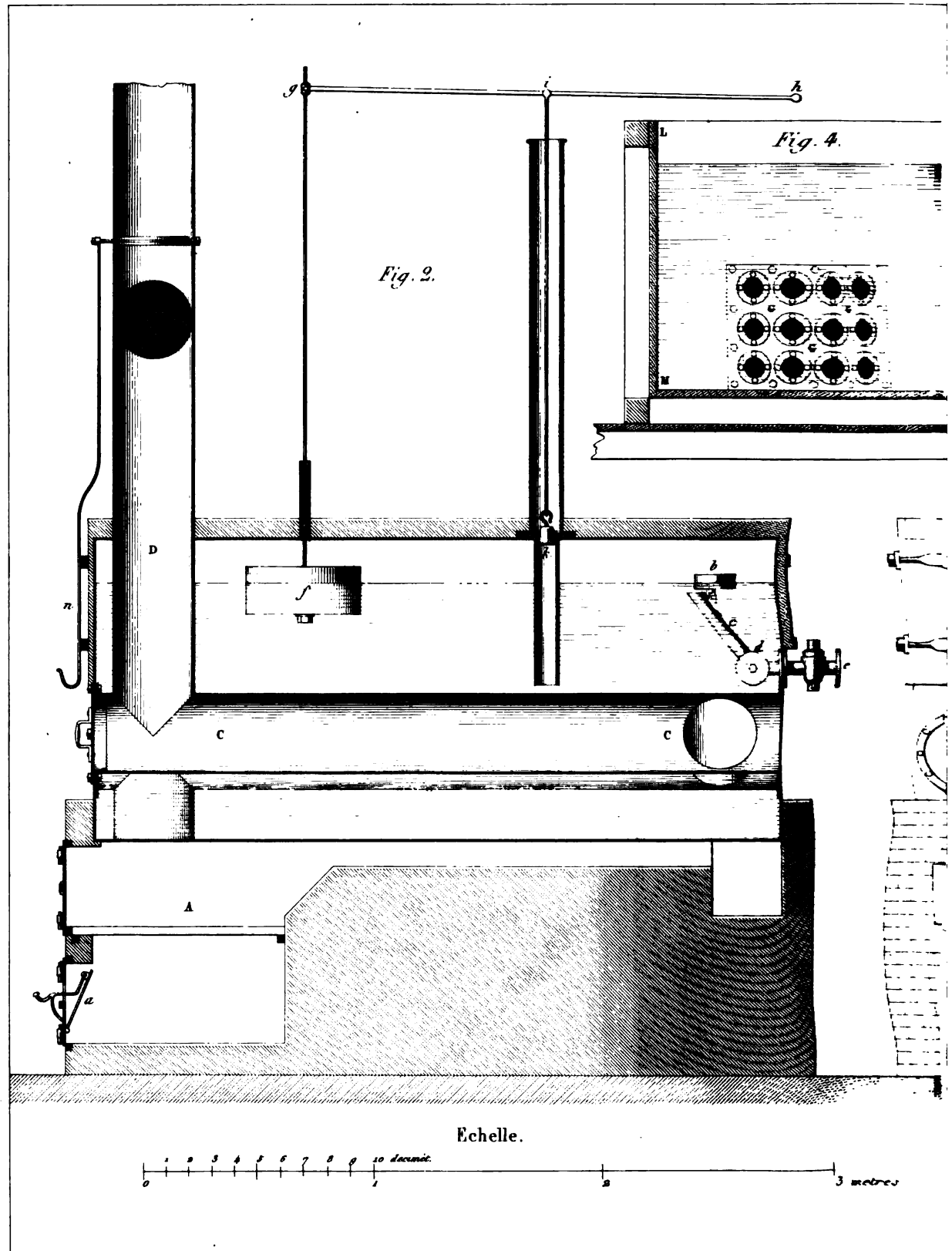


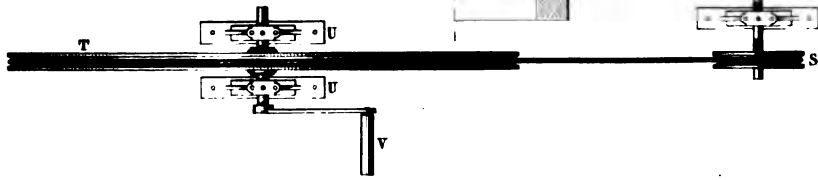
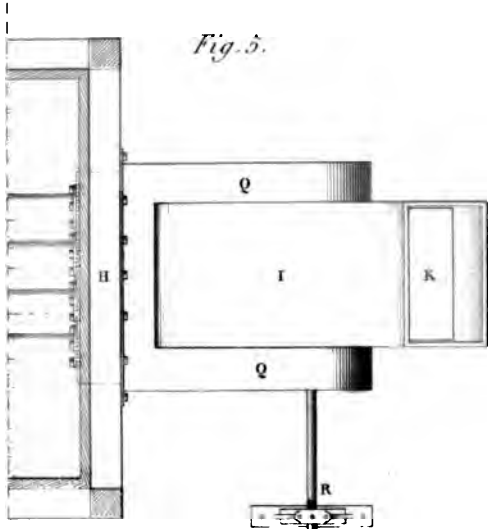
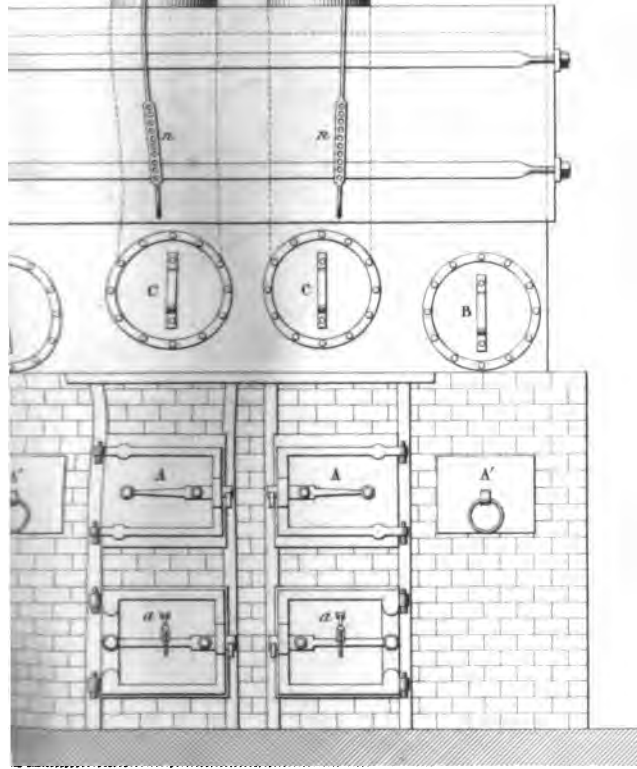
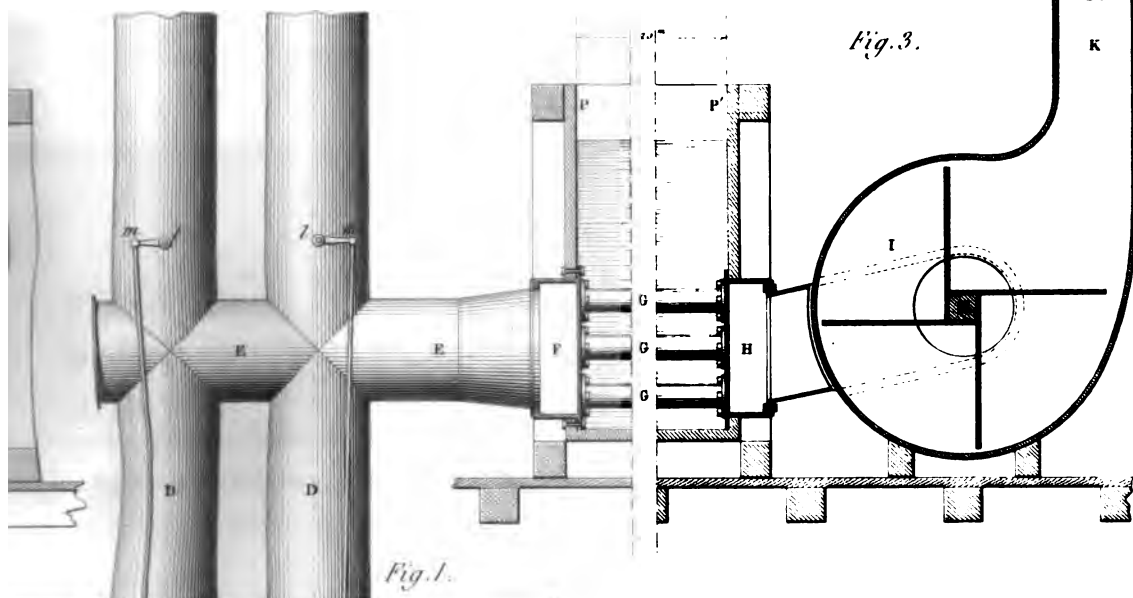


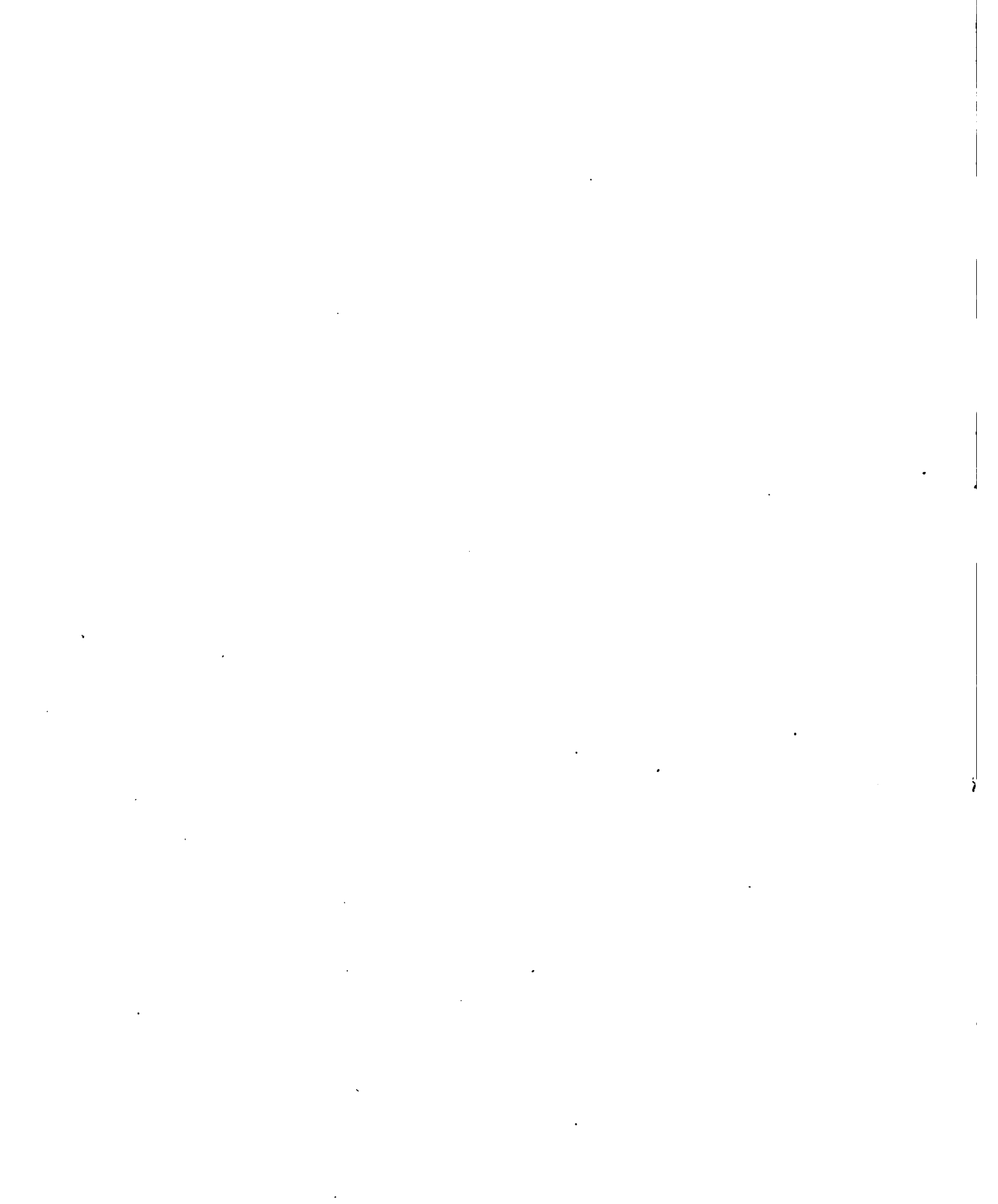
Echelle des Fig. 15, 16 et 17.
0 1 2 3 4 5 6 7 8 9 10 cent.

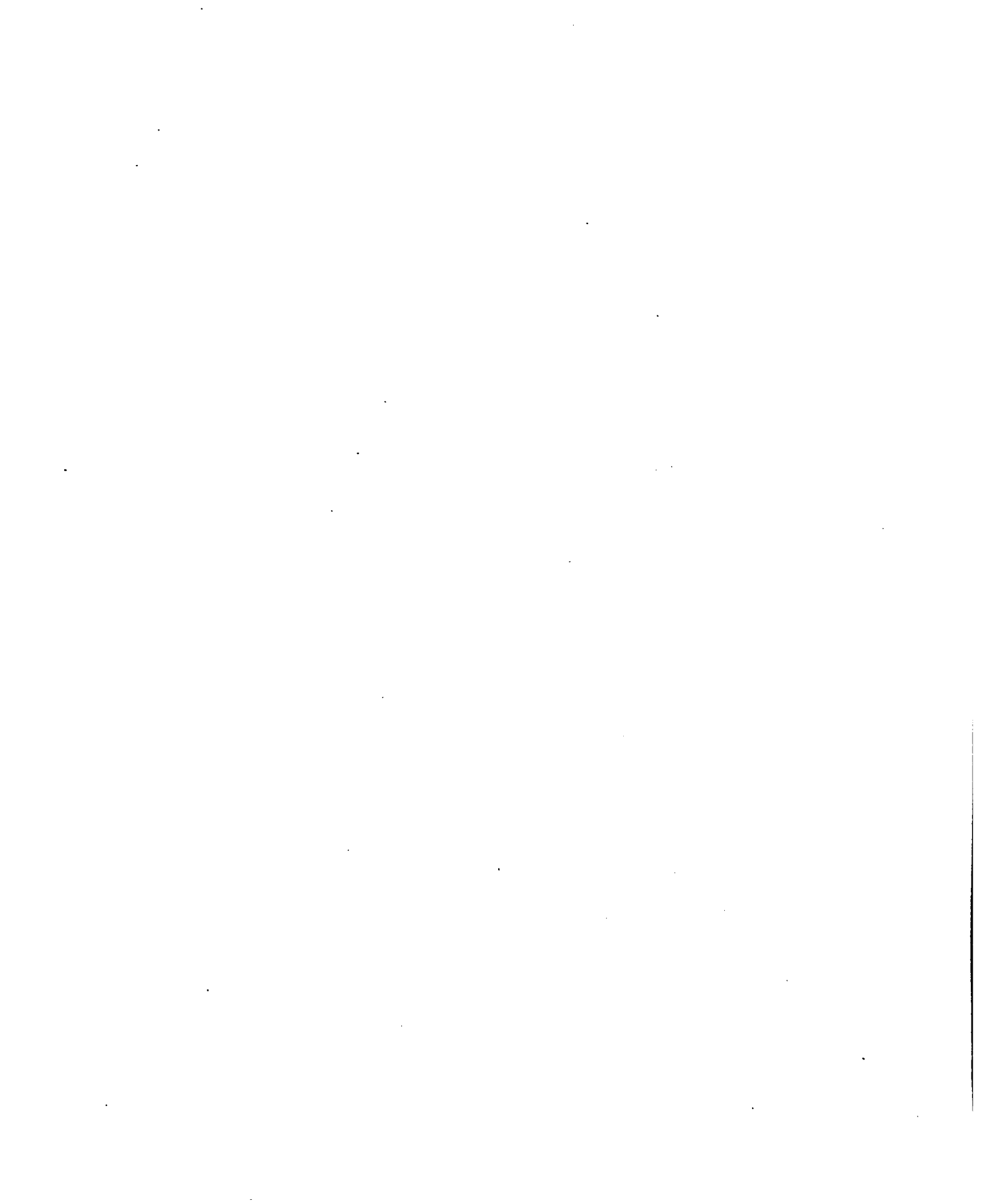


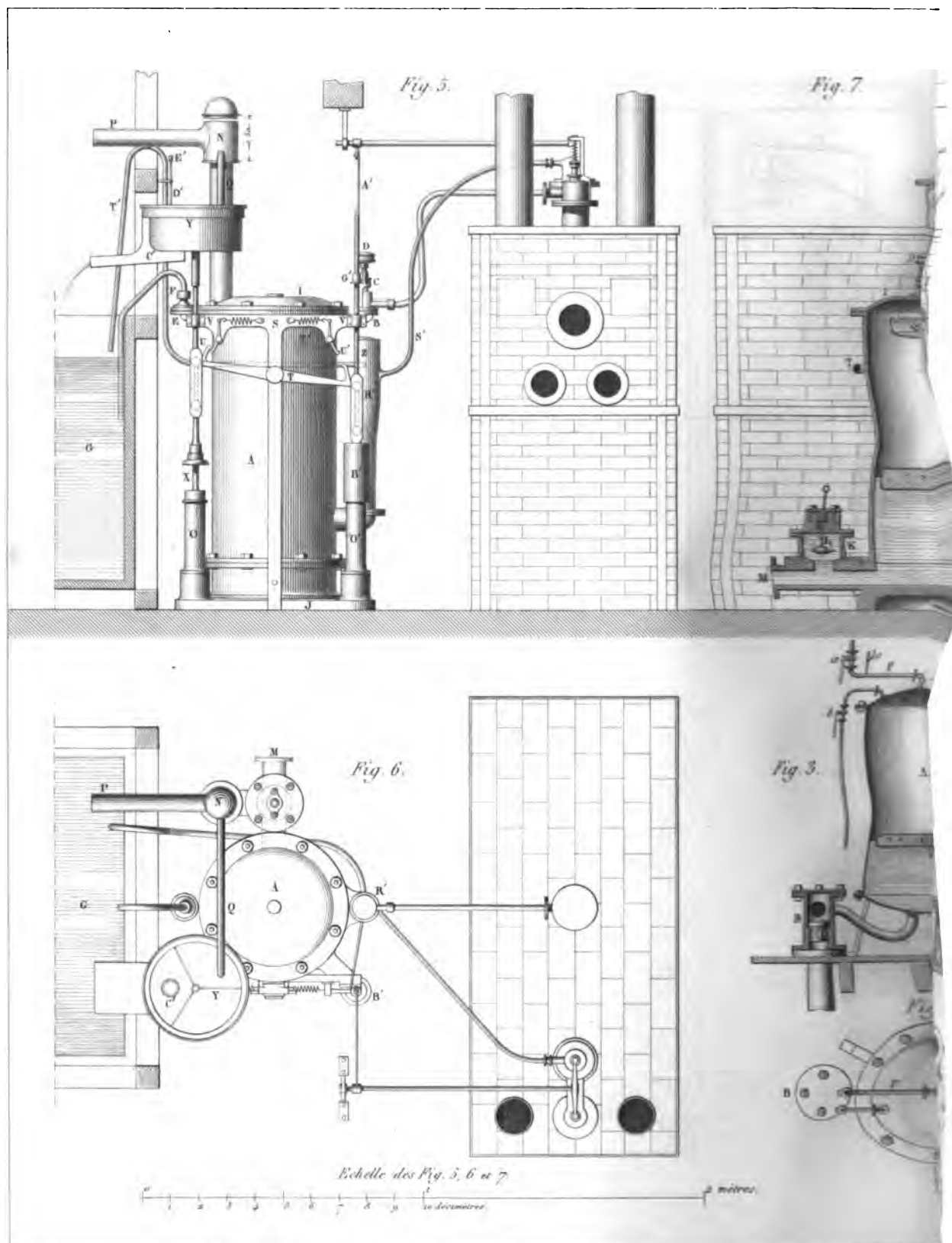












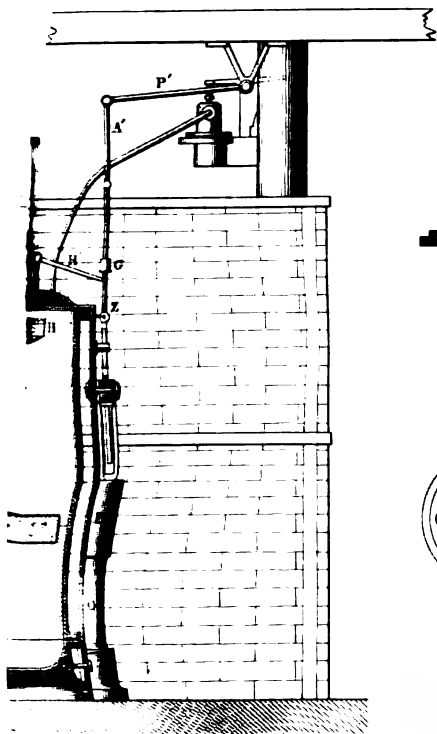


Fig. 8.

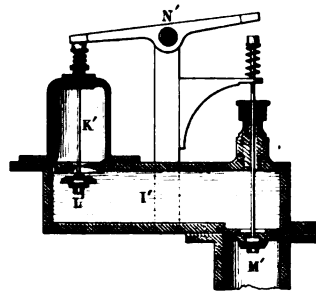


Fig. 9.

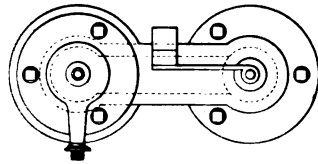


Fig. 10.

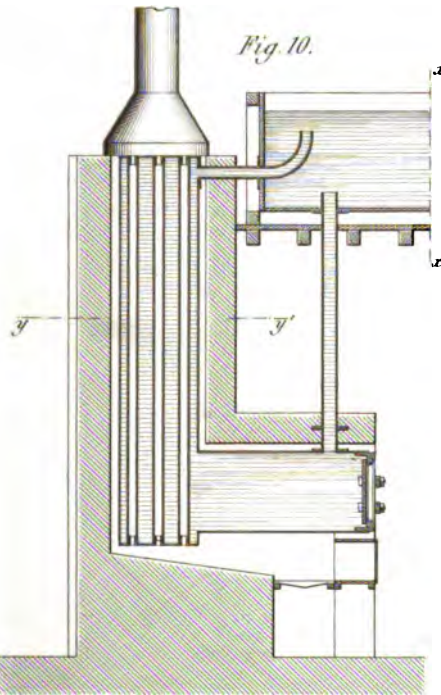


Fig. 11.

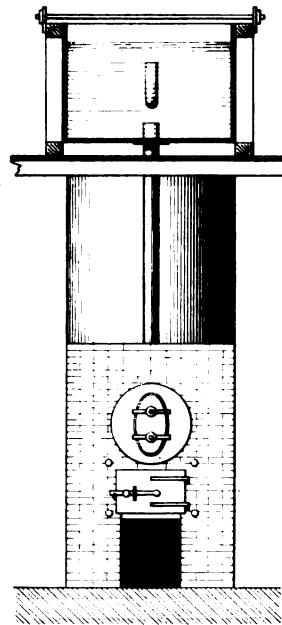
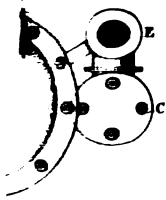
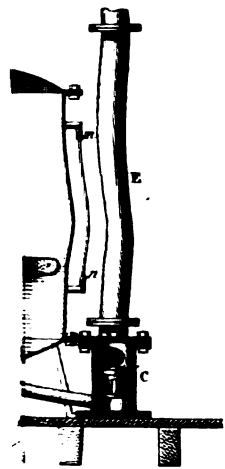


Fig. 12.



Echelle des Fig. 10, 11 et 12.

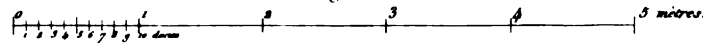
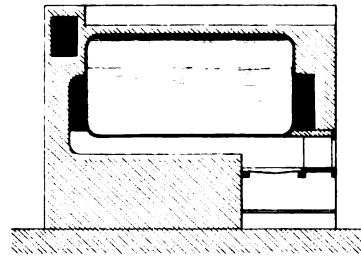


Fig. 1.



Echelle des Fig. 1 et 2.

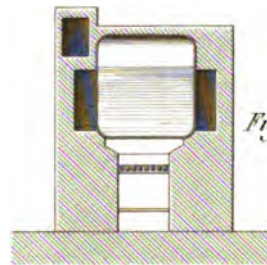
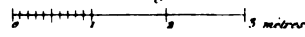
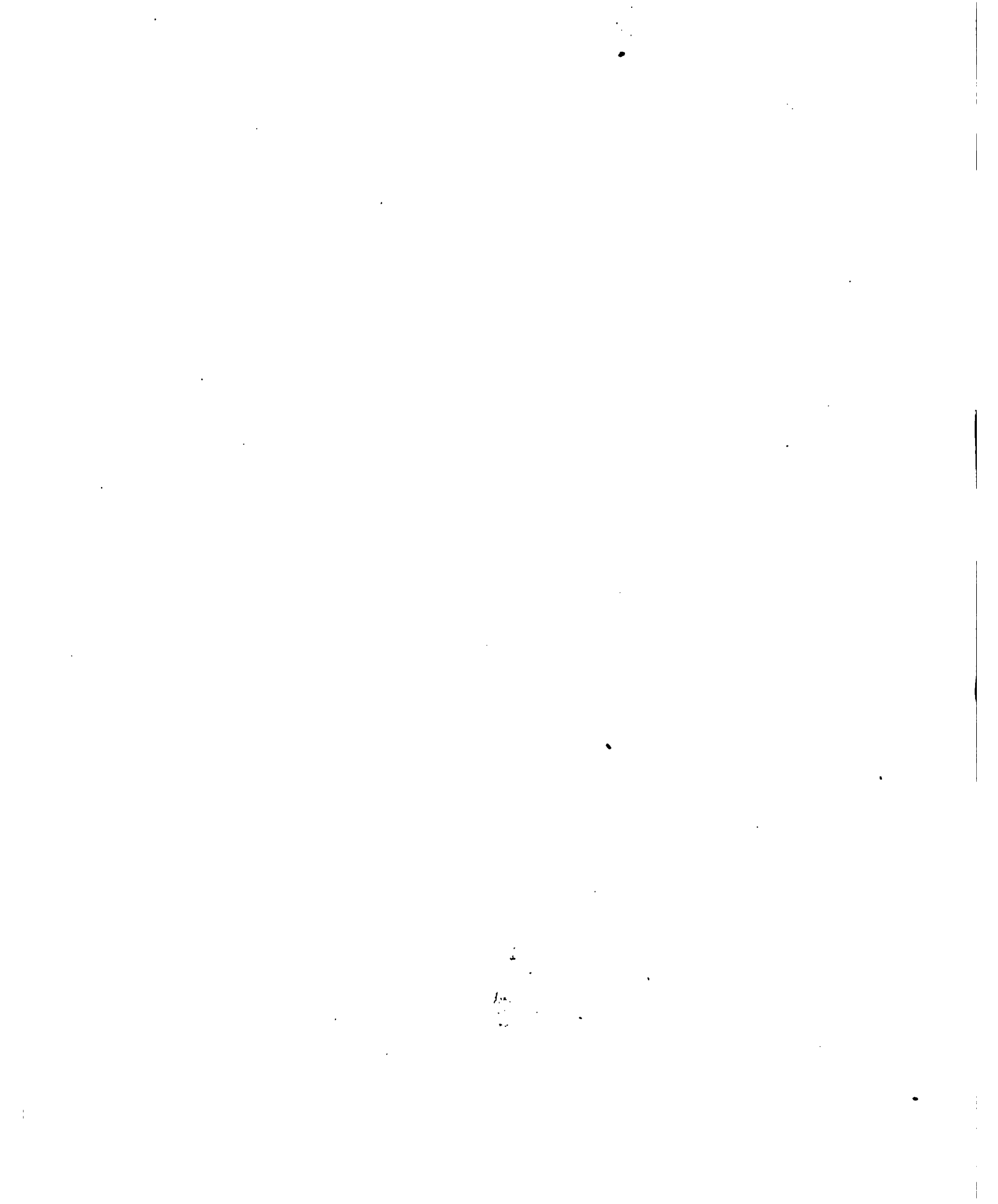
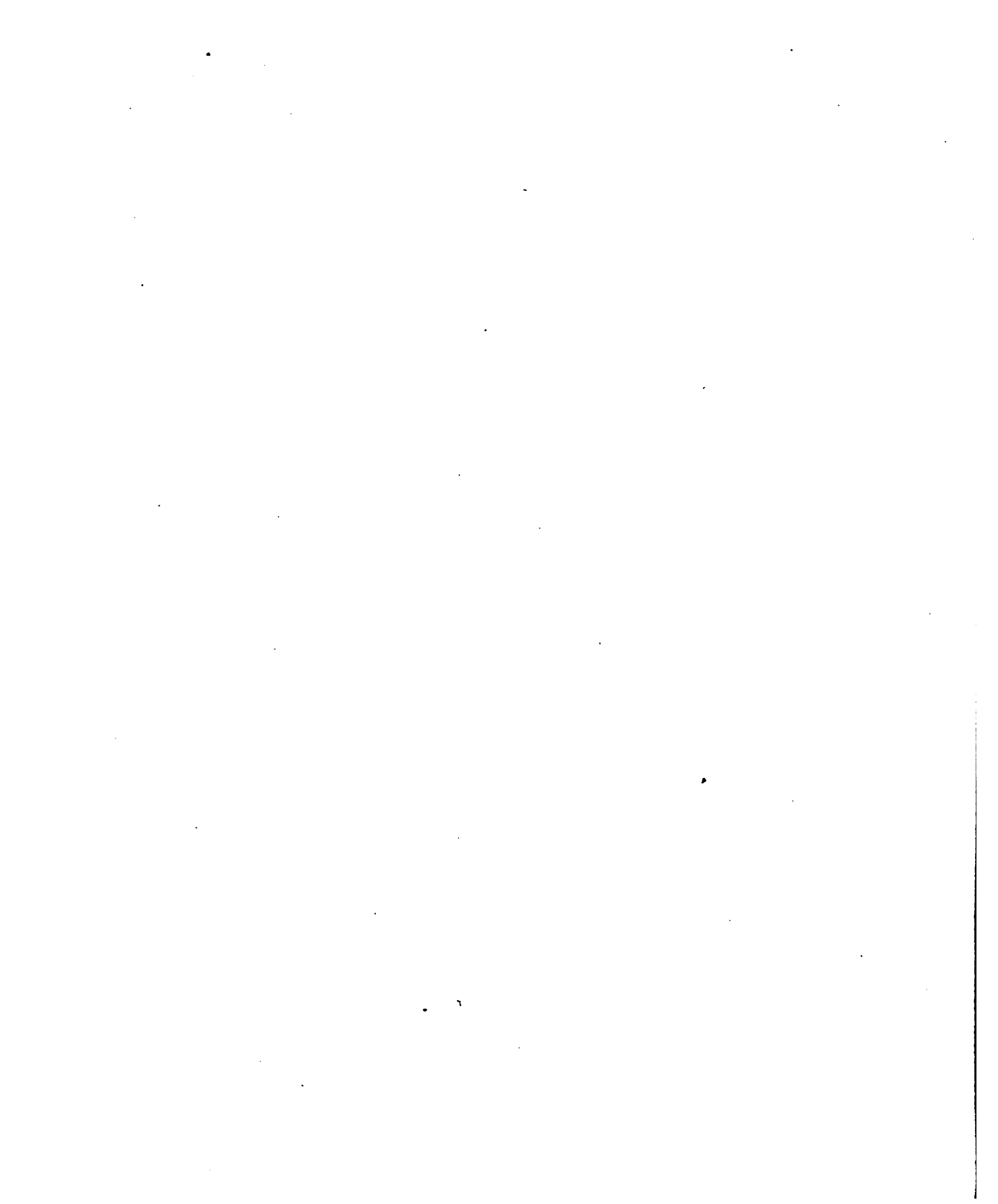
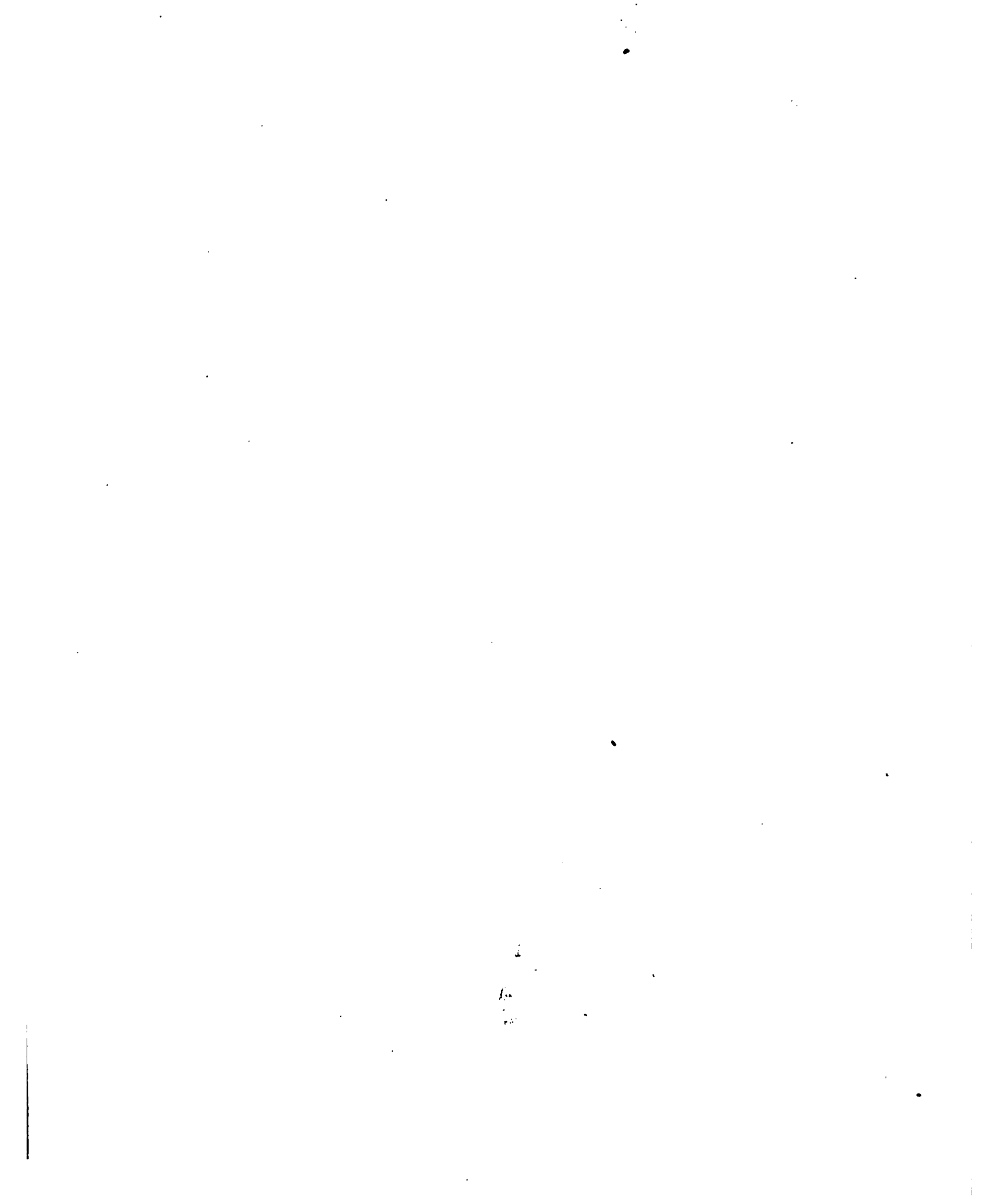
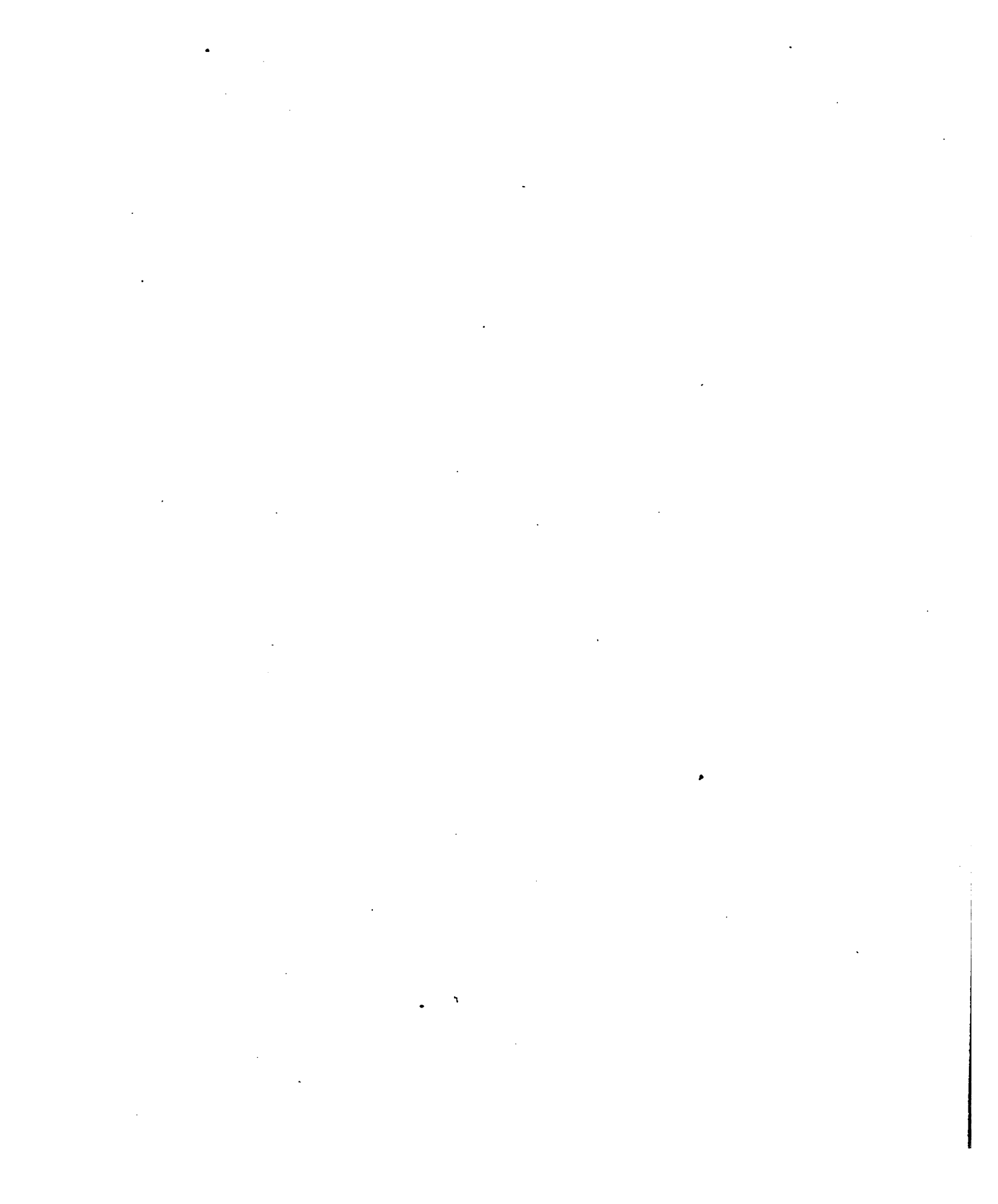


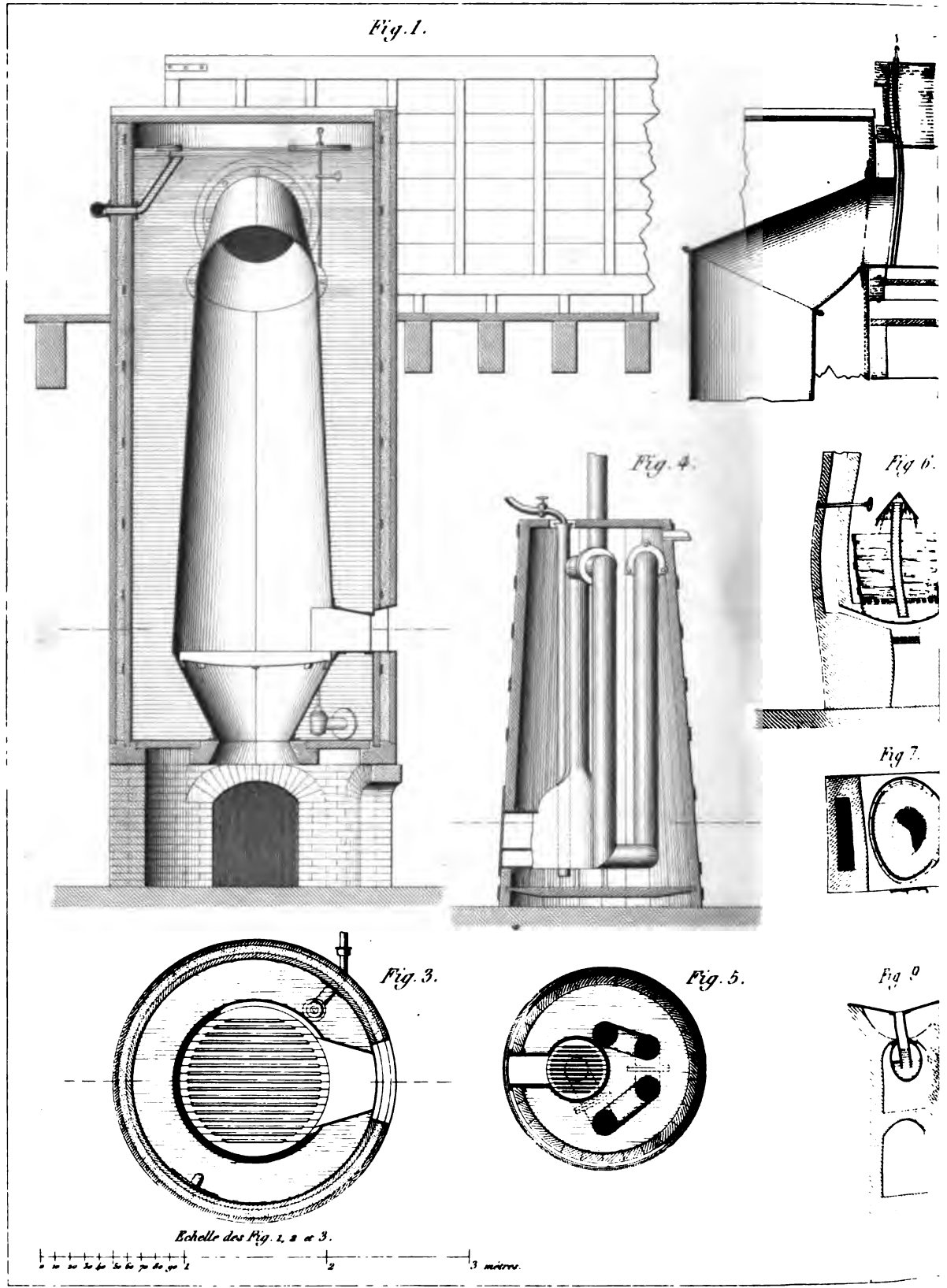
Fig. 2.

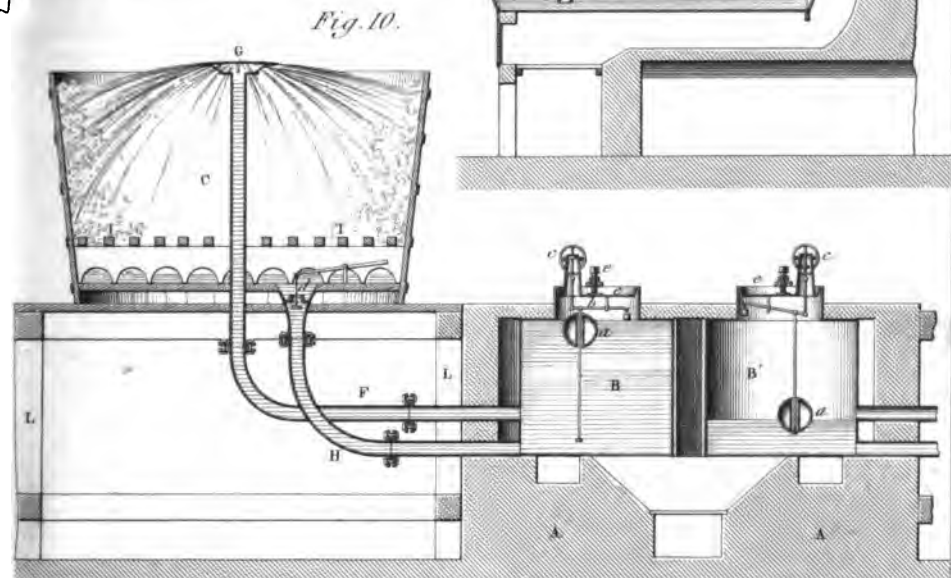
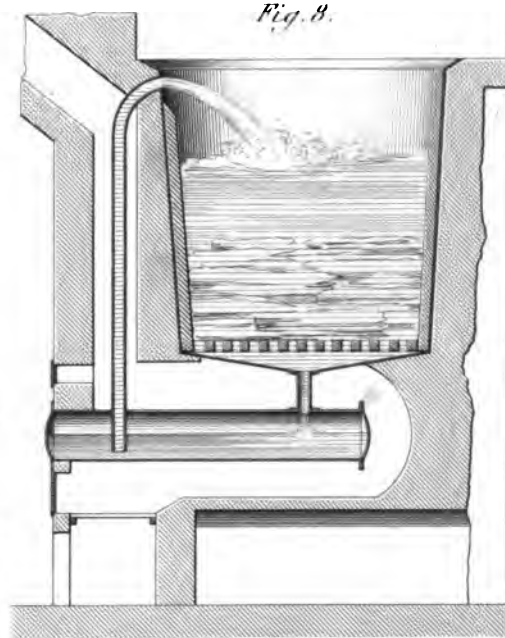
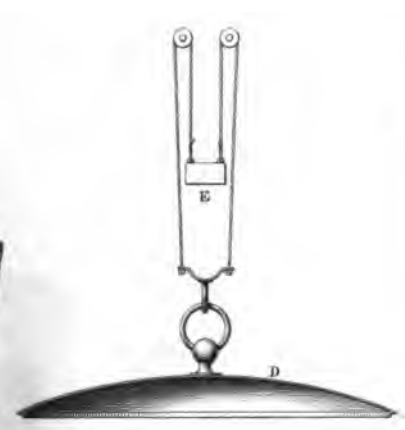
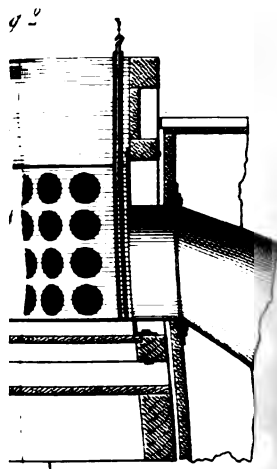




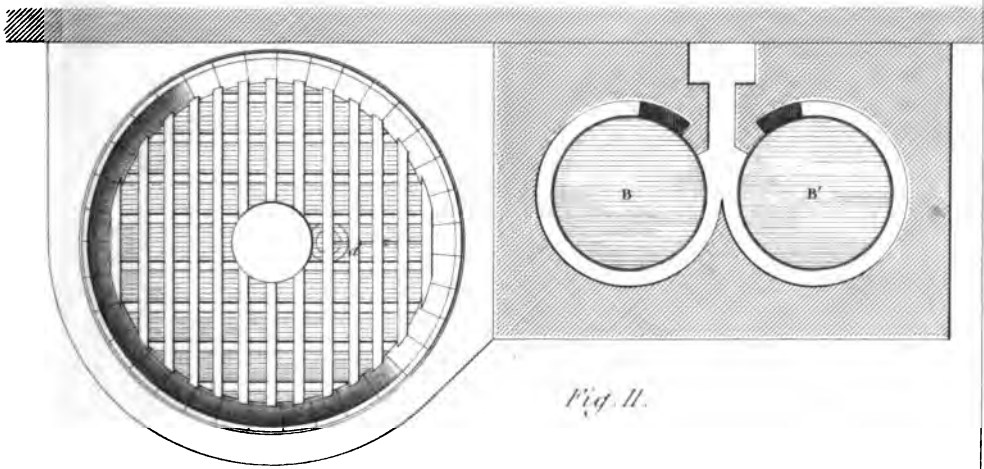








Echelle des Fig 10 et 11. 0 10 20 30 40 50 60 70 80 90 1 2 3 metres.







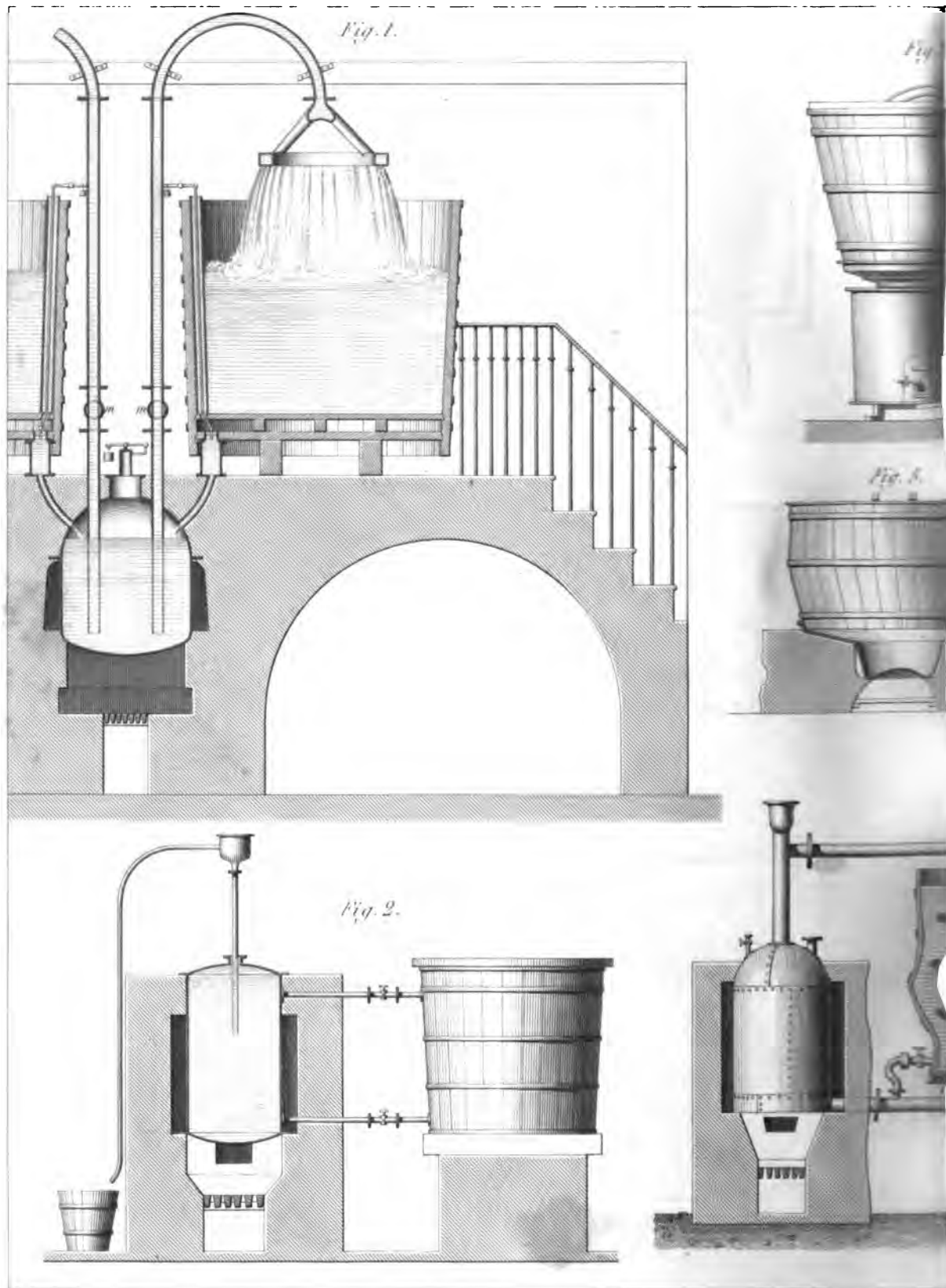


Fig. 4.

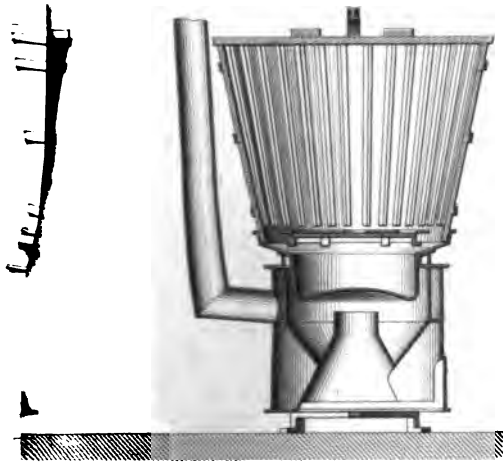


Fig. 7.

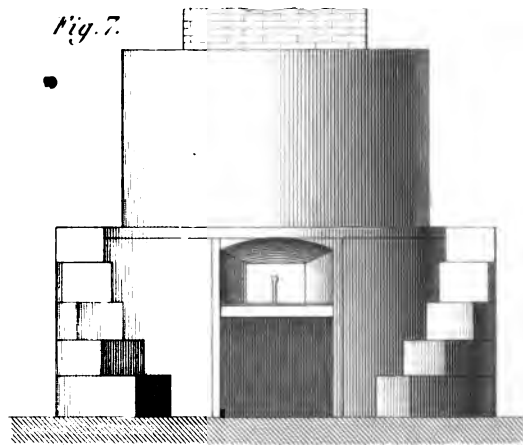


Fig. 8.

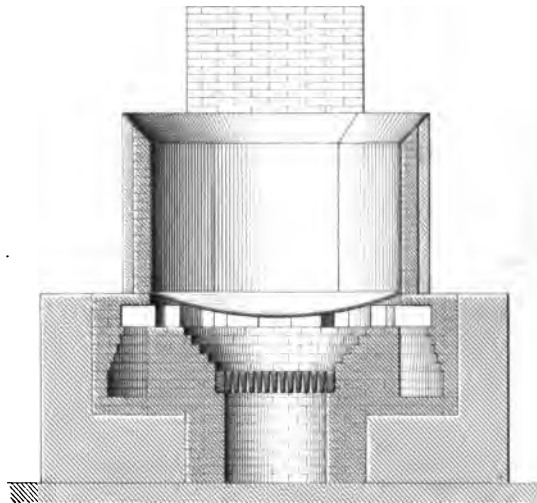


Fig. 6.

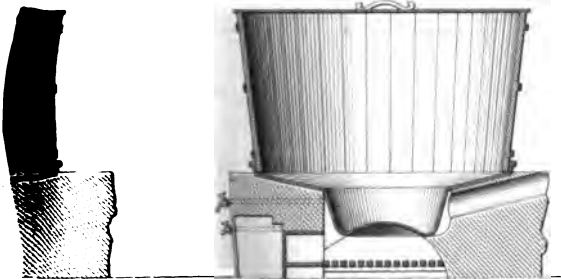


Fig. 10.

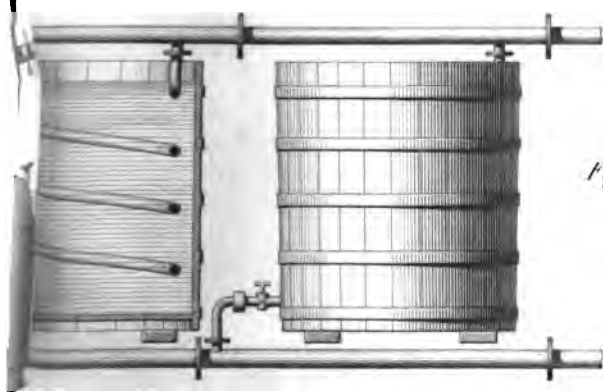
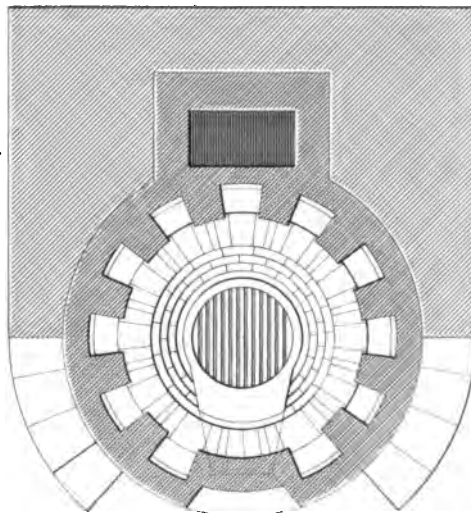
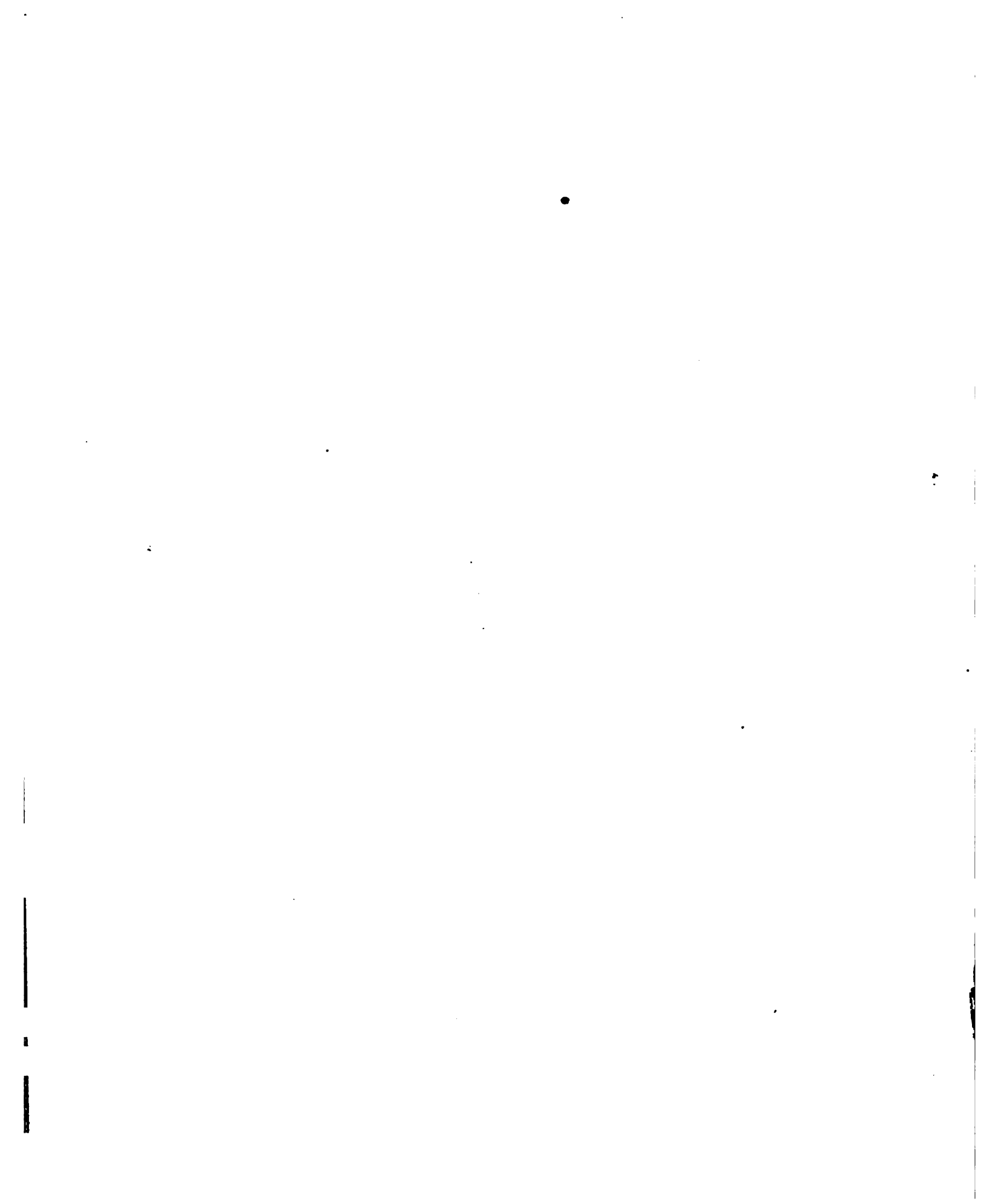
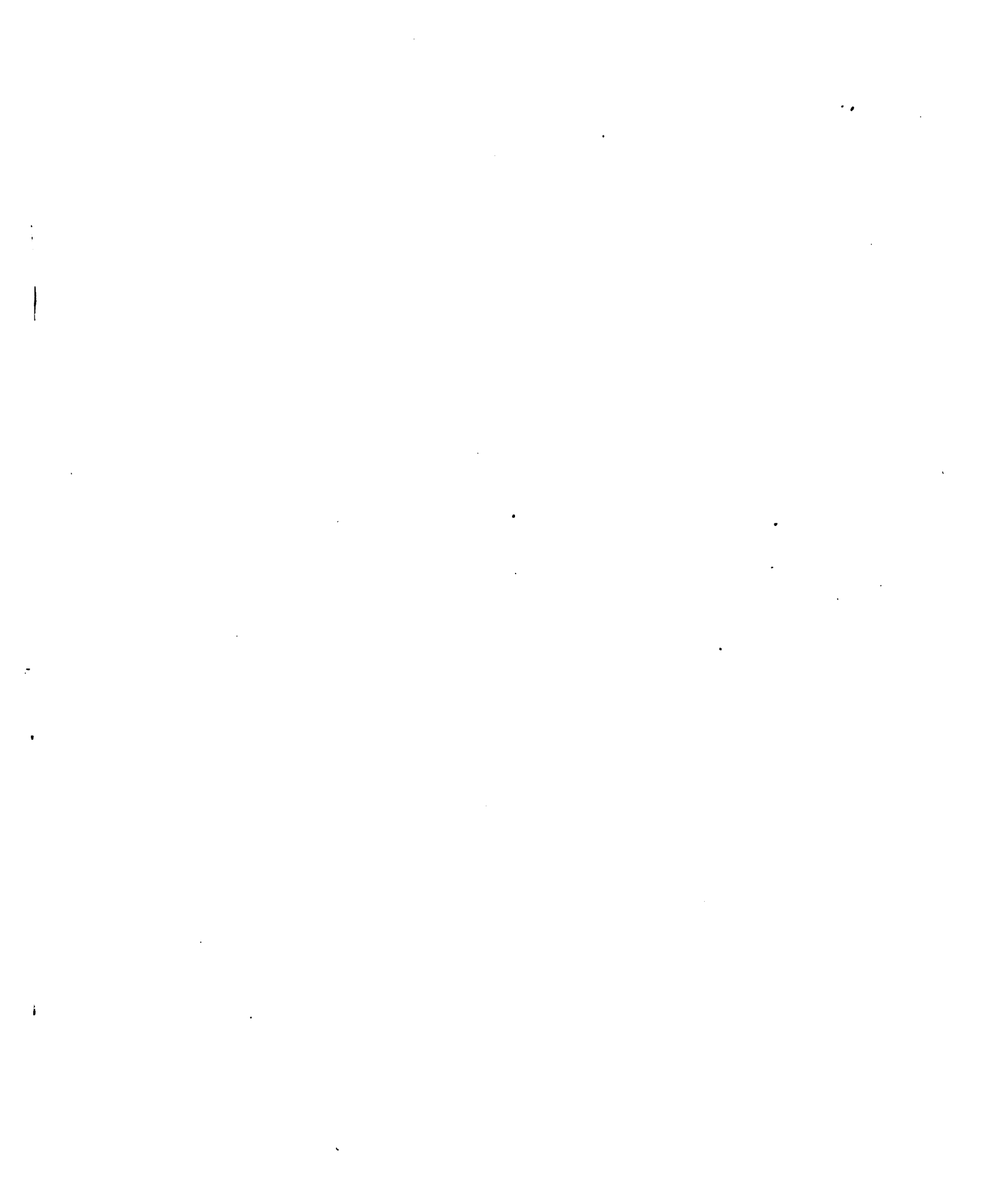


Fig. 9.







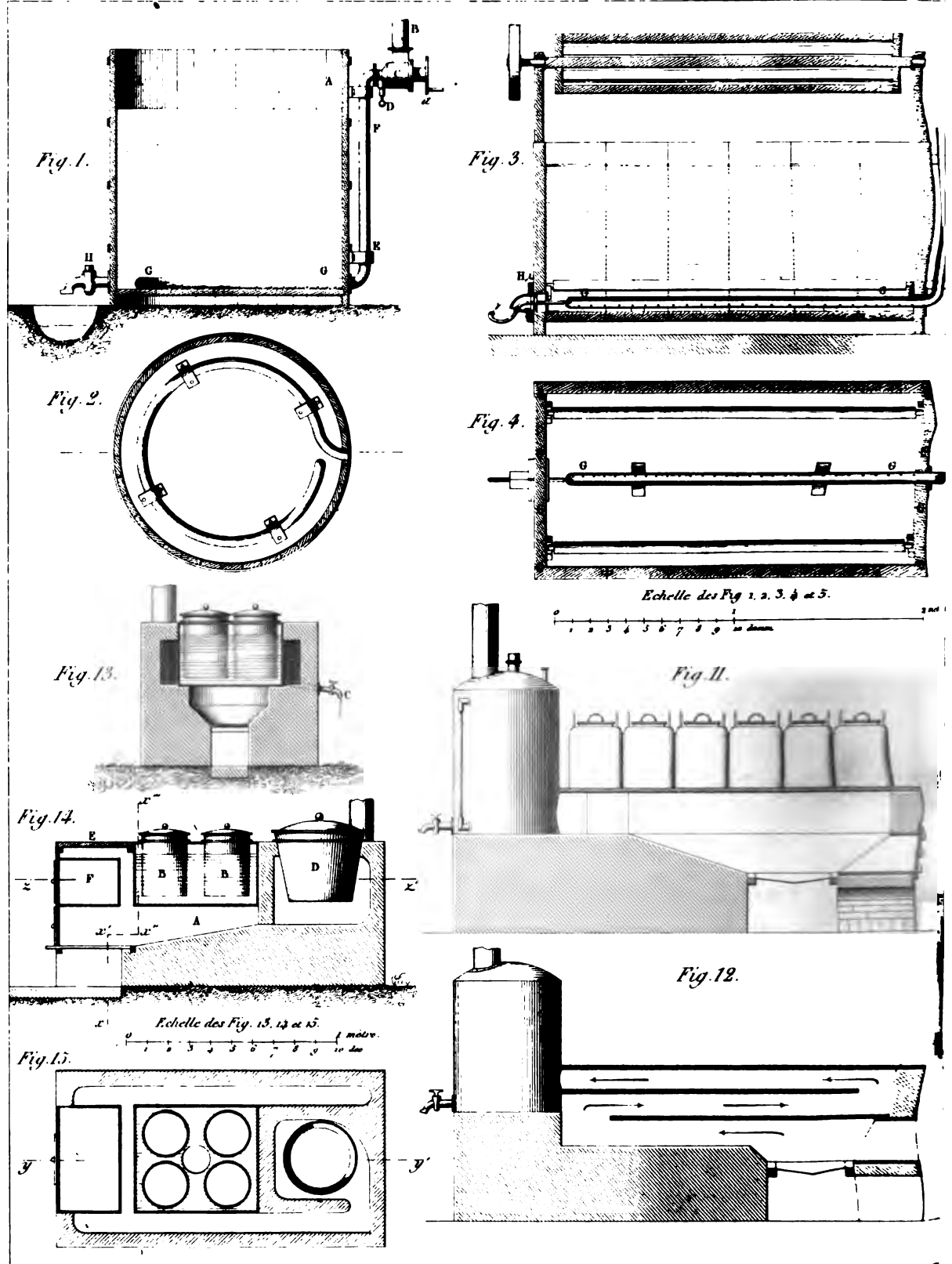


Fig. 5.

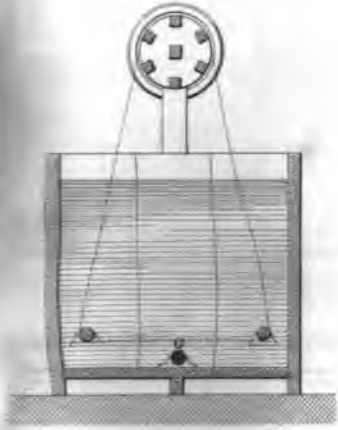
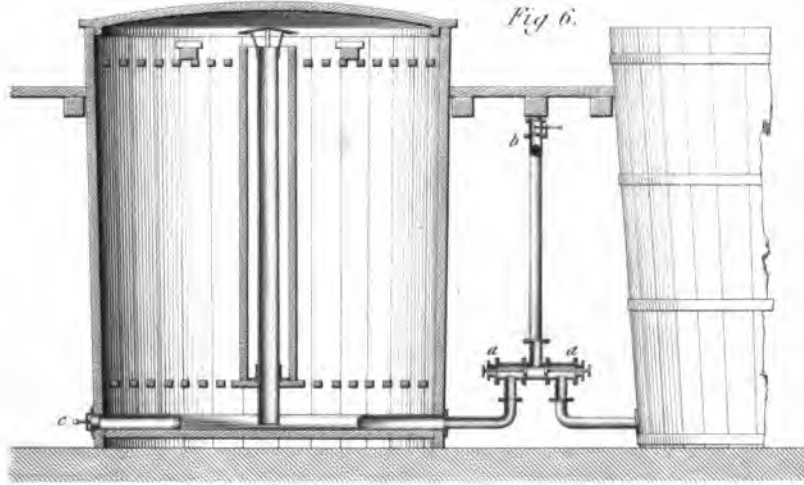


Fig. 6.



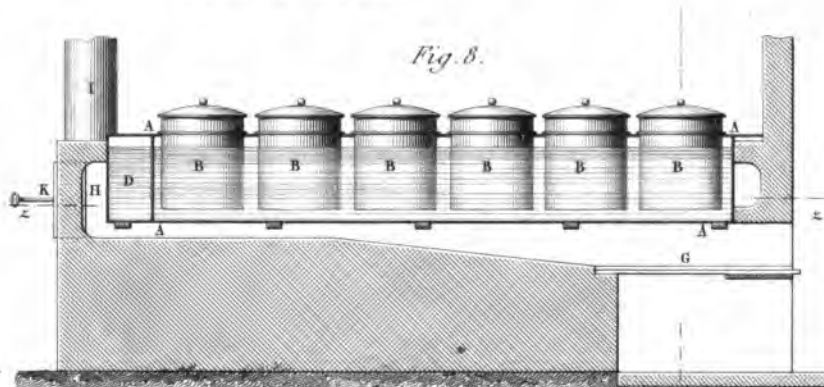
Echelle de la Fig. 6.



Fig. 7.



Fig. 8.



Echelle des Fig. 7, 8 et 9.

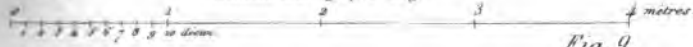
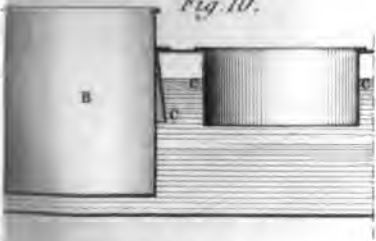


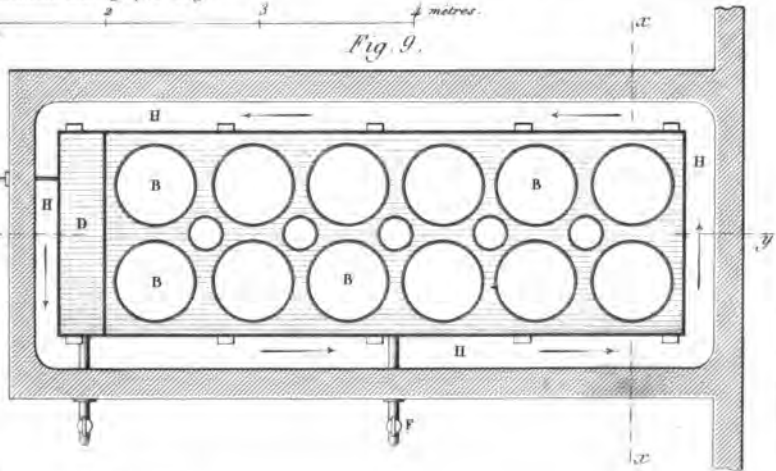
Fig. 10.



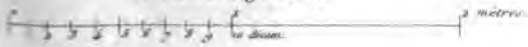
Echelle de la Fig. 10.

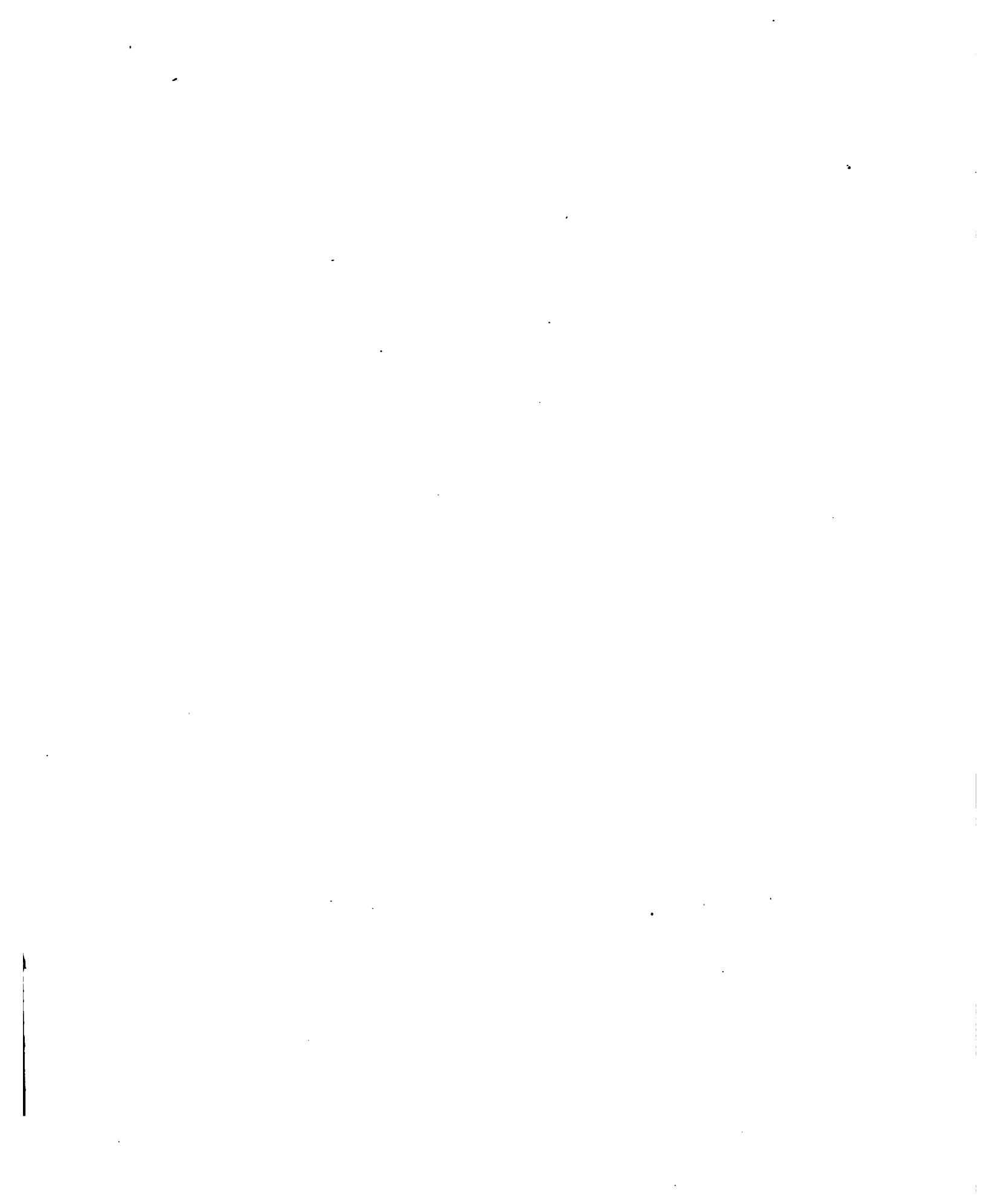


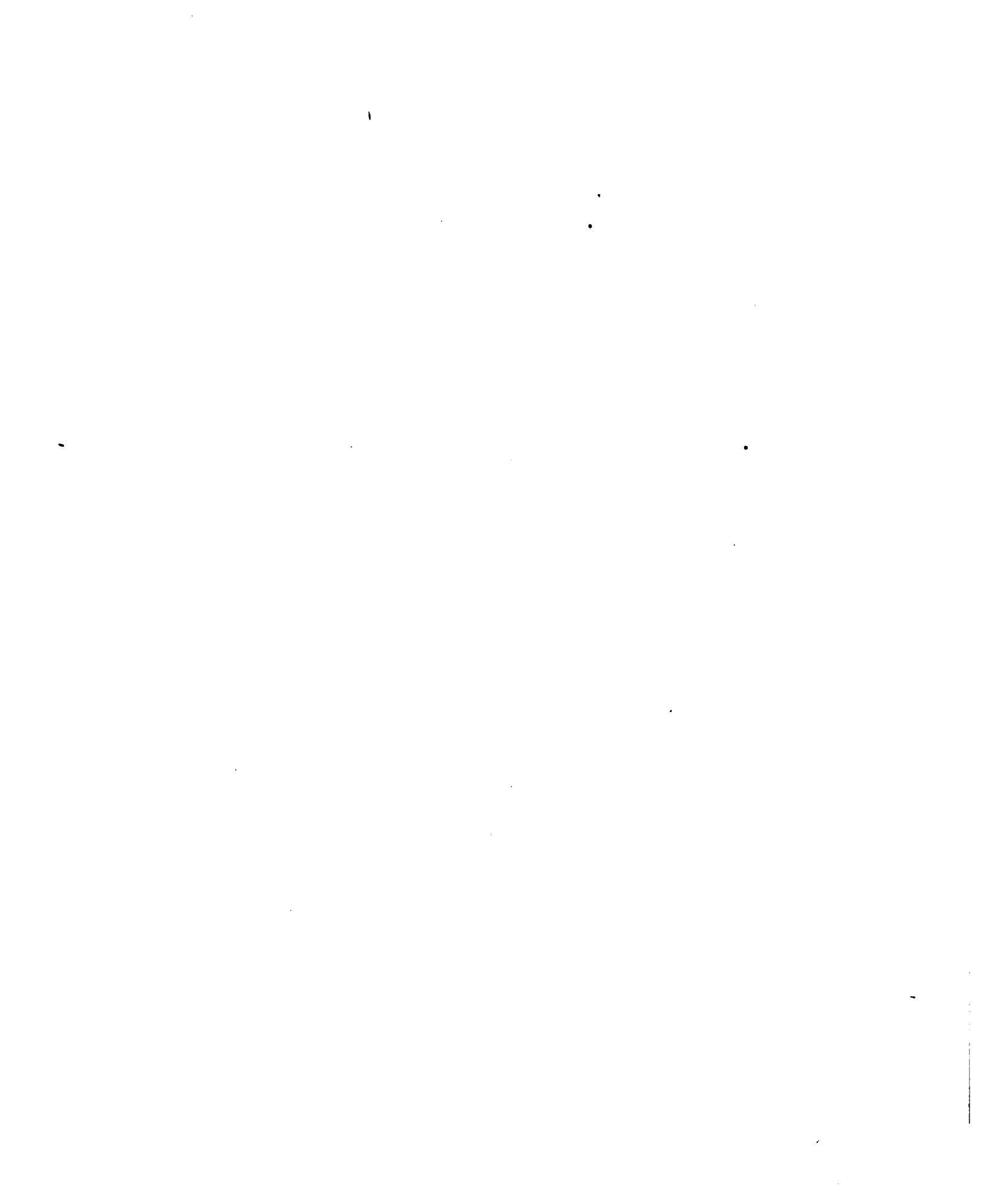
Fig. 9.

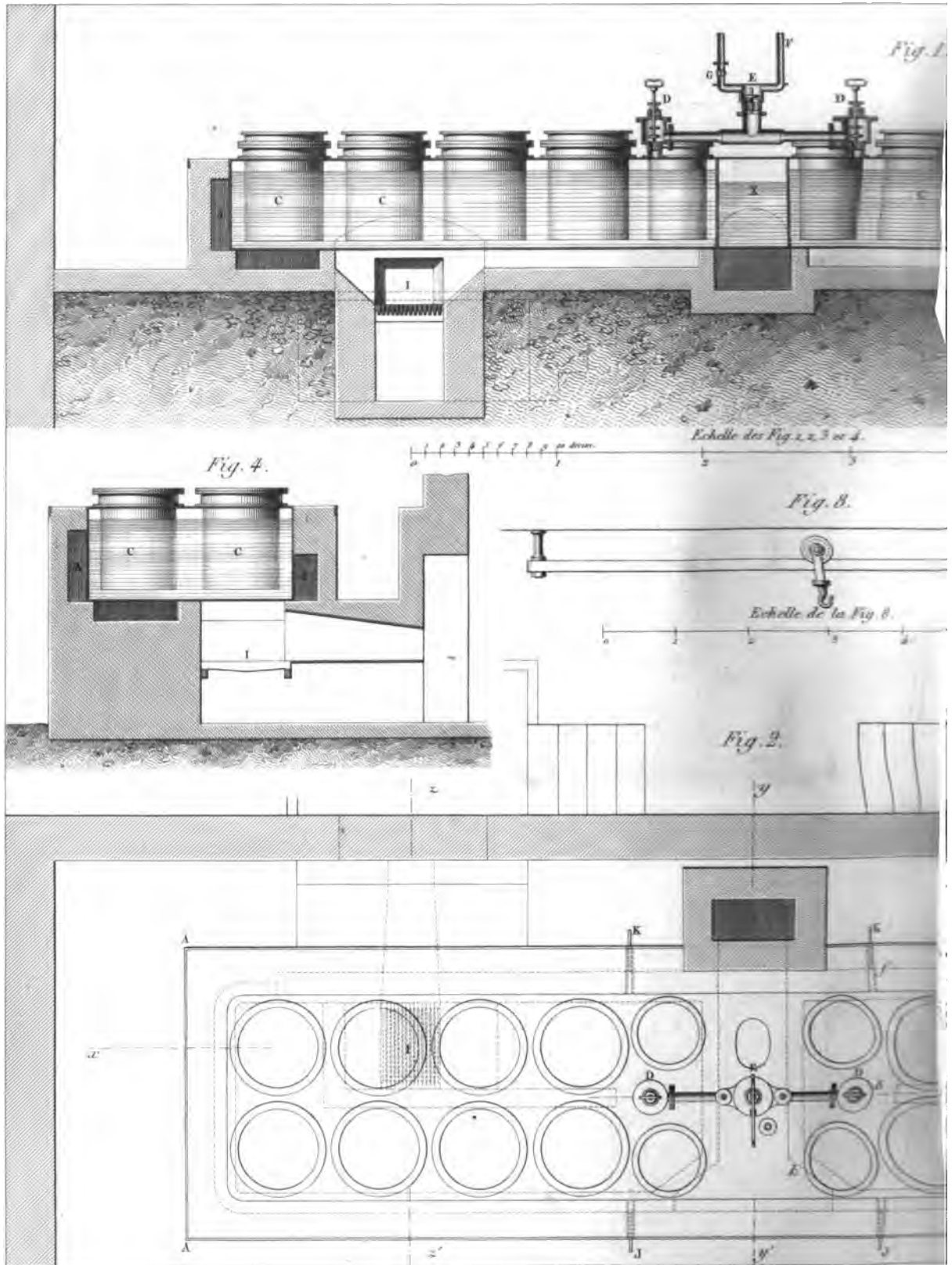


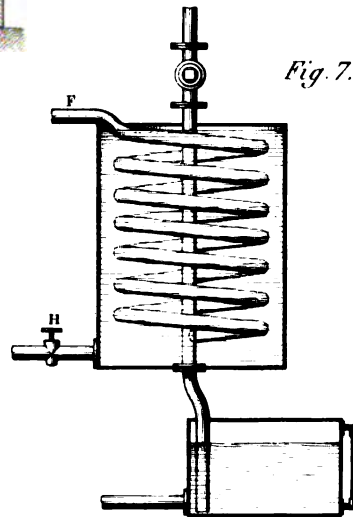
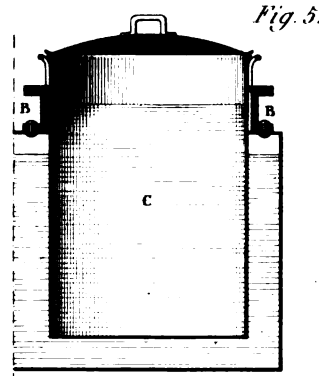
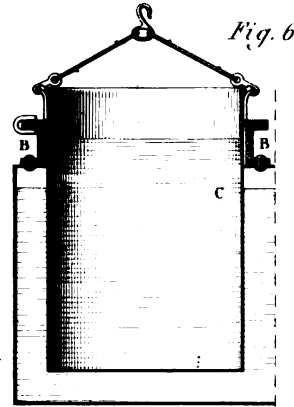
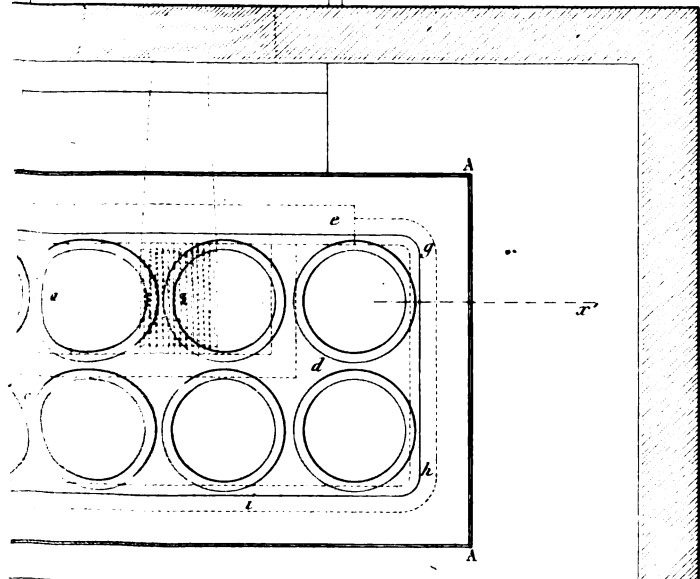
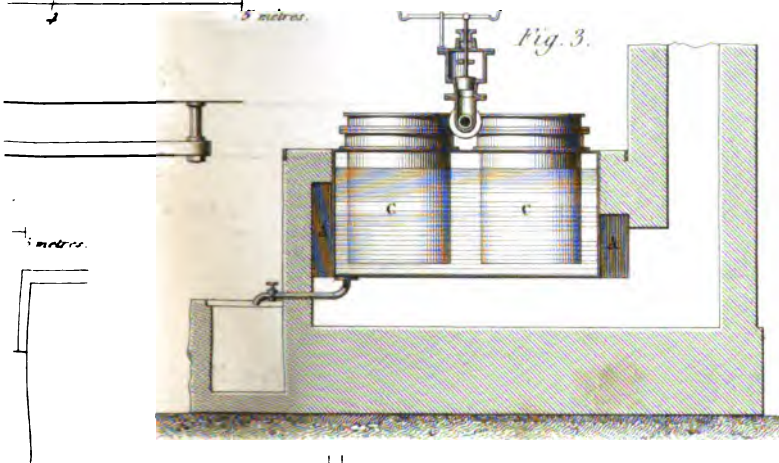
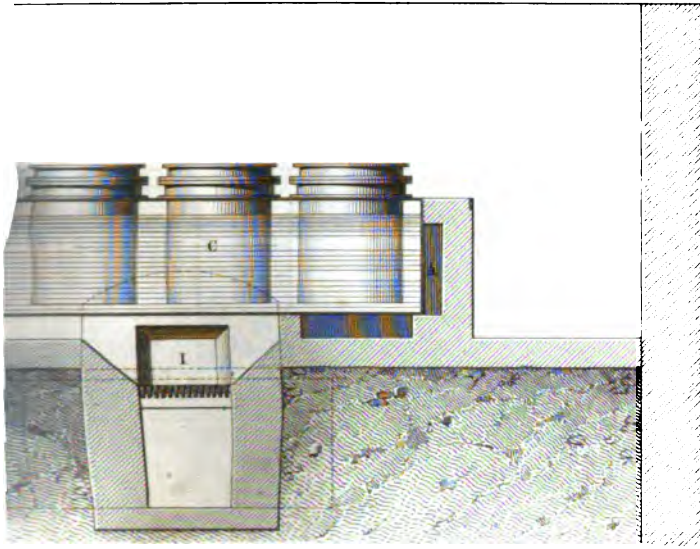
Echelle des Fig. 11 et 12.



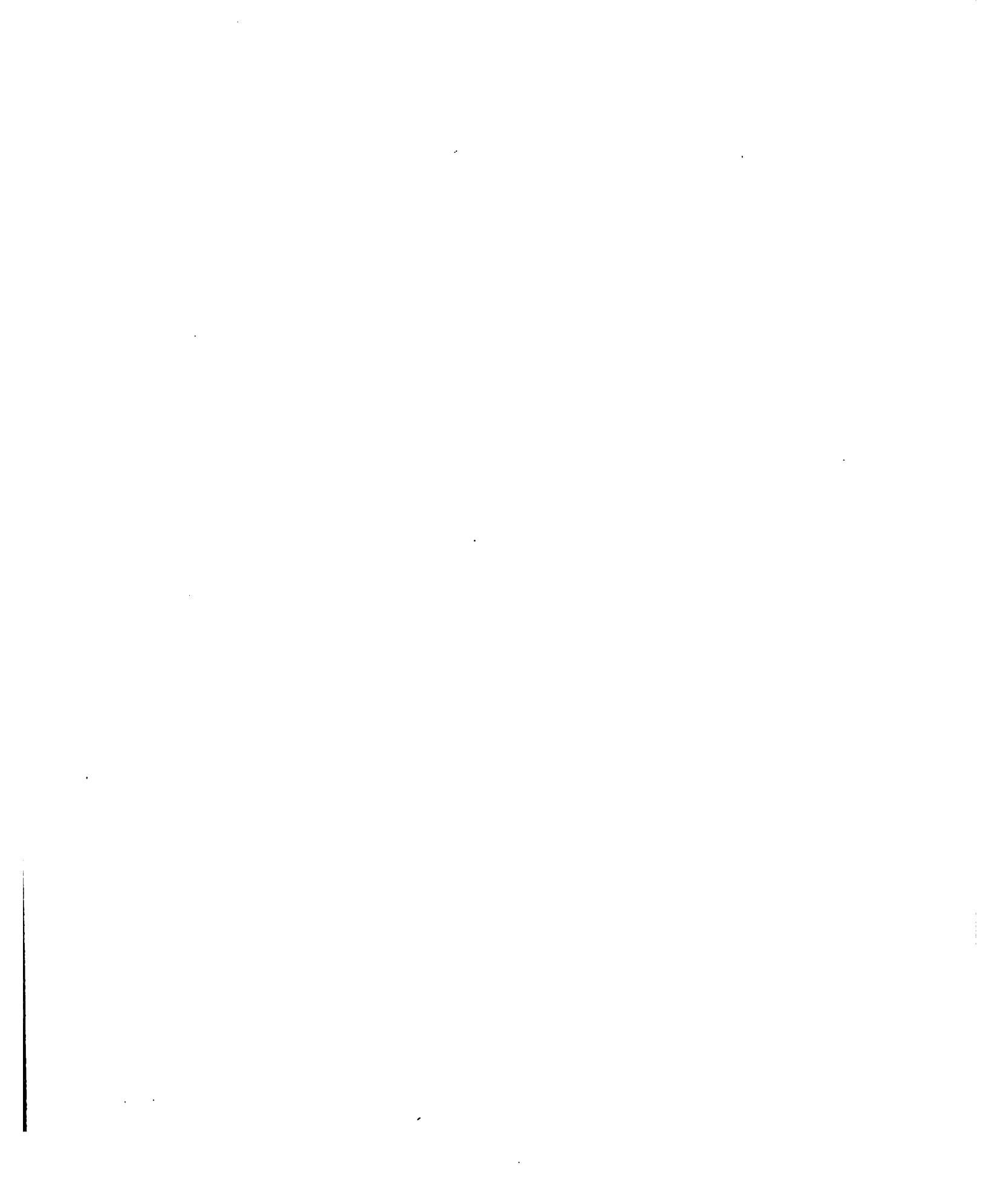








Echelle des Fig. 5, 6 et 7.
0 1 2 3 4 5 6 7 8 9 10 mètres
ou decim.





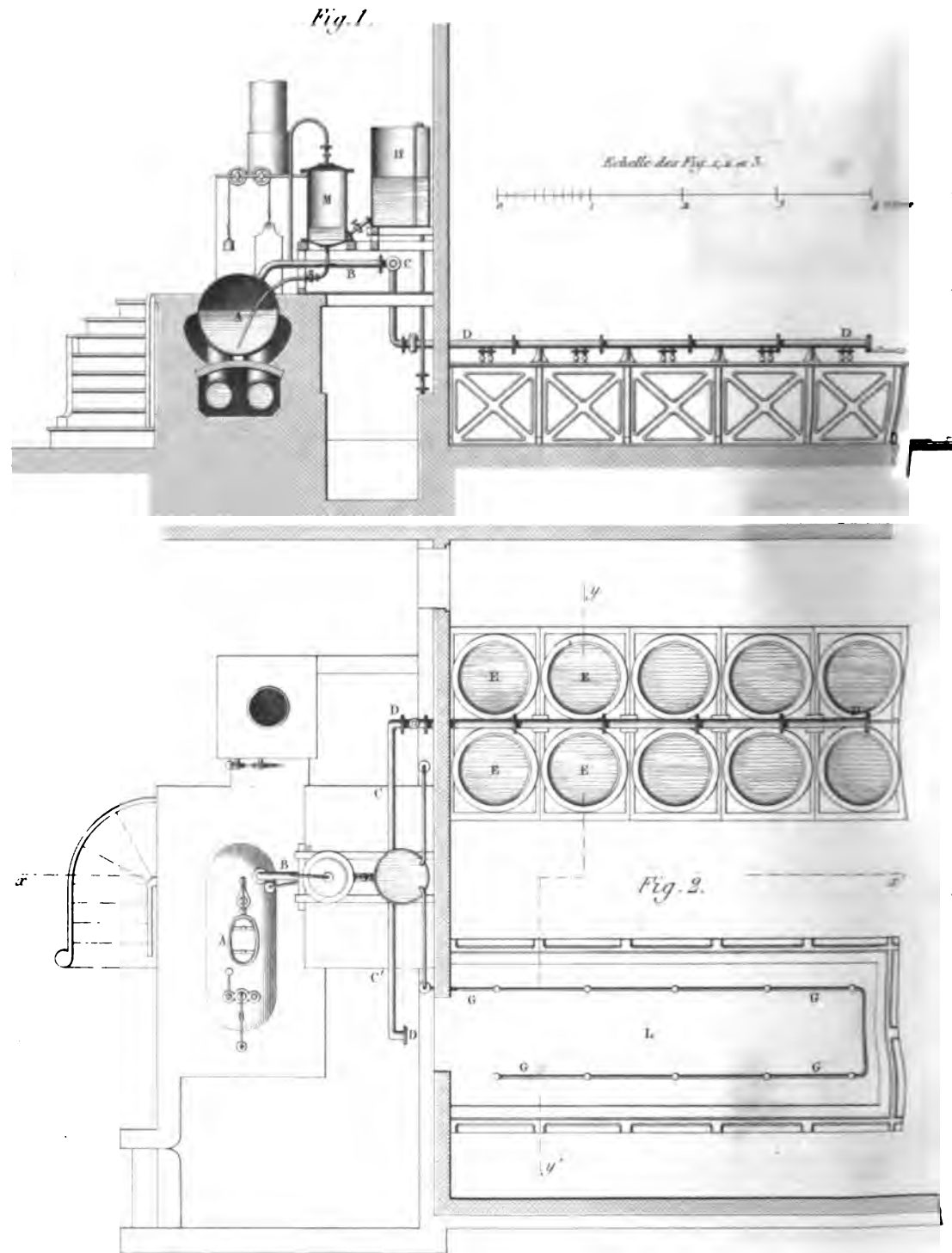


Fig. 3.

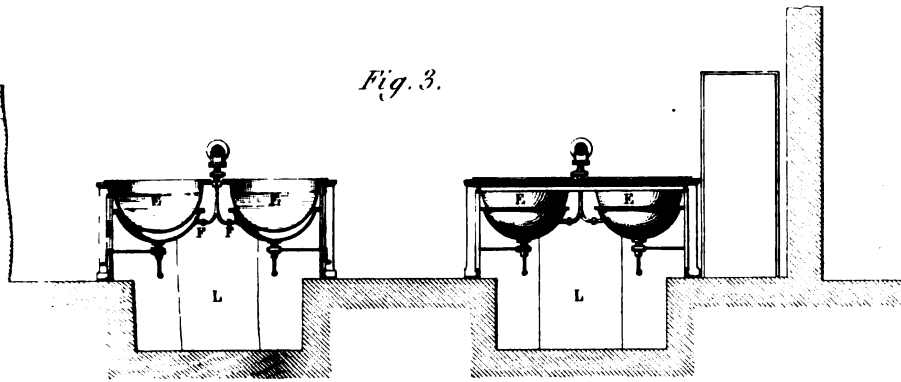


Fig. 4.

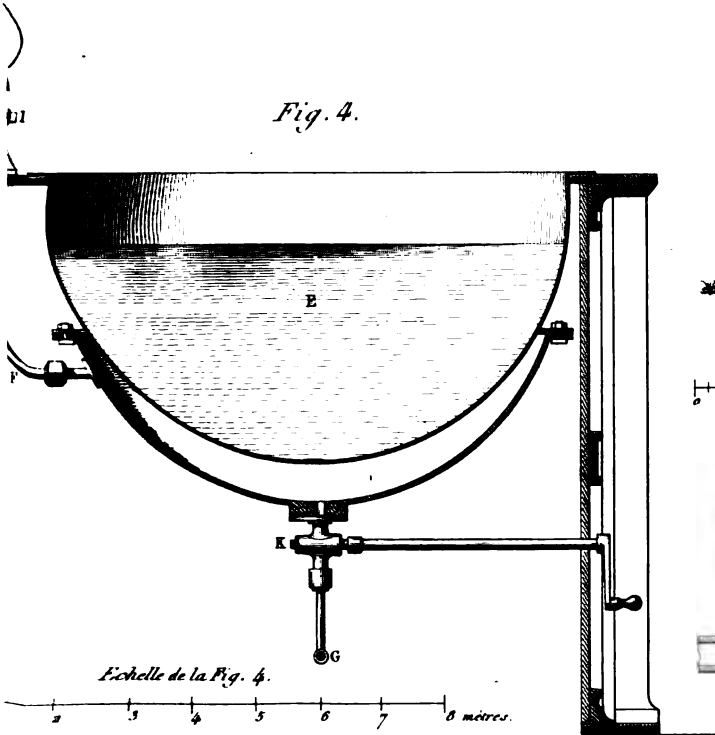
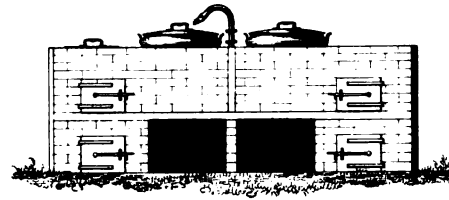


Fig. 5.



Echelle des Fig. 5, 6, 7 et 8.



Fig. 6.



Fig. 9.

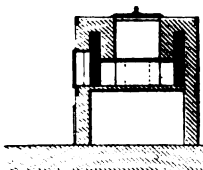


Fig. 8.

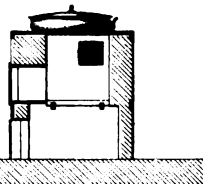
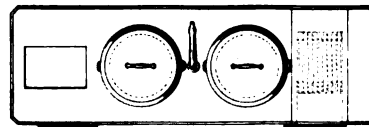
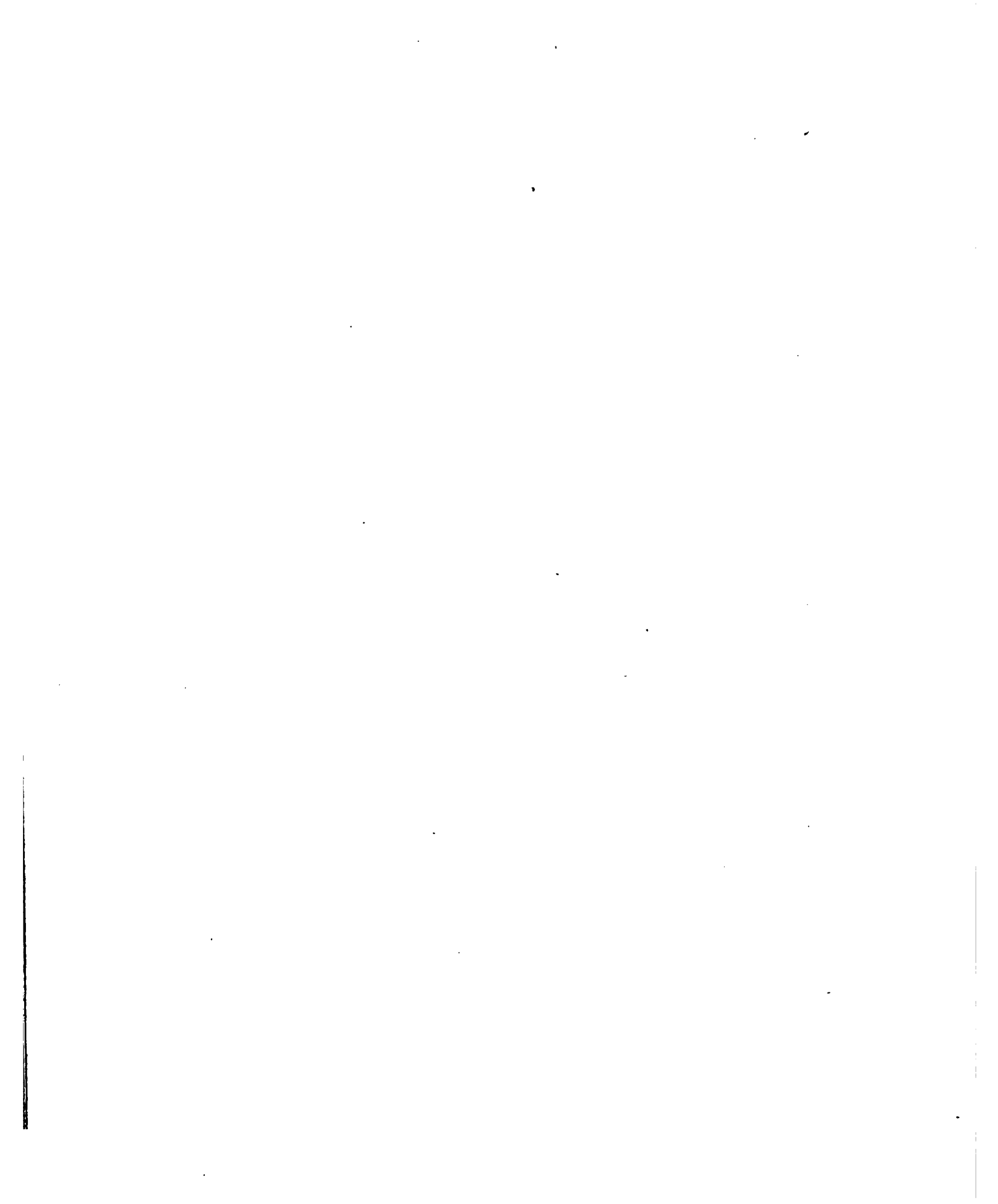


Fig. 7.





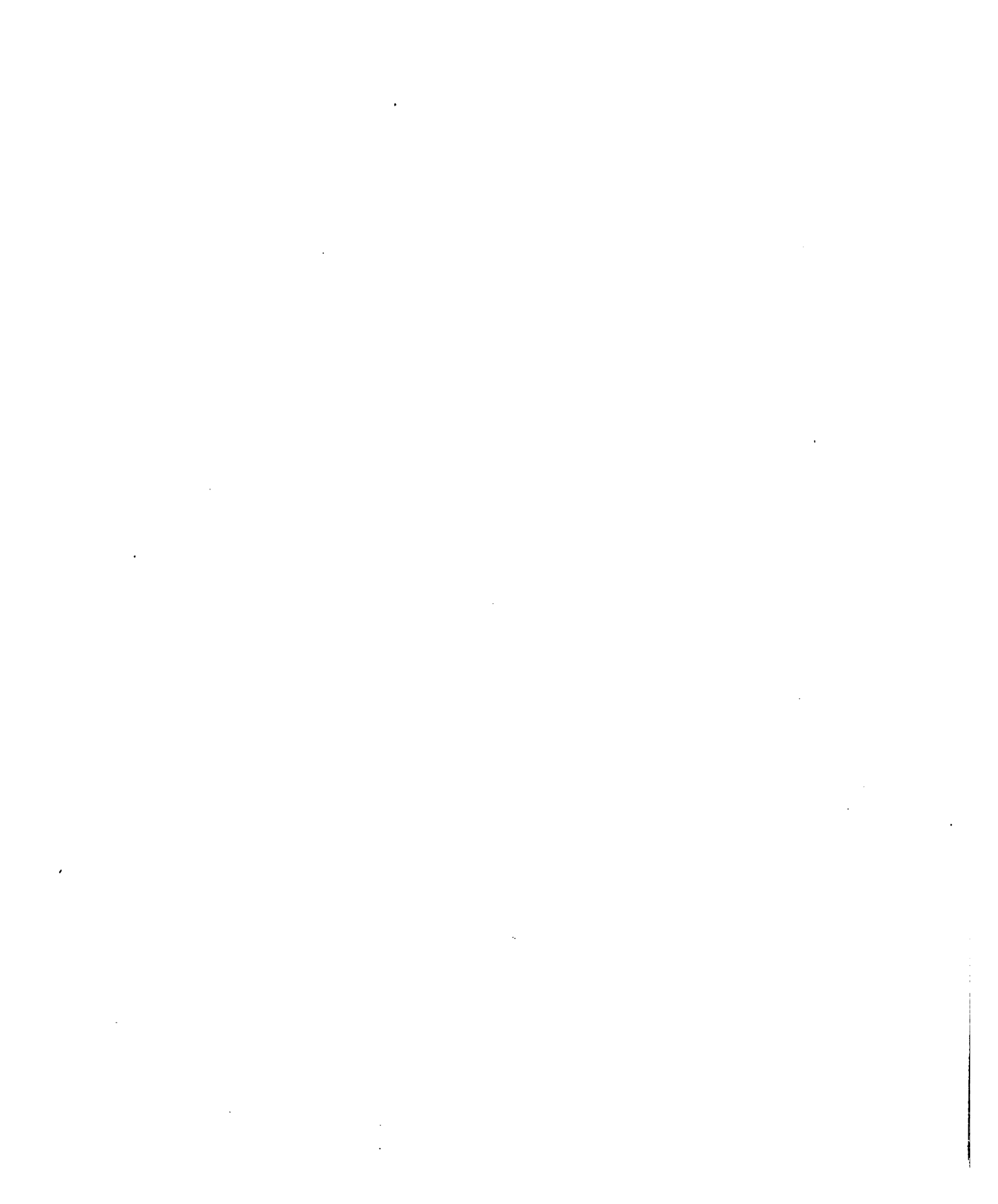


Fig. 1.

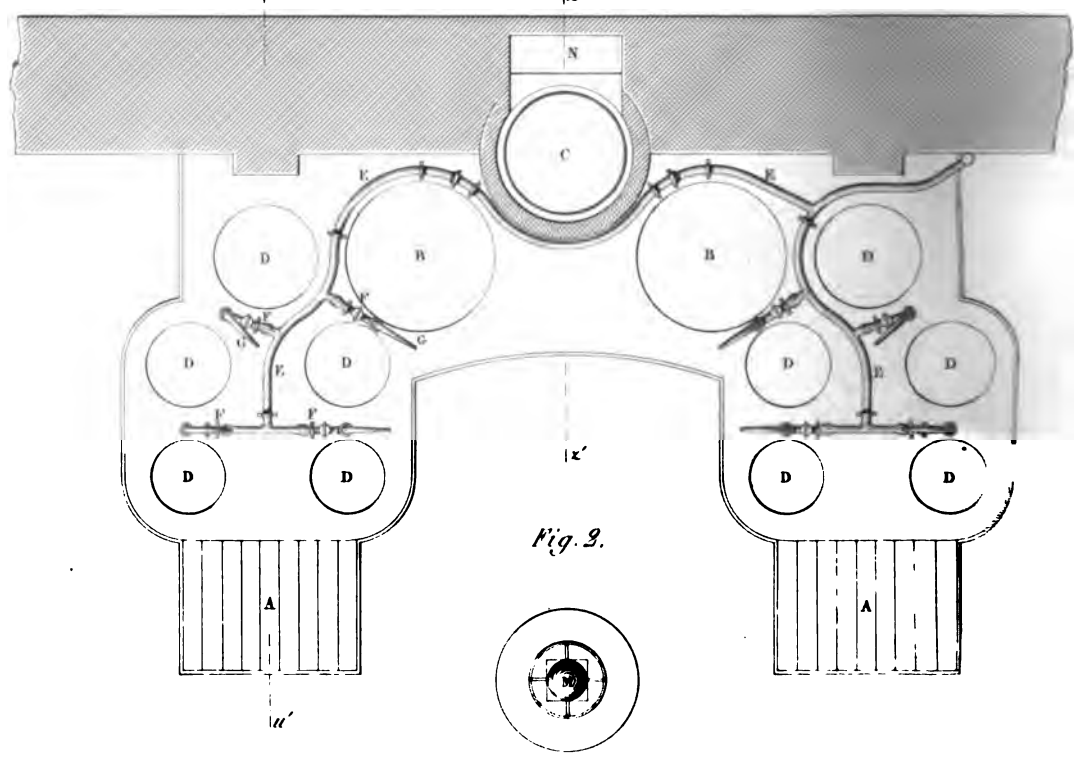
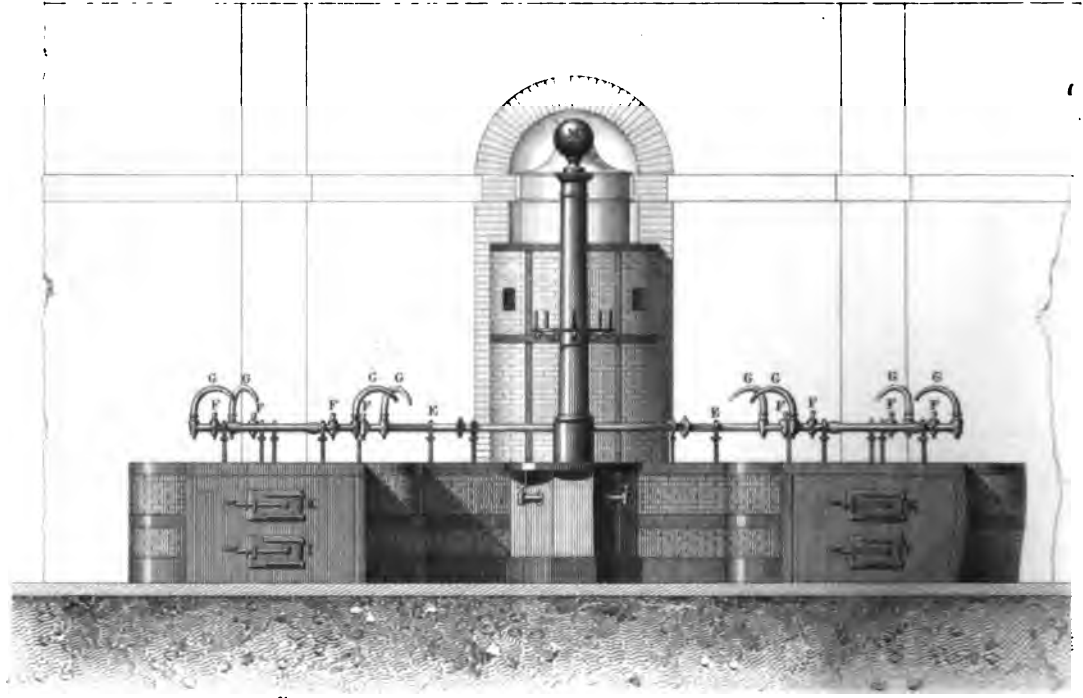
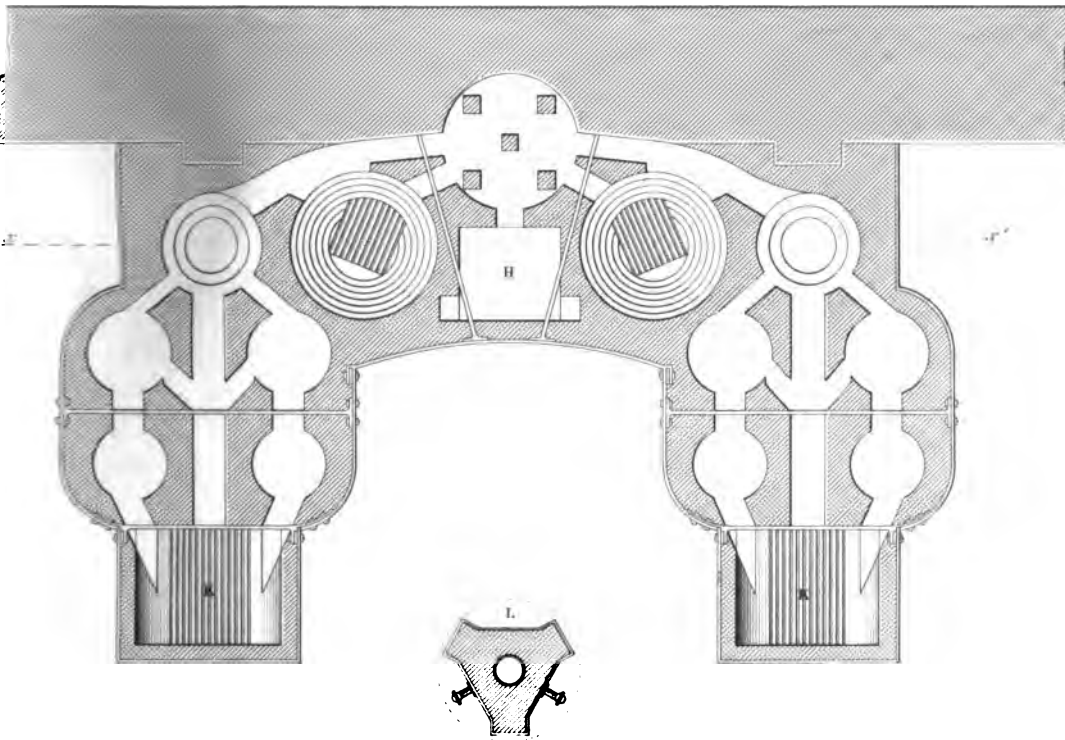
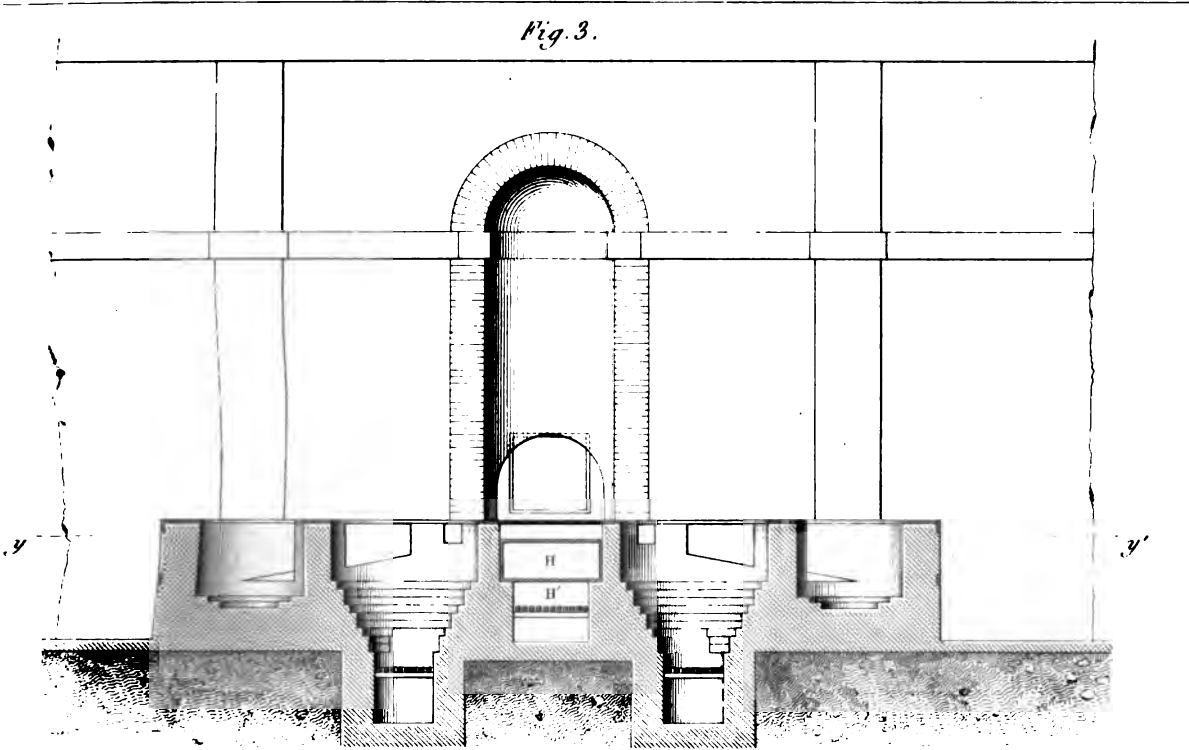


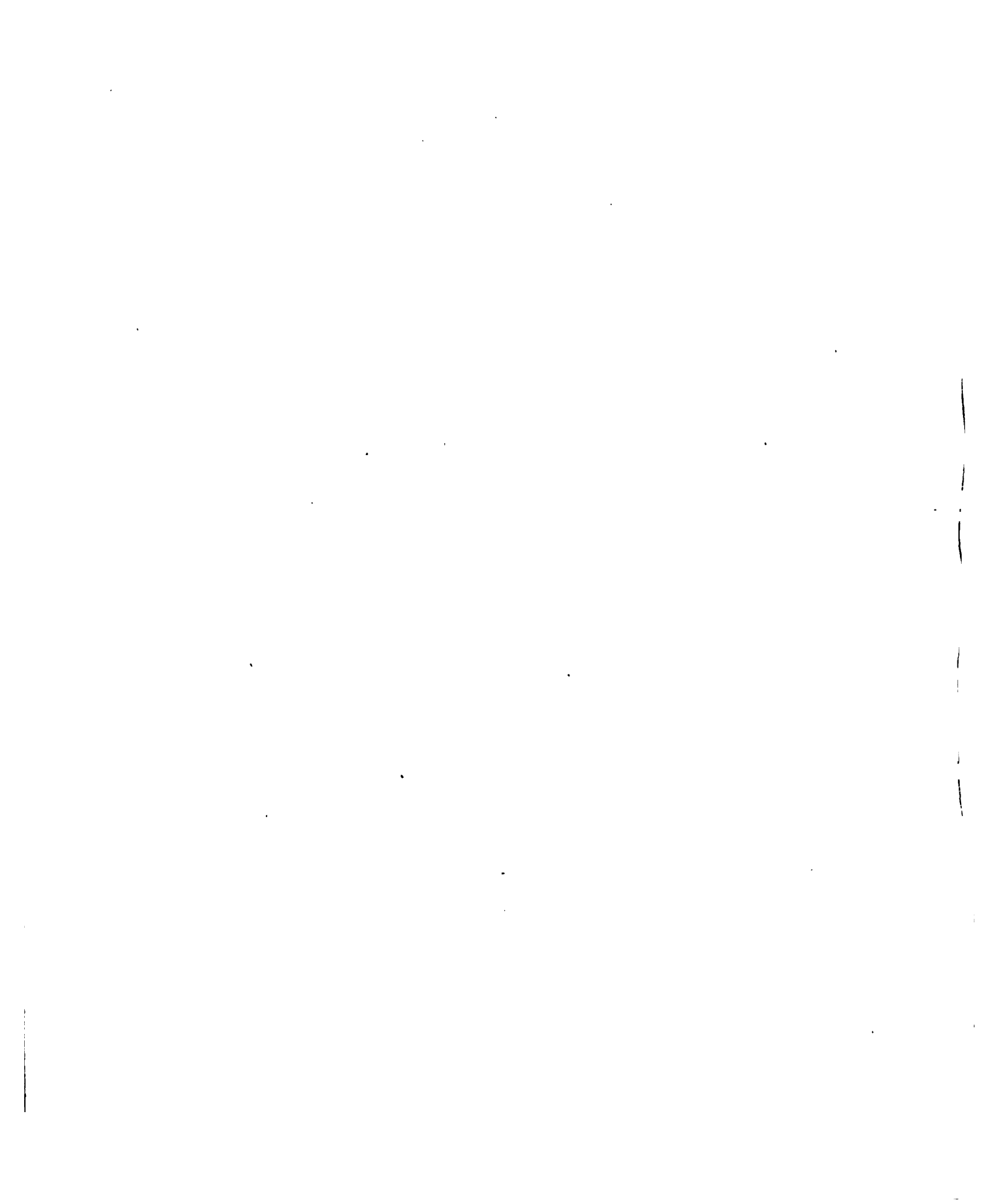
Fig. 2.

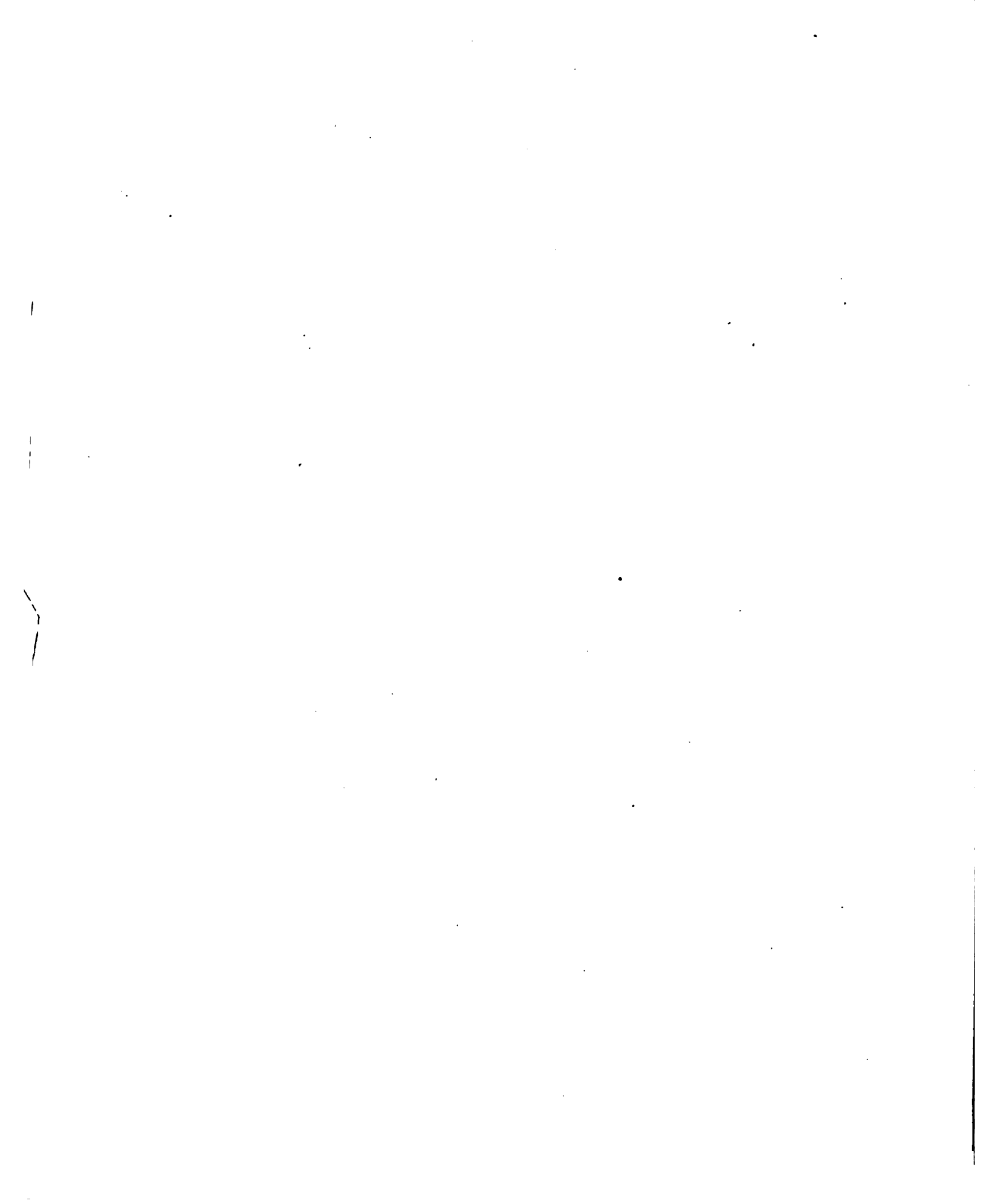
Fig. 3.



lle.

4 5 6 mètres.





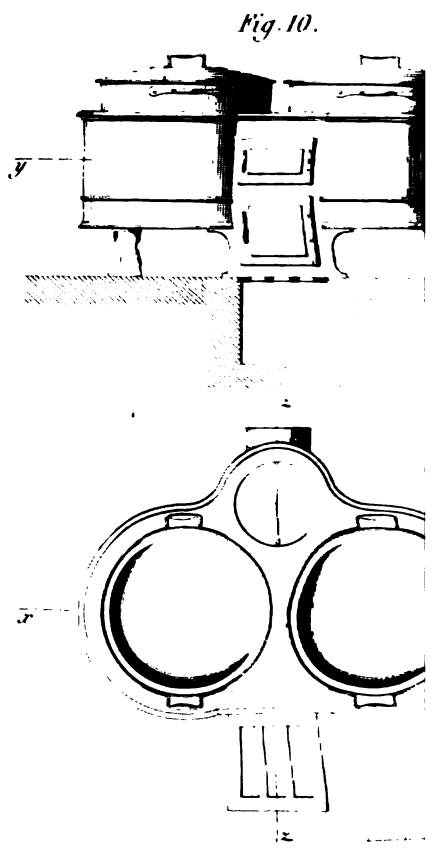
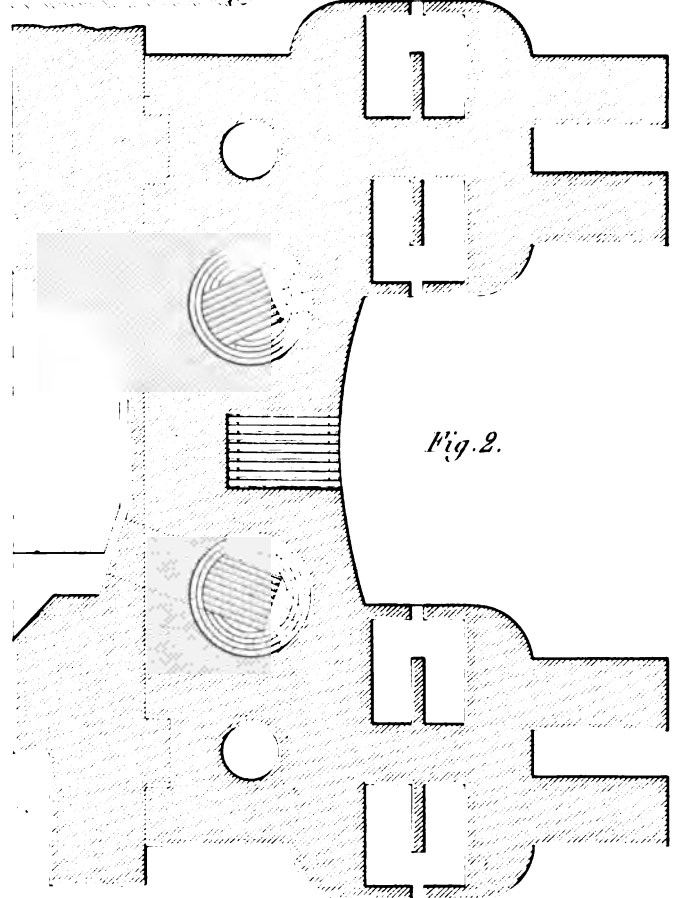
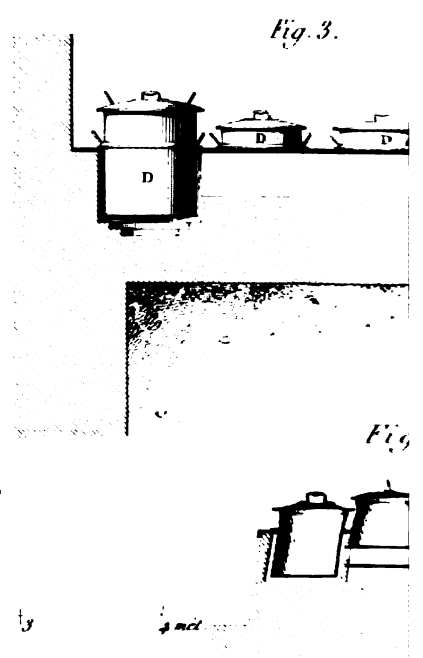
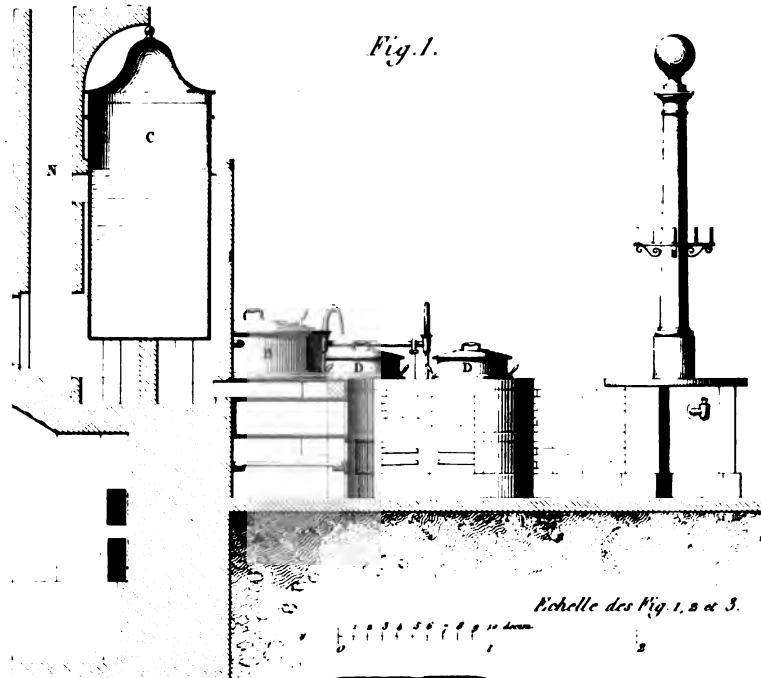


Fig. 4.

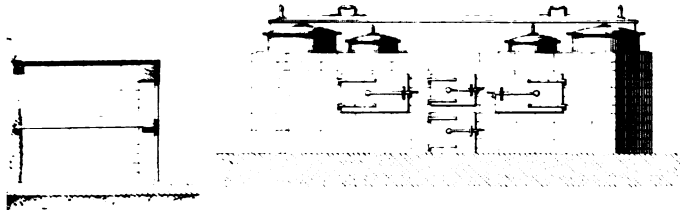


Fig. 5.

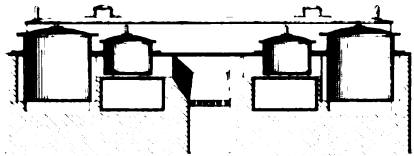


Fig. 6.

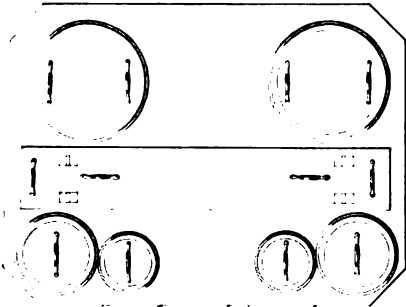
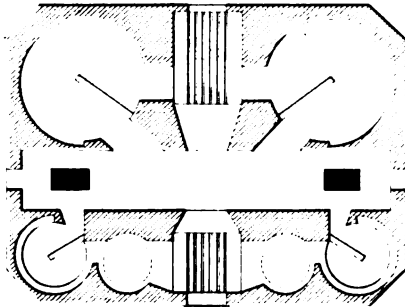


Fig. 7.



δ.

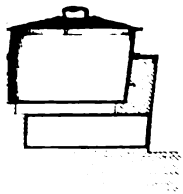


Fig. 12.

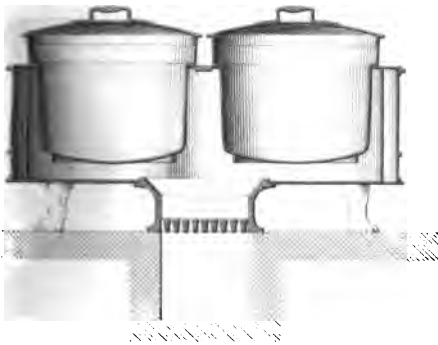


Fig. 14.

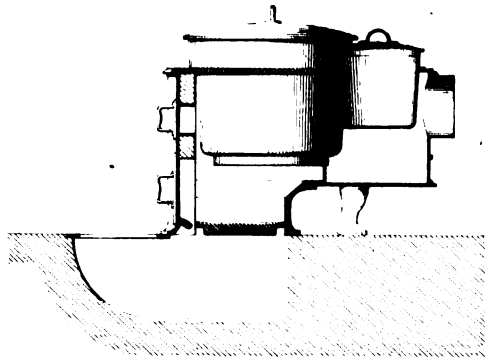


Fig. 11.



Fig. 13.

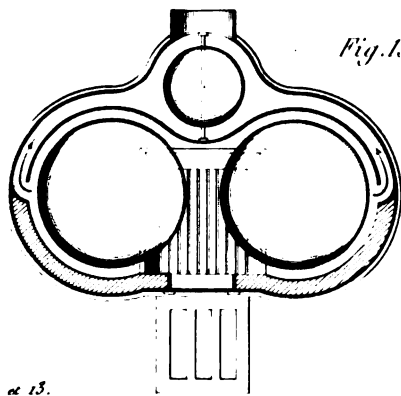
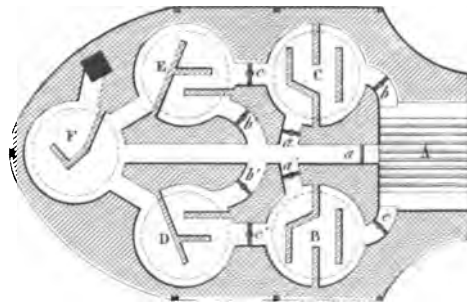
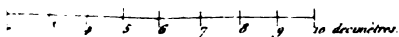


Fig. 9.

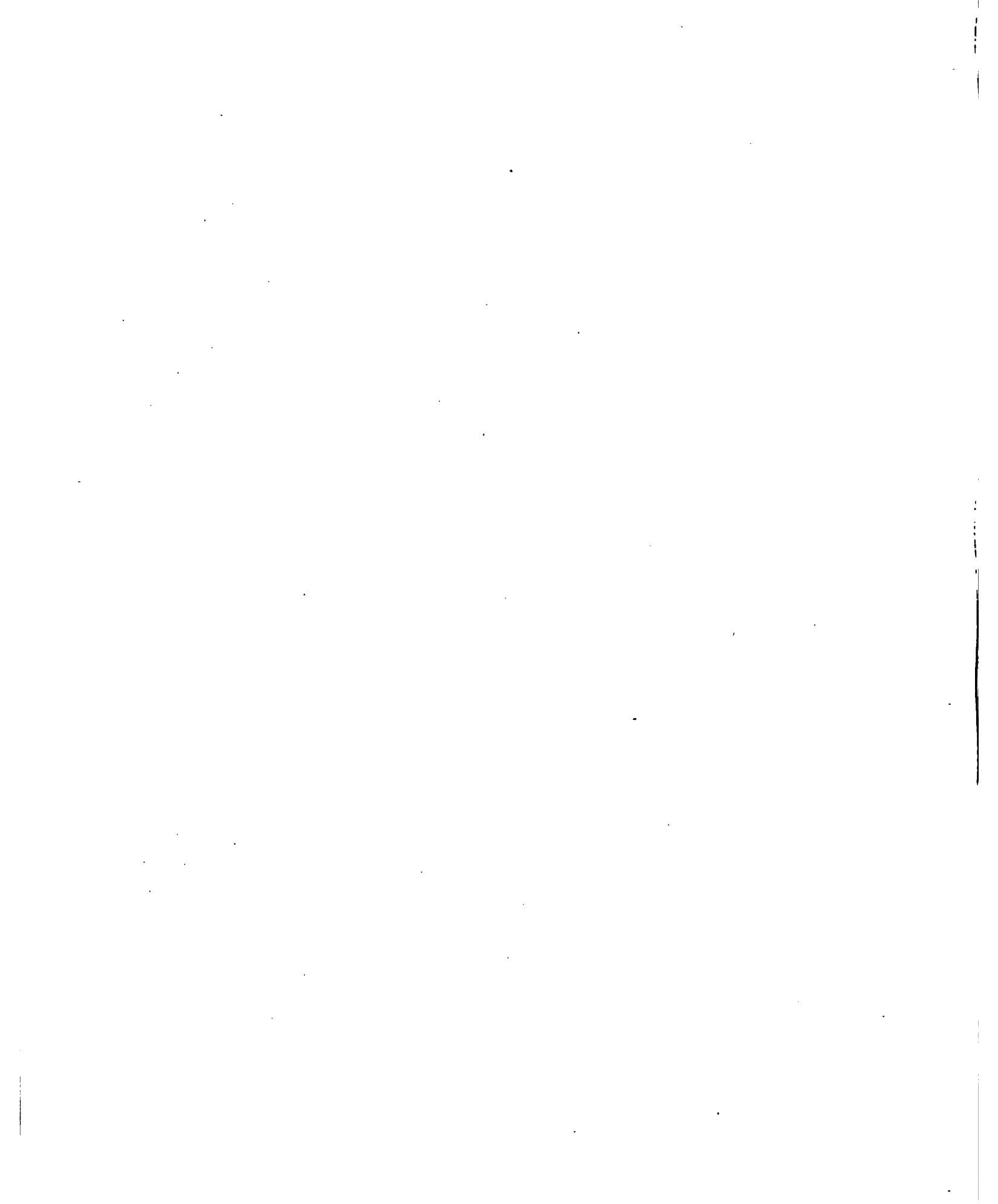


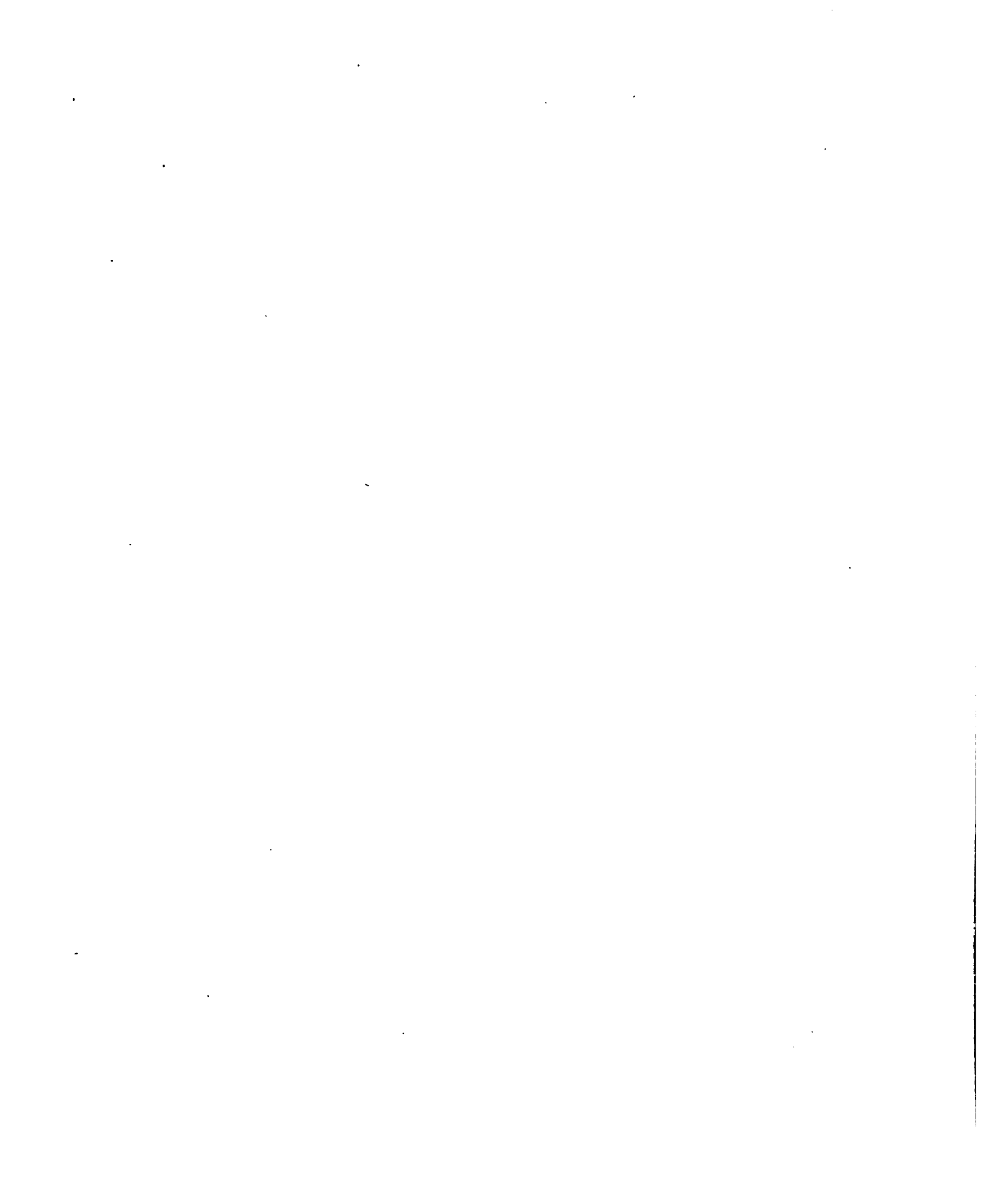
Echelle des Fig. 10, 11, 12 et 13.



Echelle des Fig. 4, 5, 6, 7, 8 et 9.







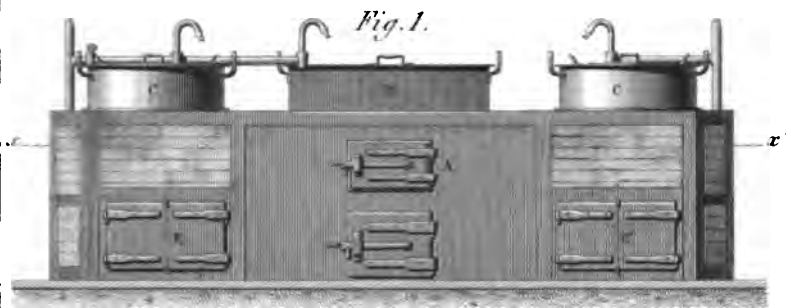


Fig. 1.

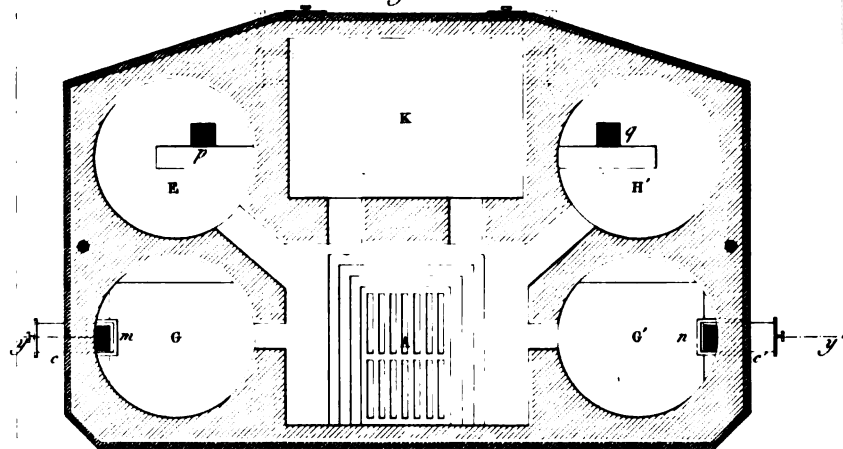
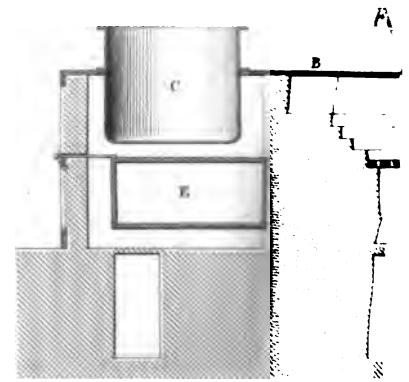


Fig. 3.



Fig. 4.

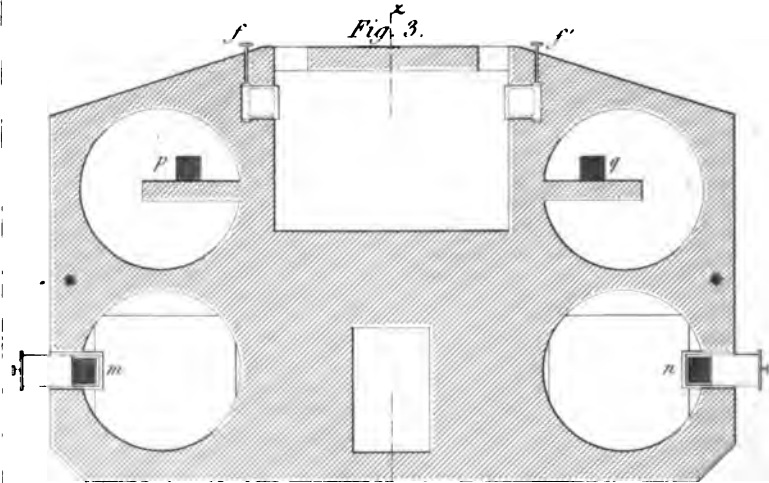


Fig. 5.

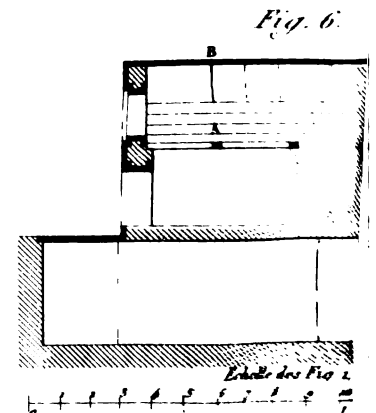


Fig. 6.

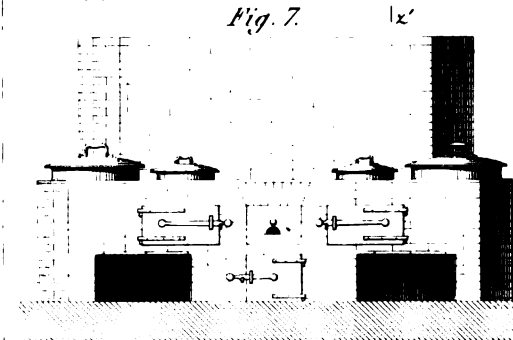


Fig. 7.

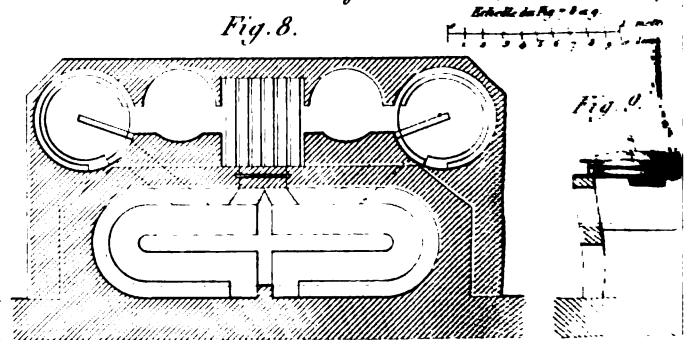


Fig. 8.

Fig. 9.

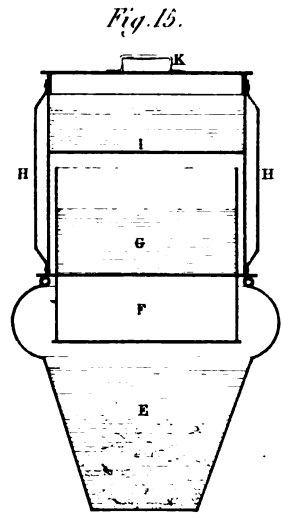
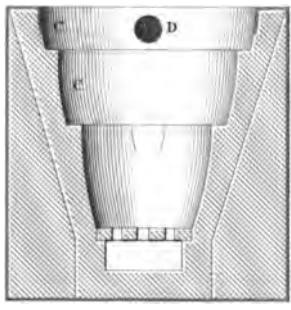
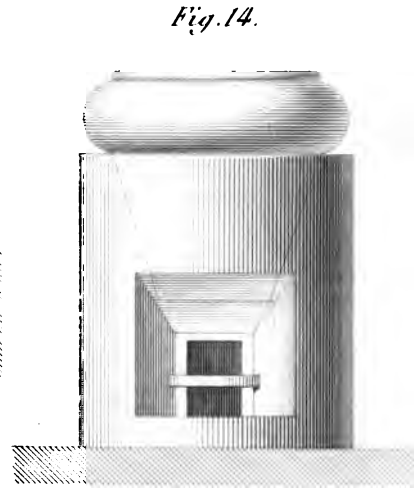
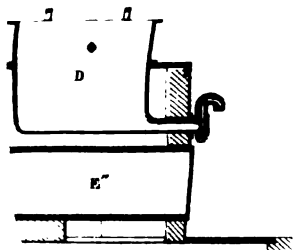
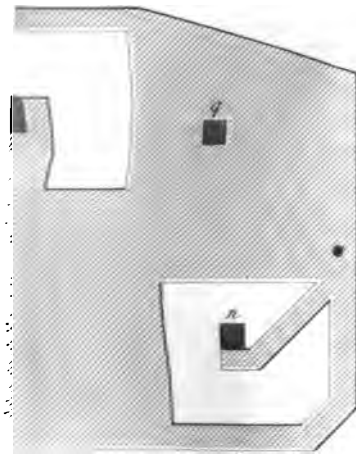
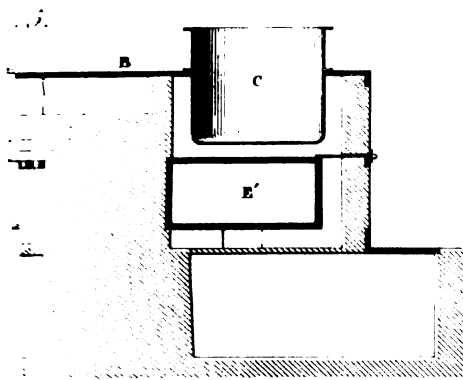
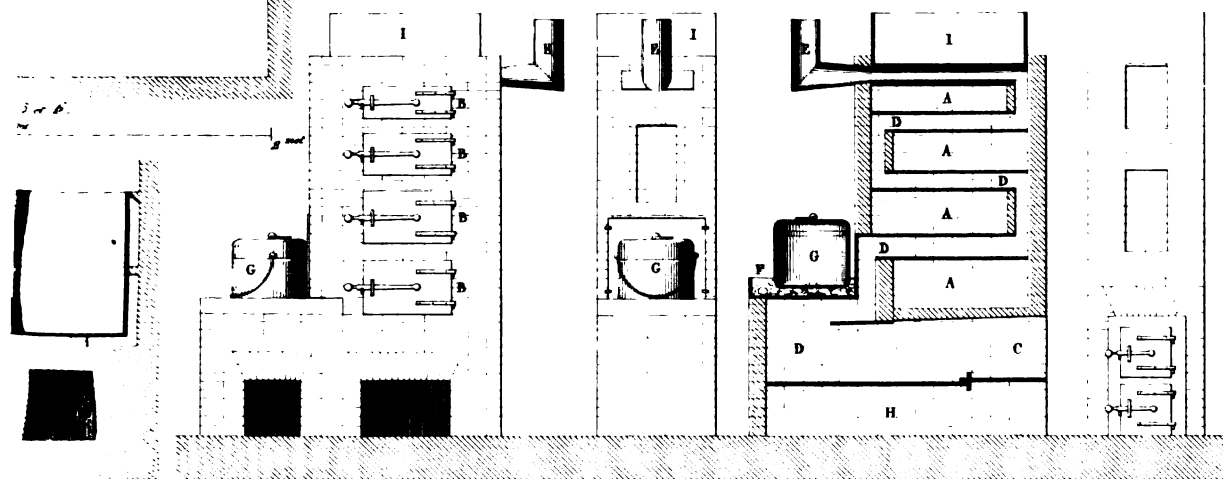


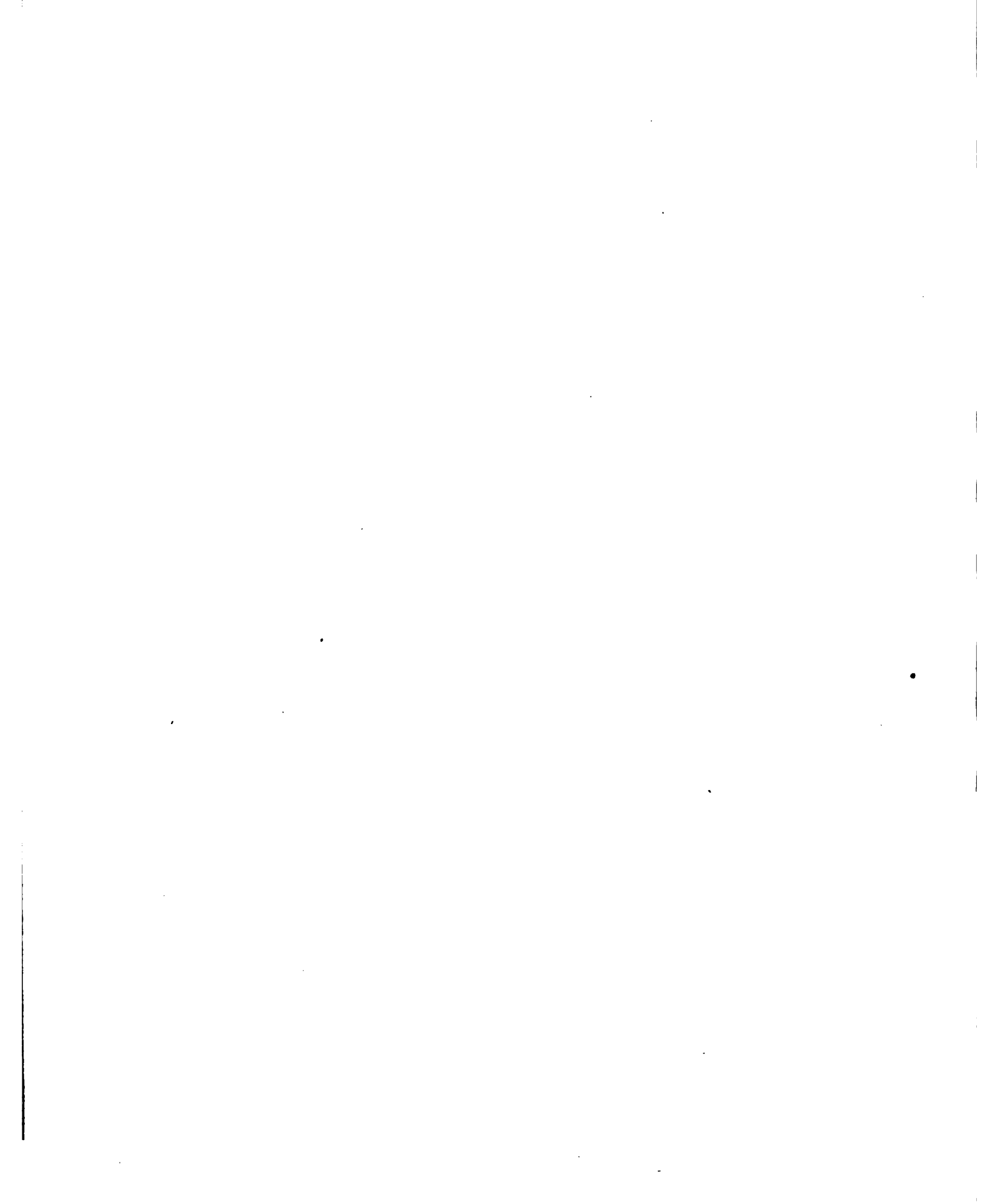
Fig. 10.

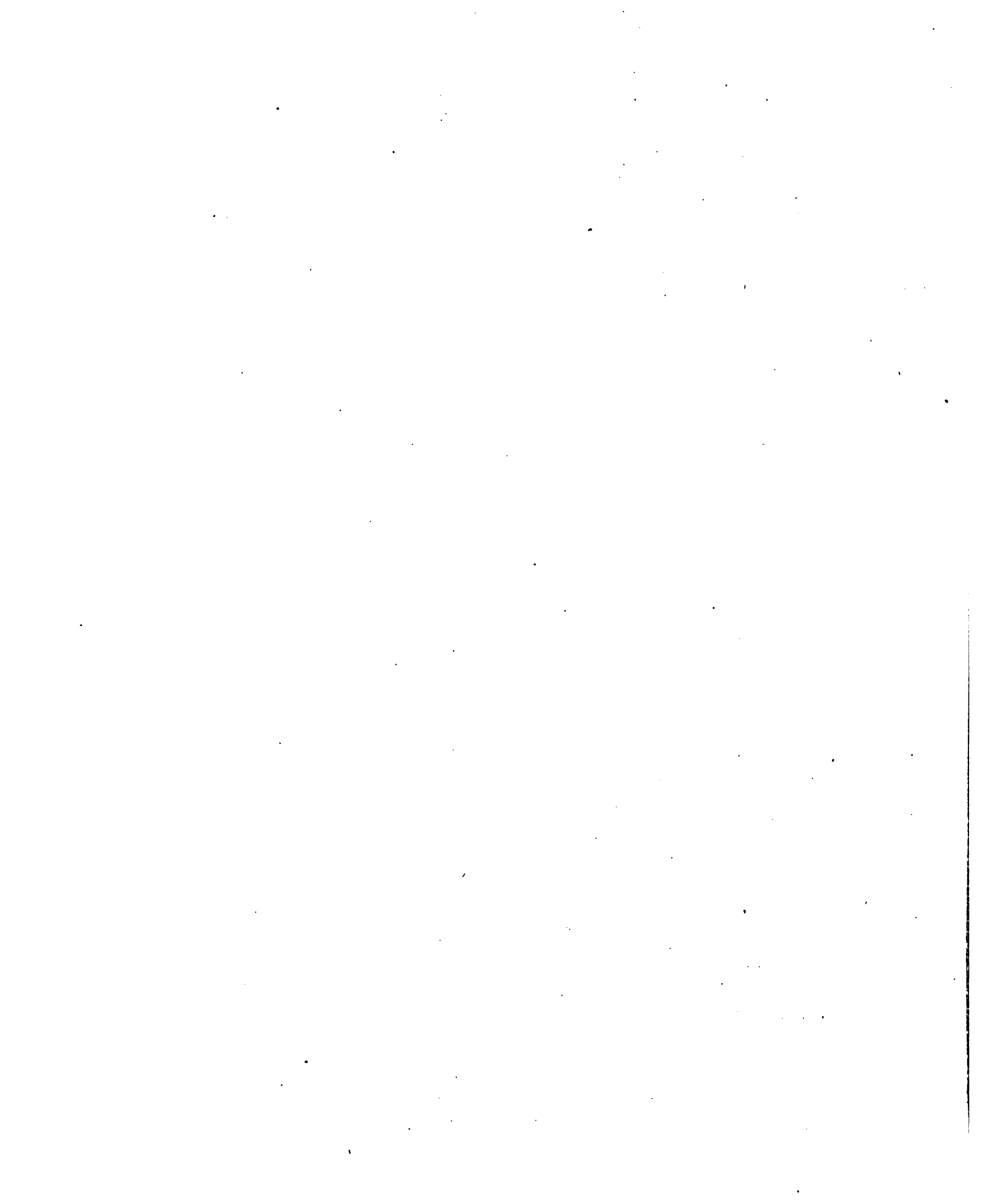
Fig. 11.

Fig. 12.

Fig. 13.







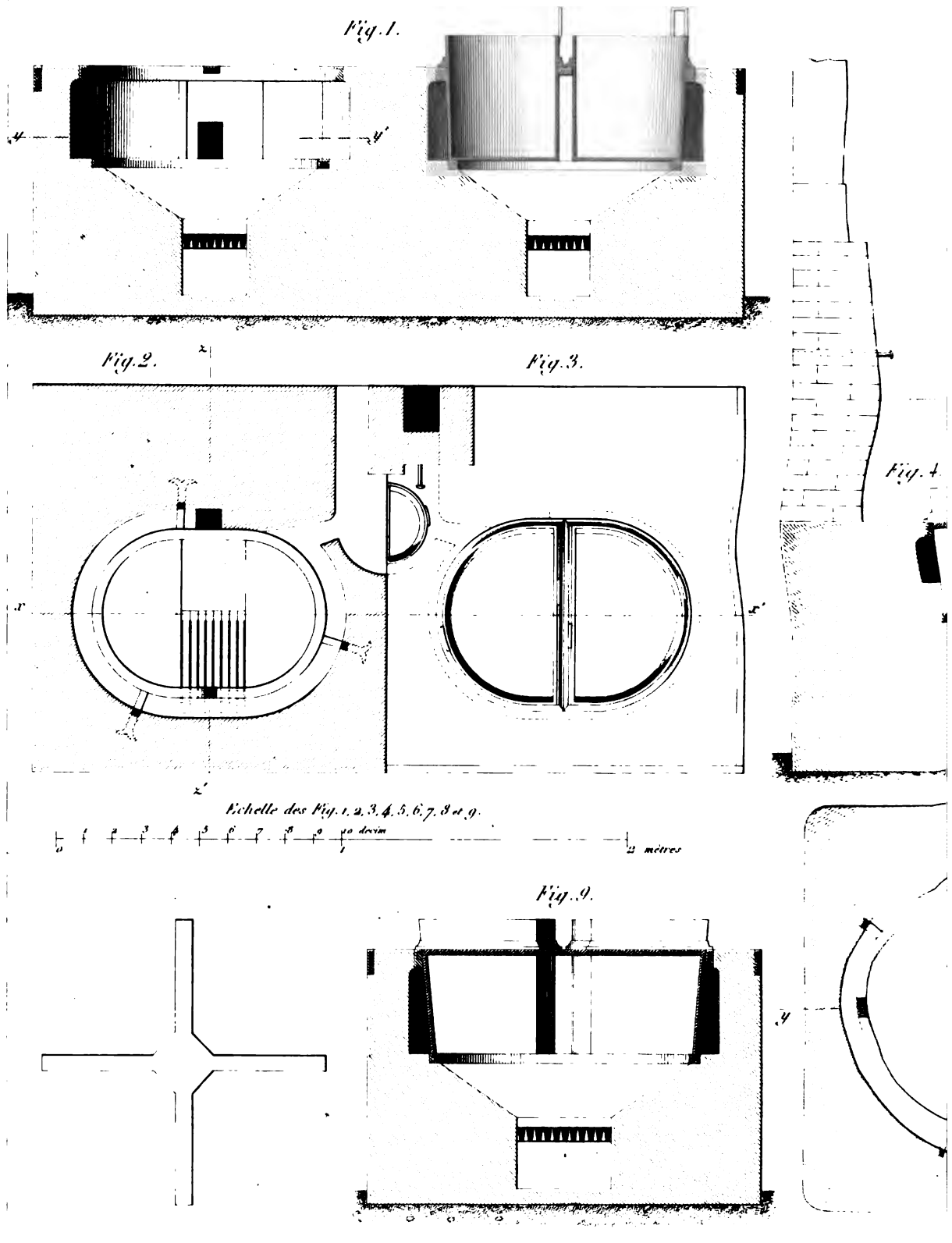


Fig. 5.

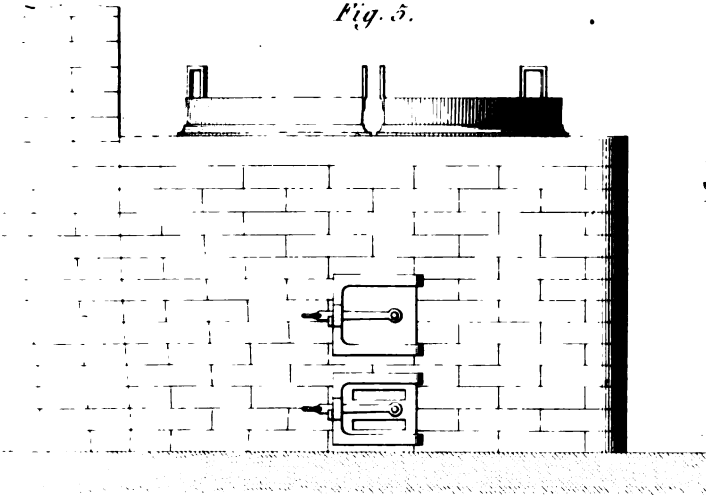


Fig. 10.

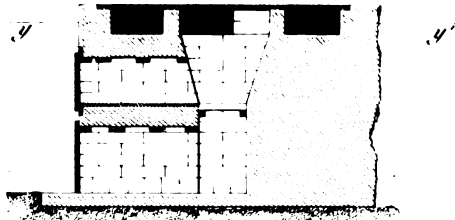


Fig. 11.

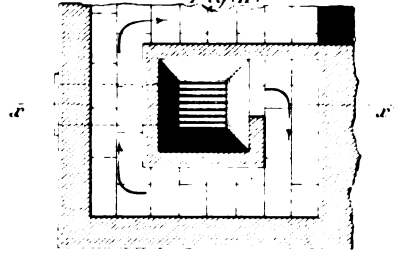


Fig. 6.

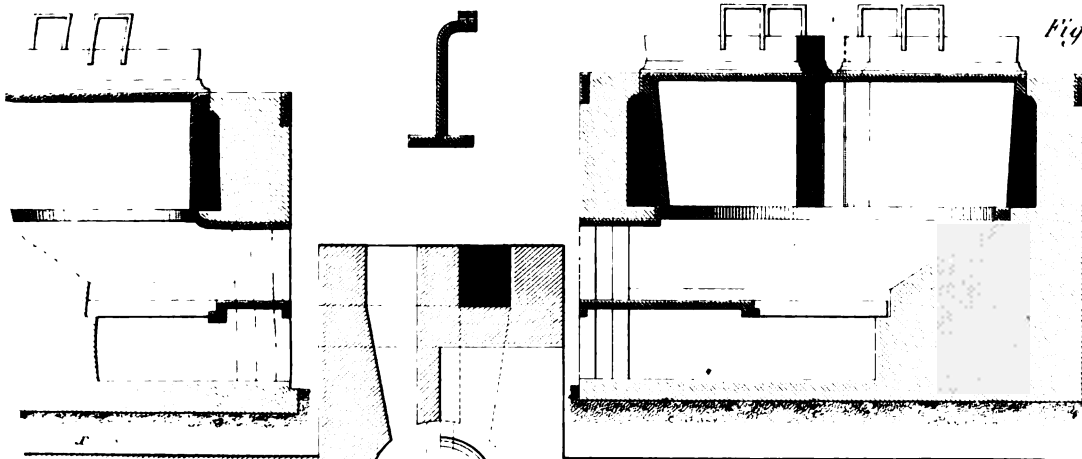
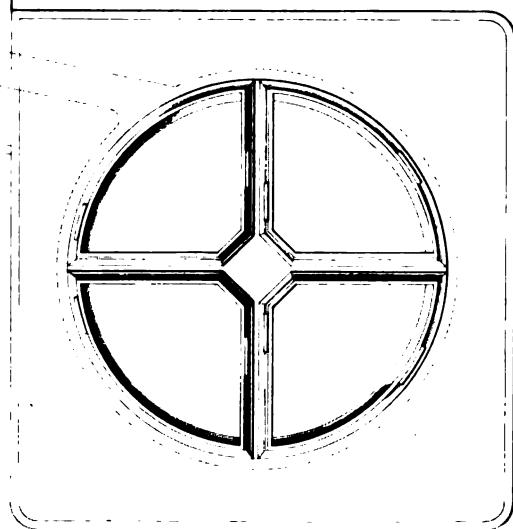
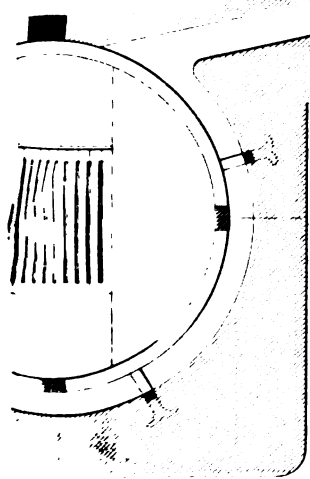
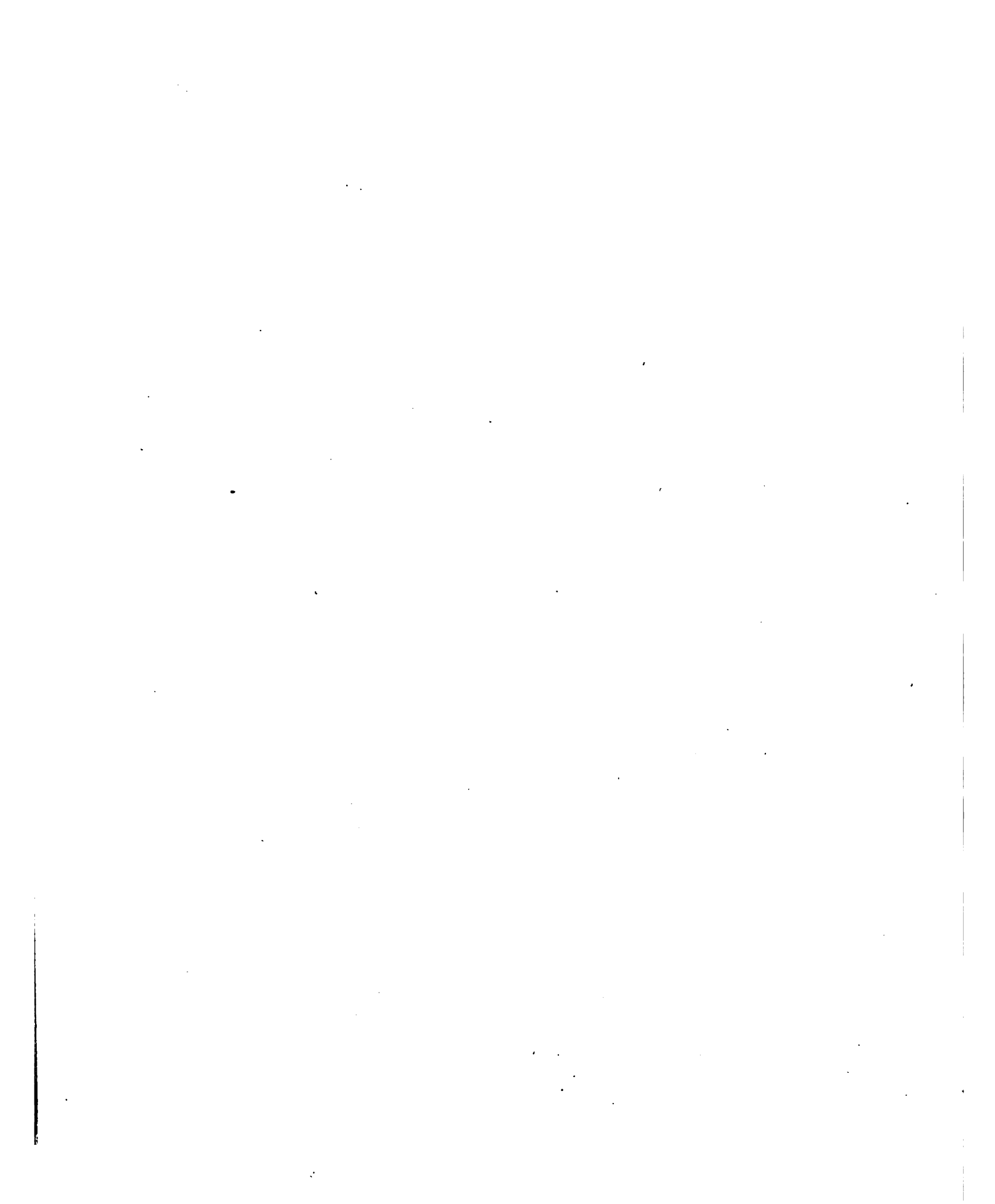
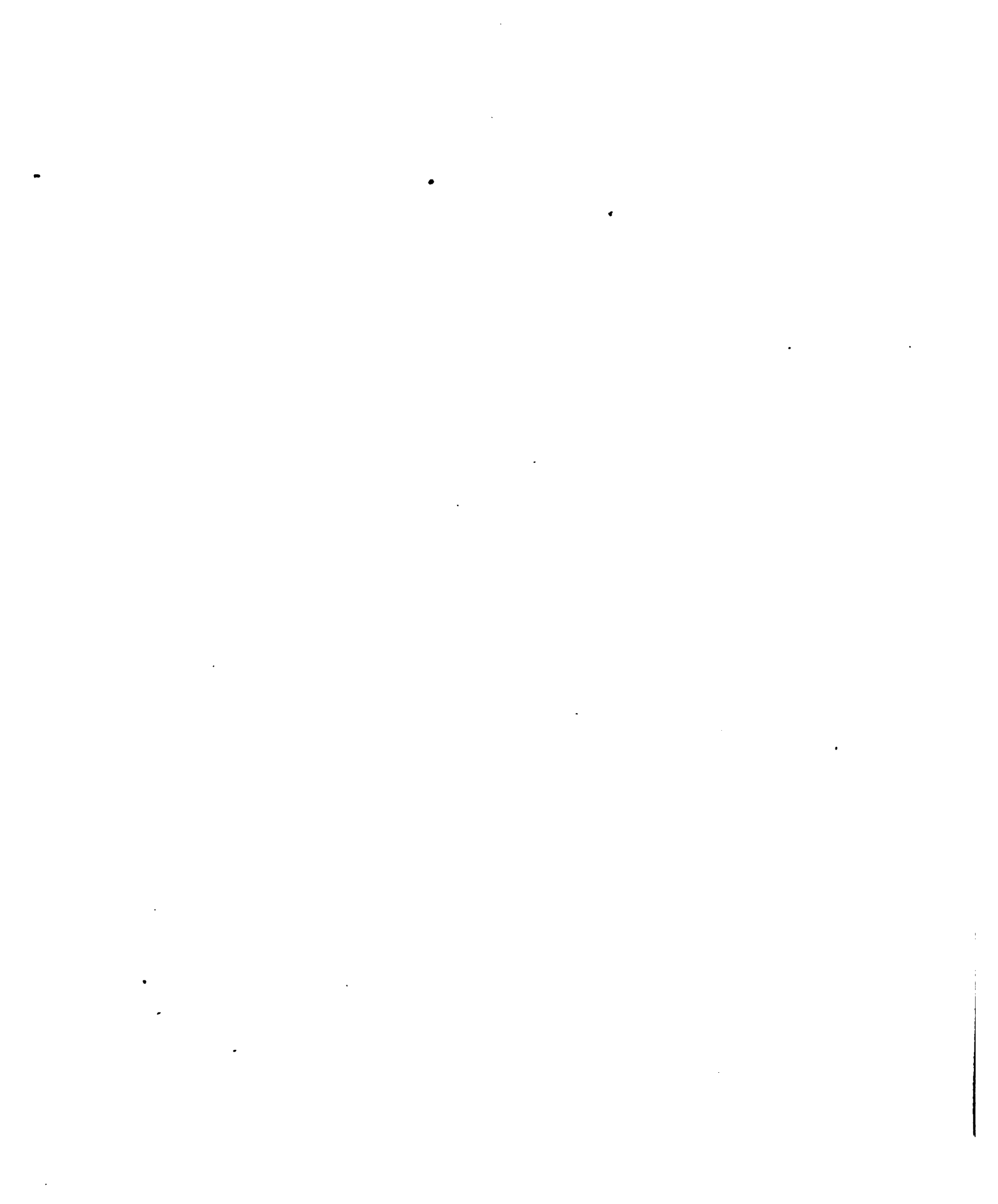


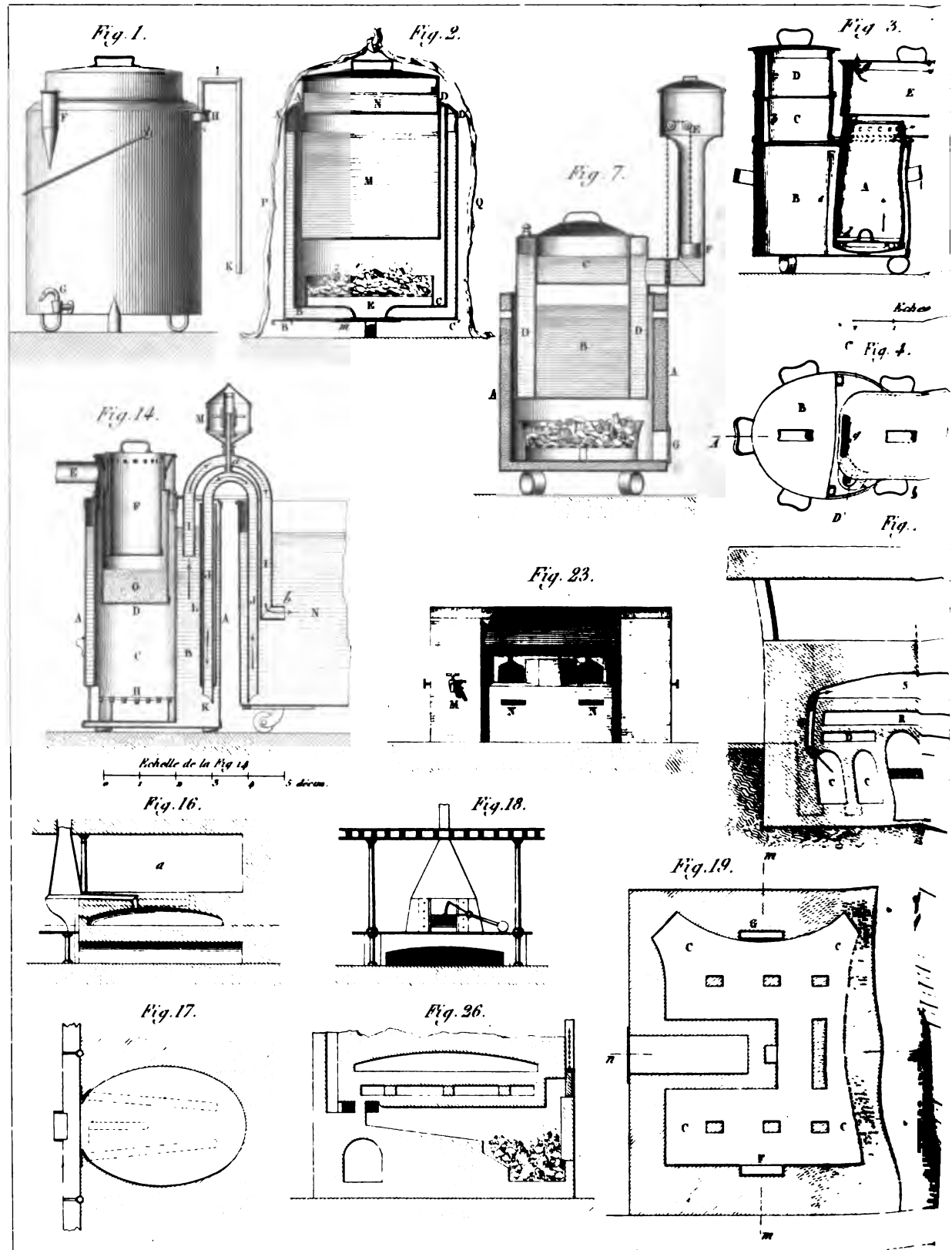
Fig. 7.

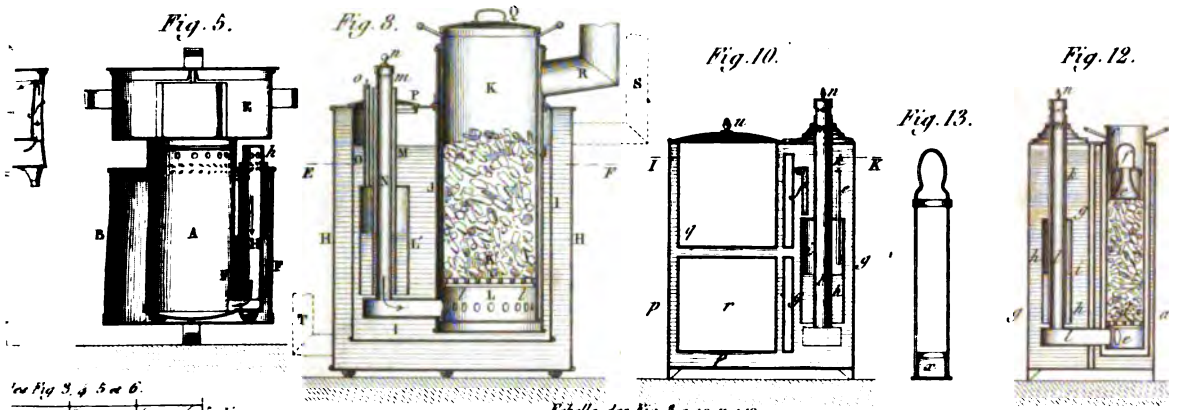
Fig. 8.





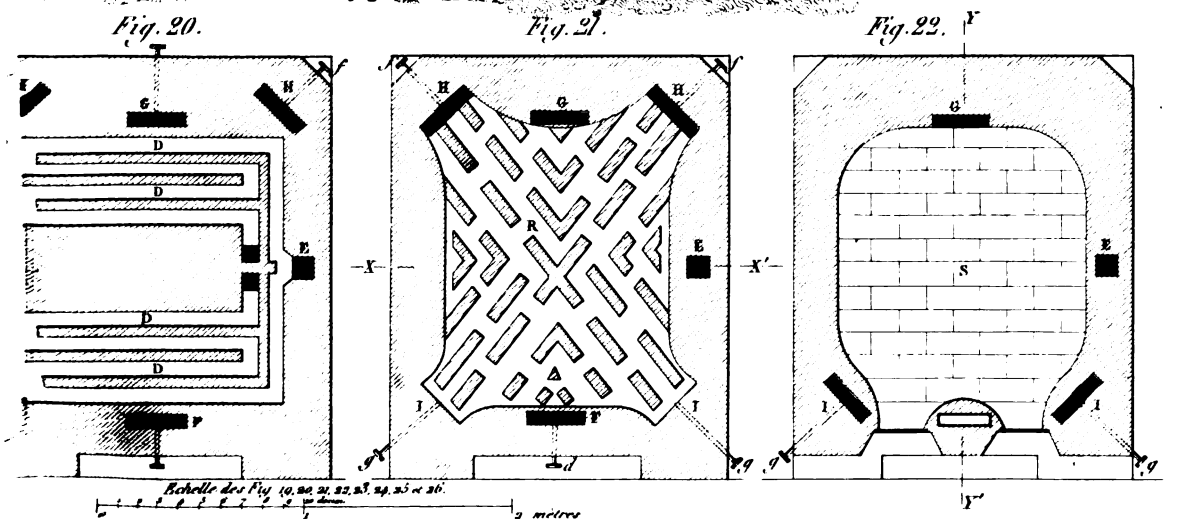
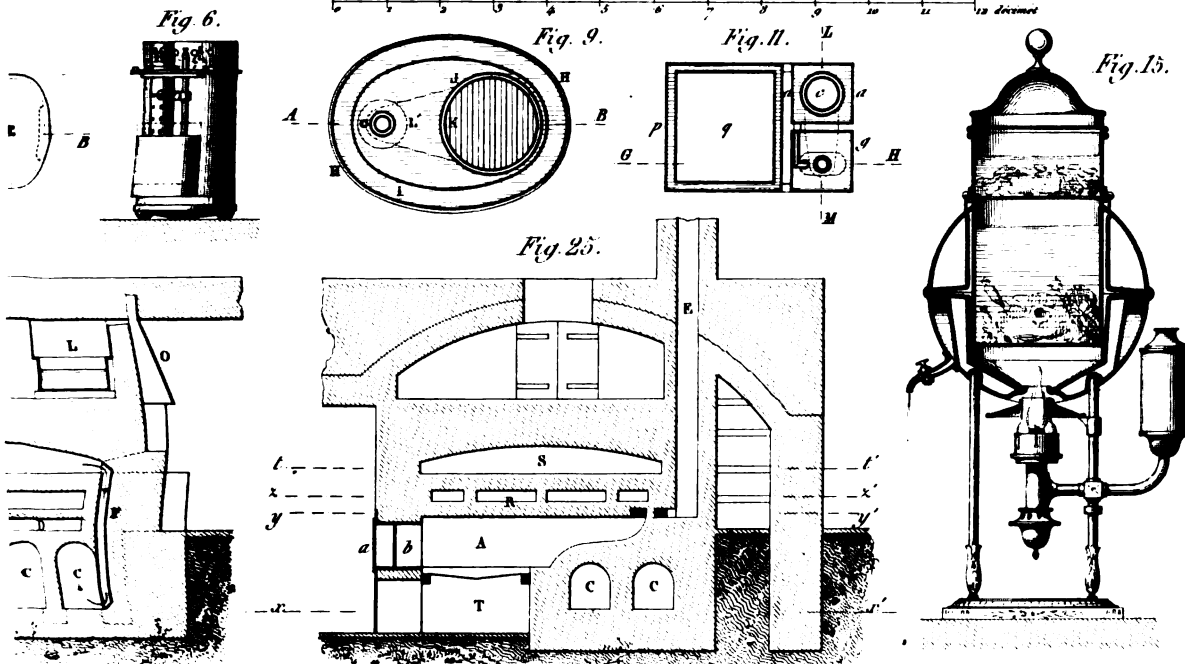






Les Fig. 5, 6 et 6.

Echelle des Fig. 8, 9, 10, 11 et 12.



Echelle des Fig. 20, 21, 22, 23, 24, 25 et 26.

5 mètres

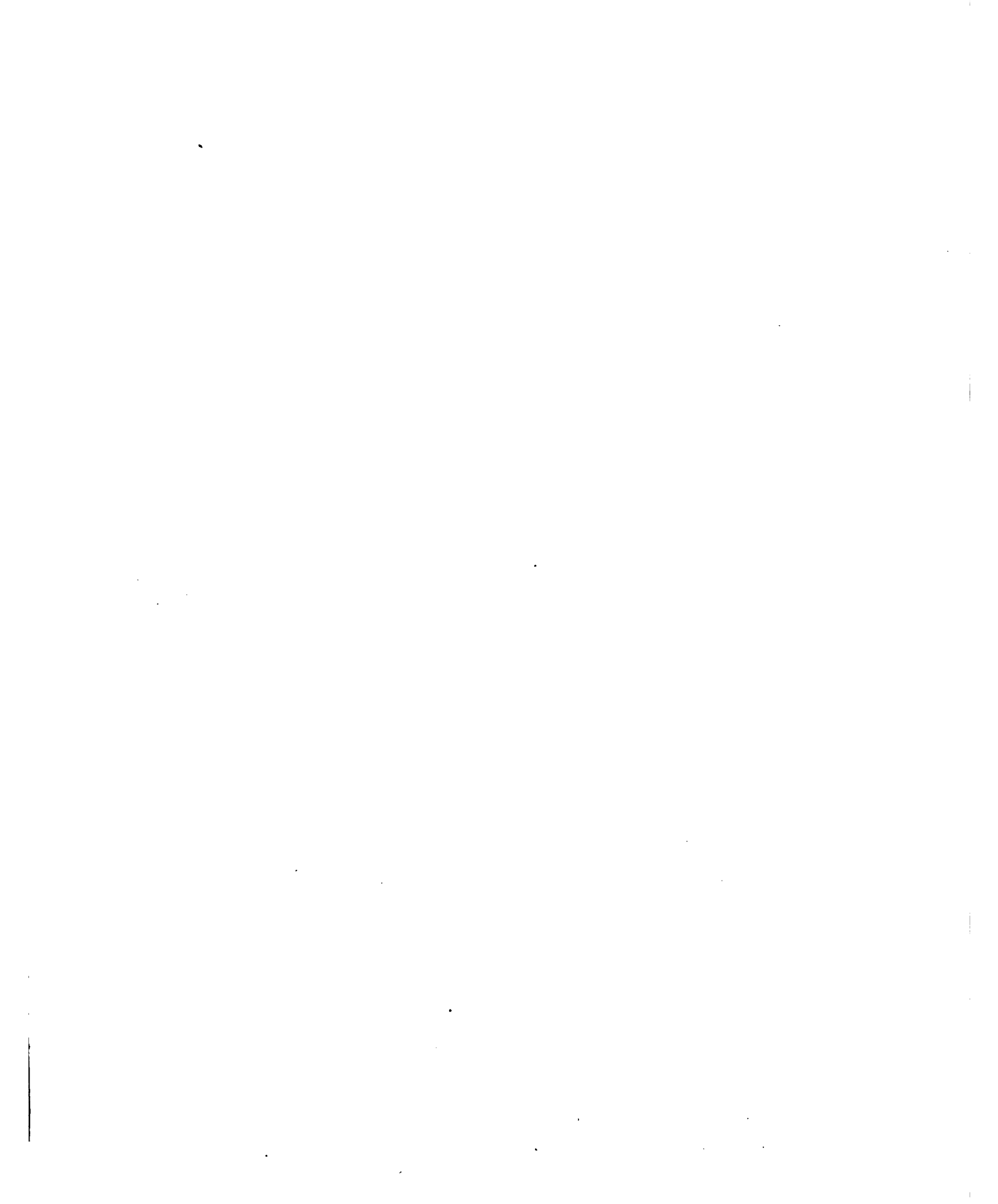




Fig. 1.

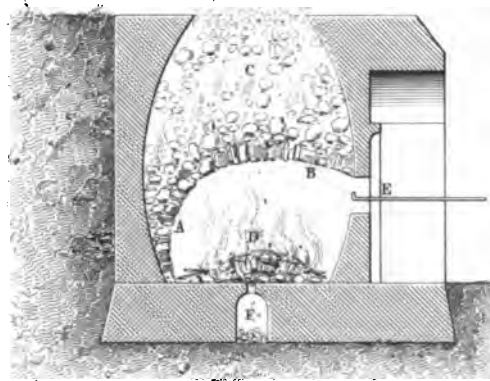


Fig. 6.

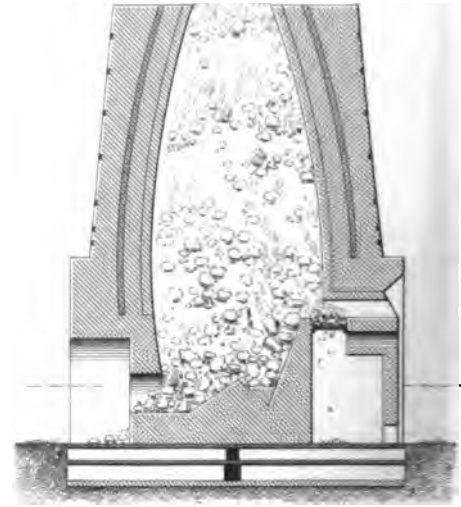


Fig. 14.

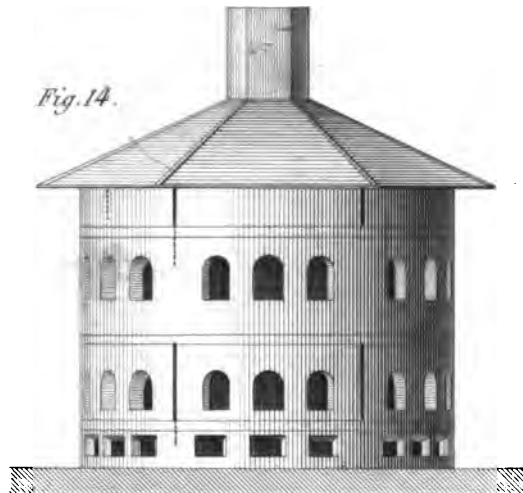


Fig. 15.

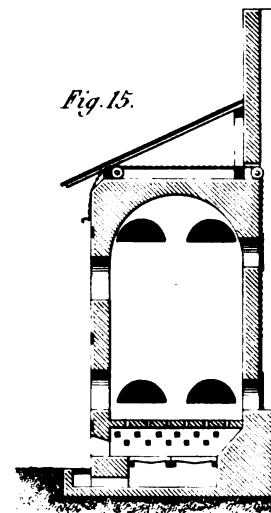


Fig. 16.

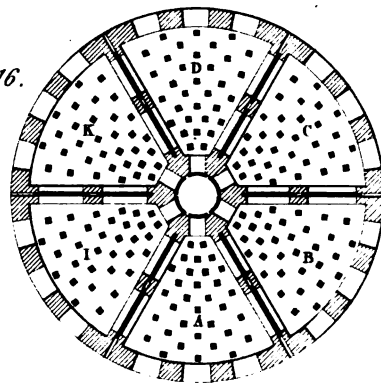


Fig. 11.

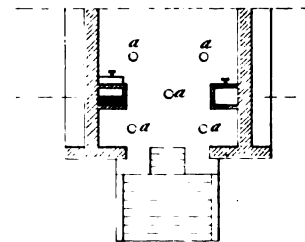


Fig. 9.

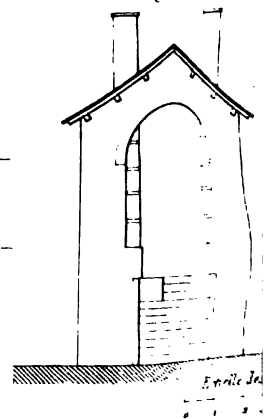


Fig. 5.

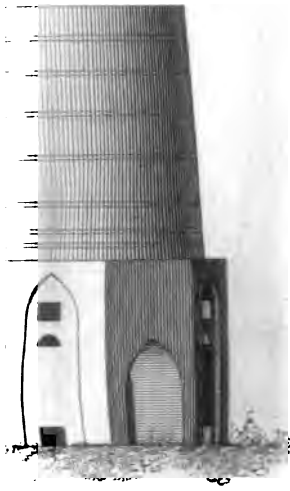


Fig. 4.

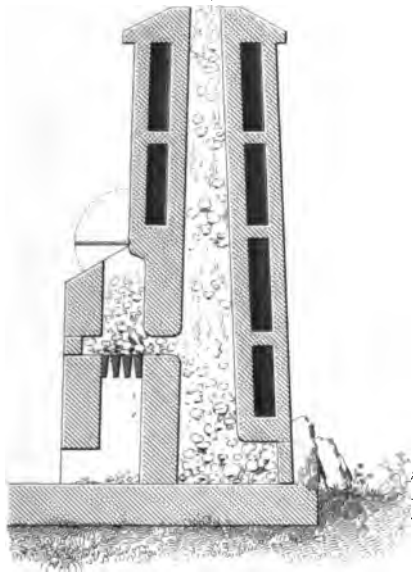


Fig. 2.

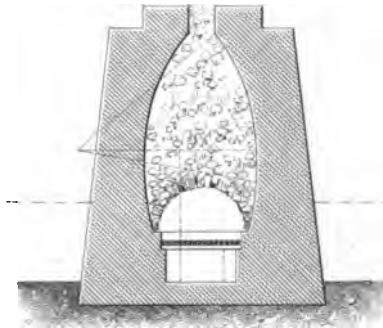


Fig. 7.

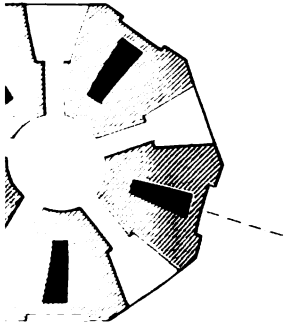


Fig. 3.

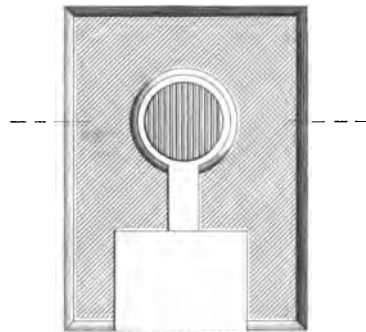
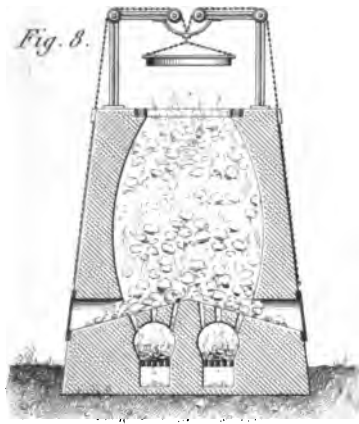
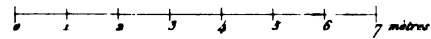


Fig. 8.



Echelle des Fig. 2 et 3.



les Fig. 5, 6 et 7.

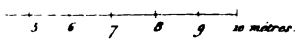


Fig. 12.

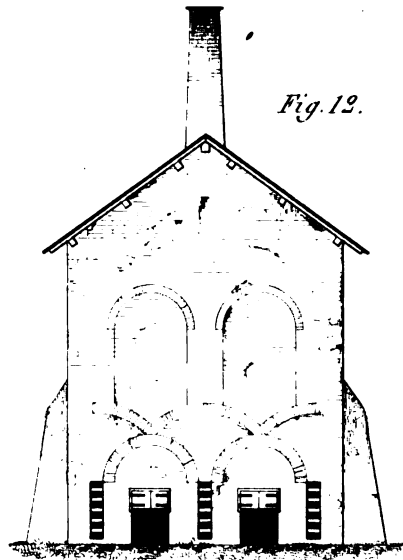


Fig. 10.

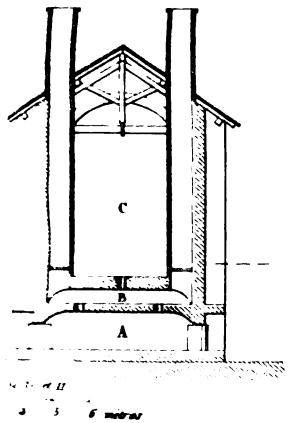
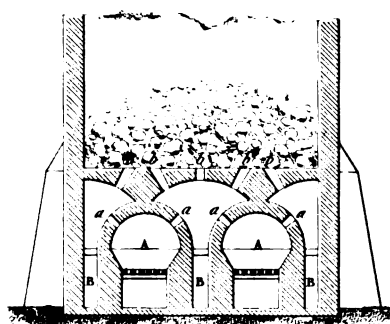
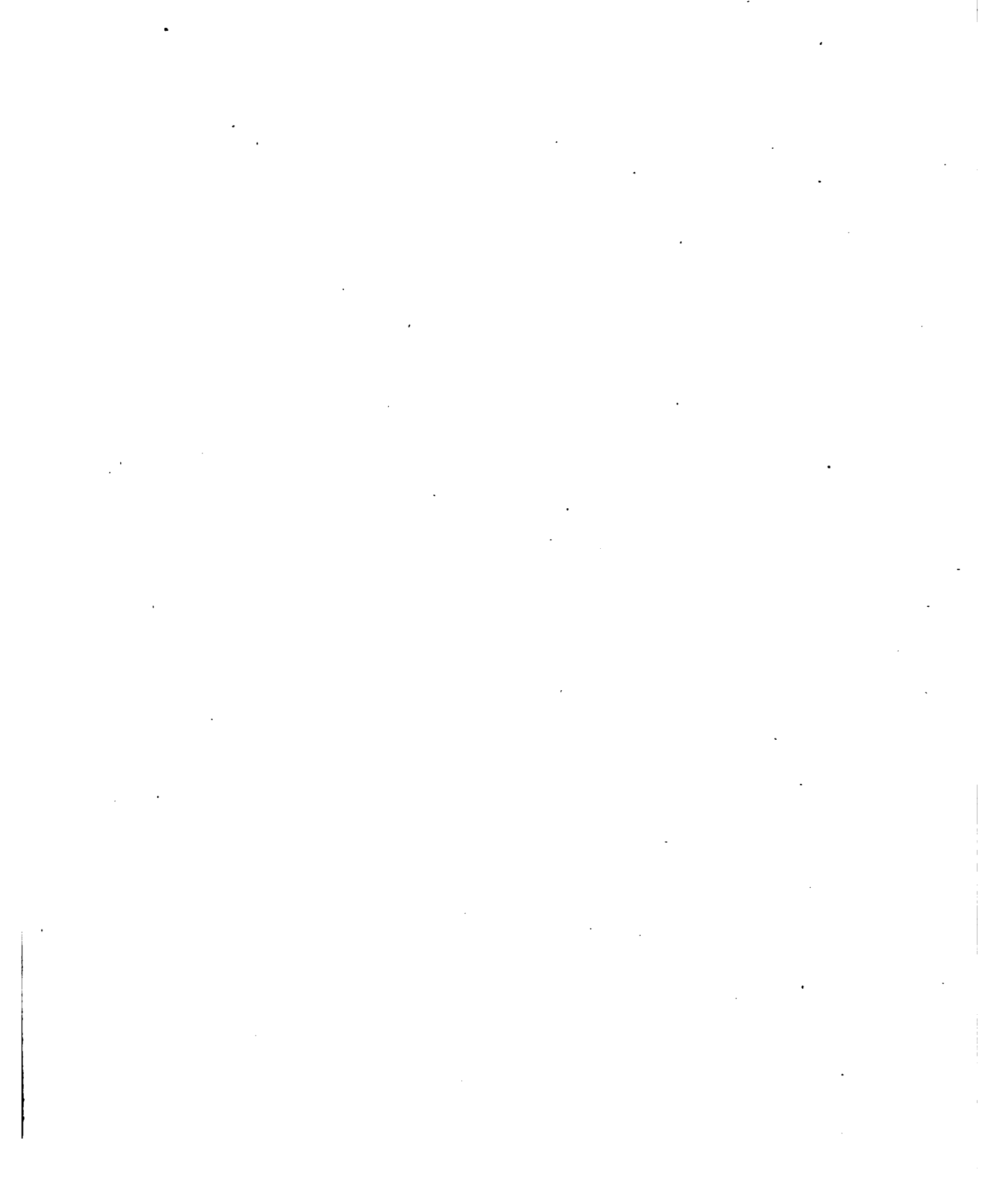
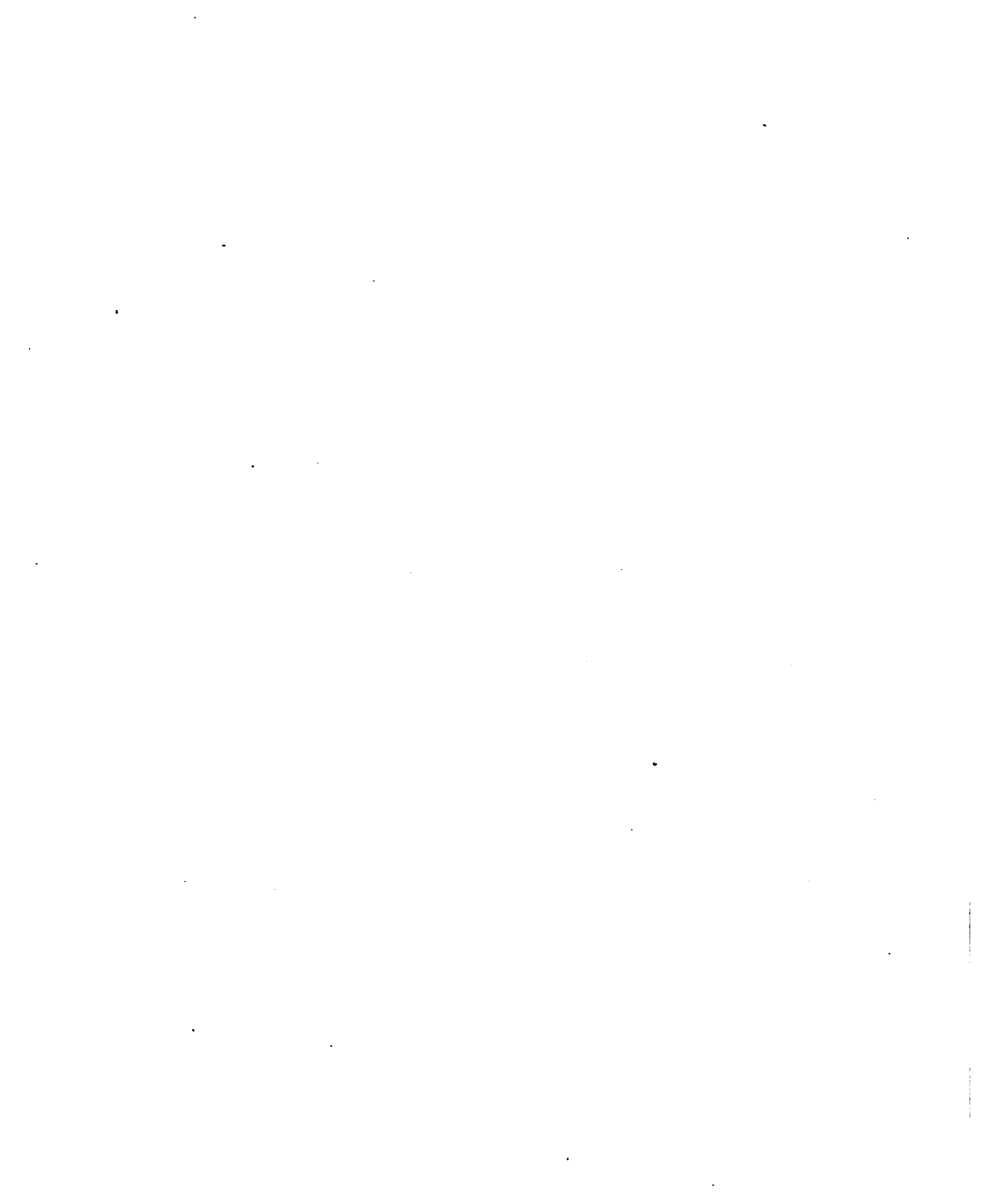


Fig. 13.







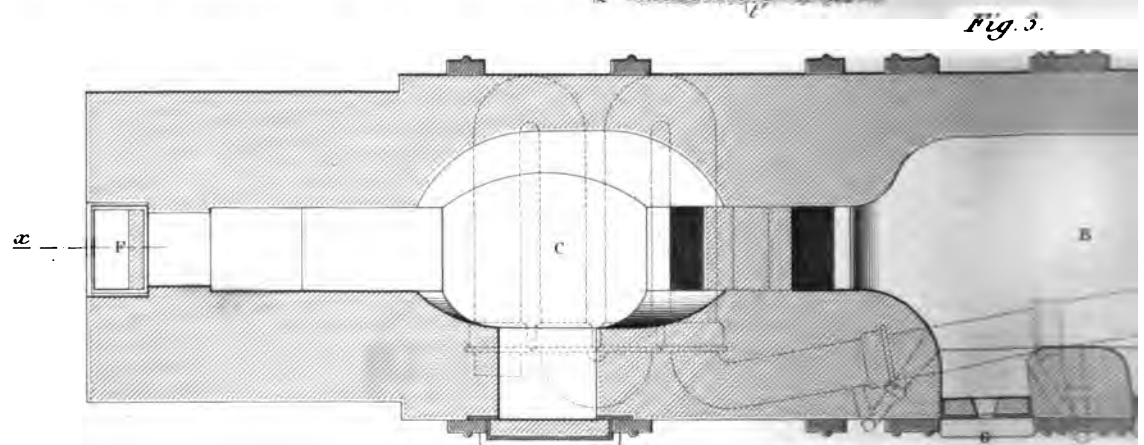
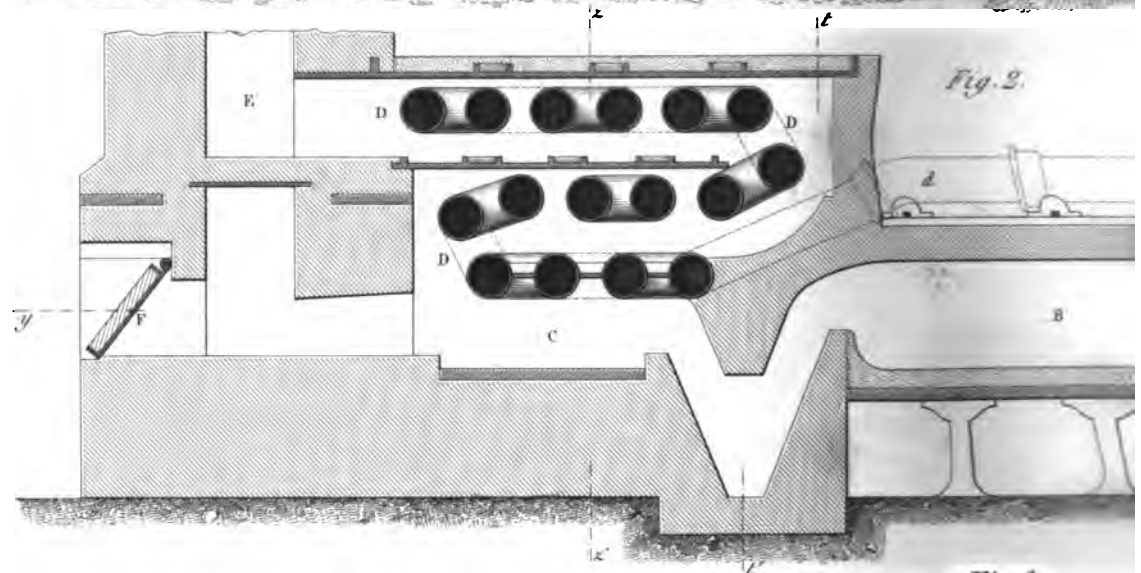
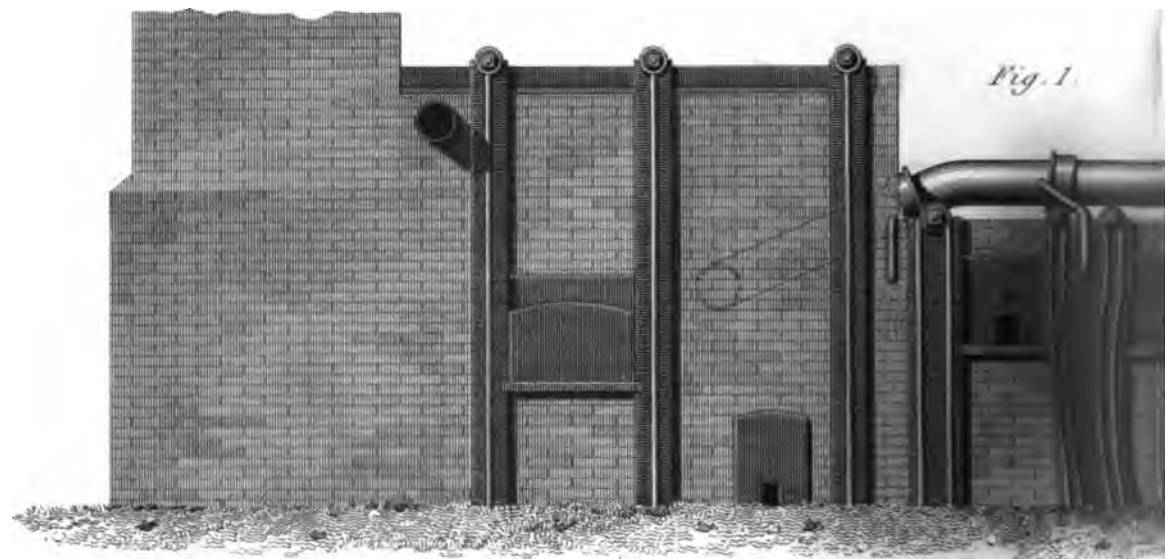


Fig. 4.

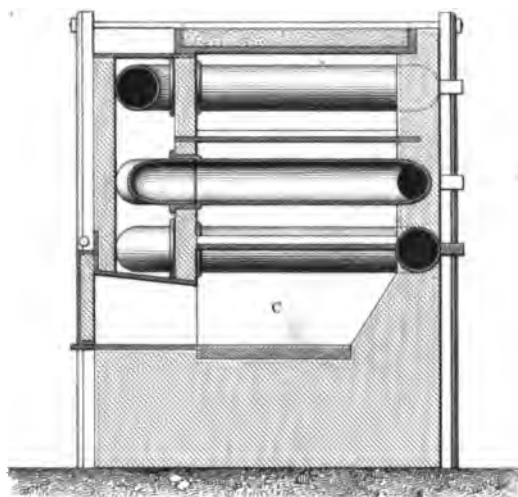
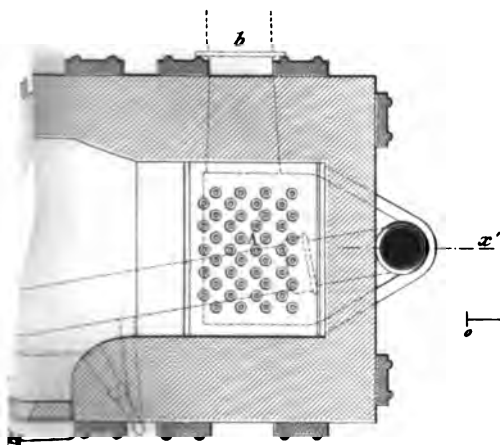
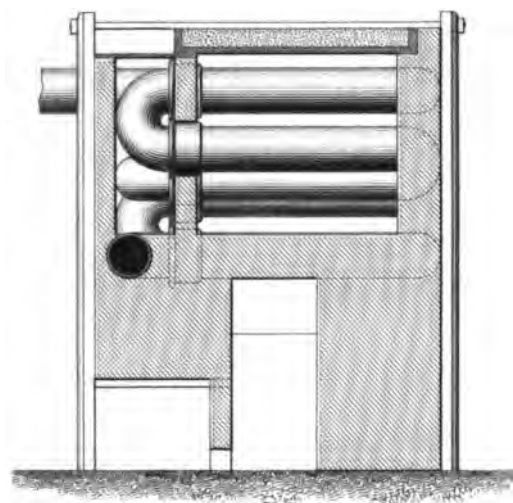
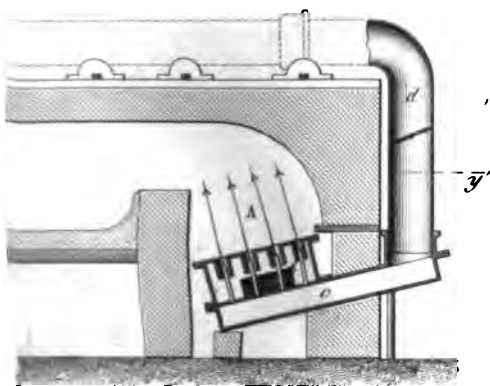
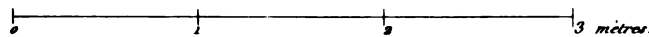


Fig. 5.



Echelle.



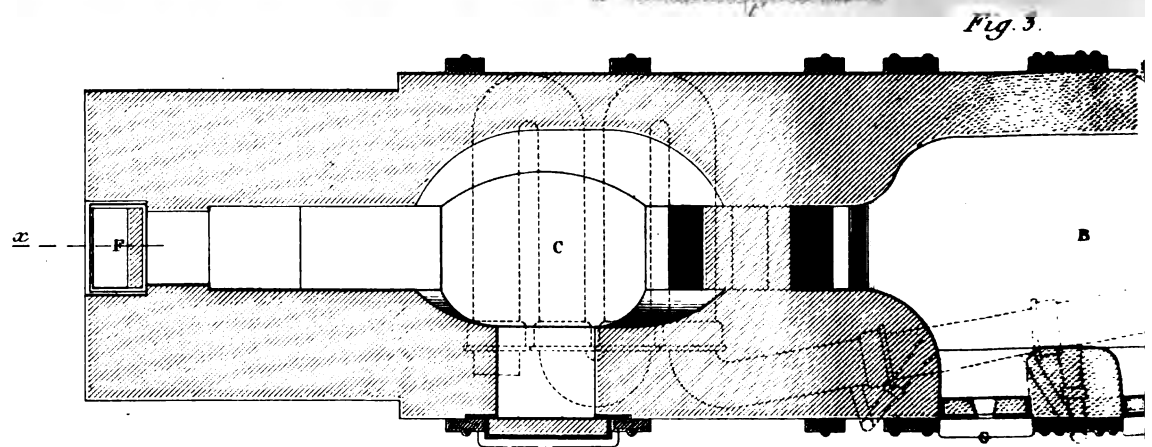
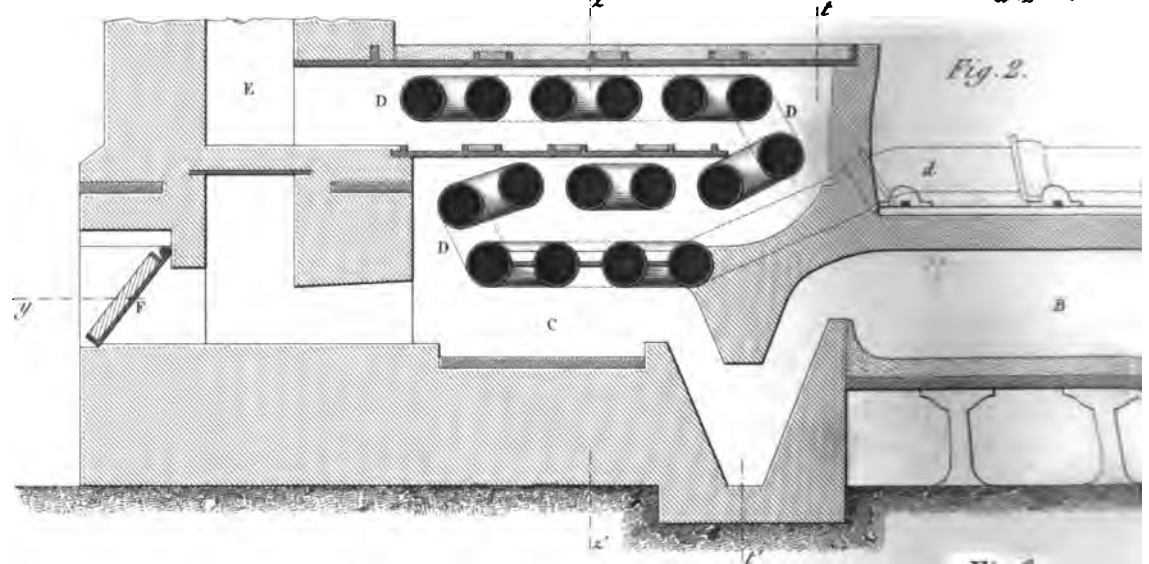
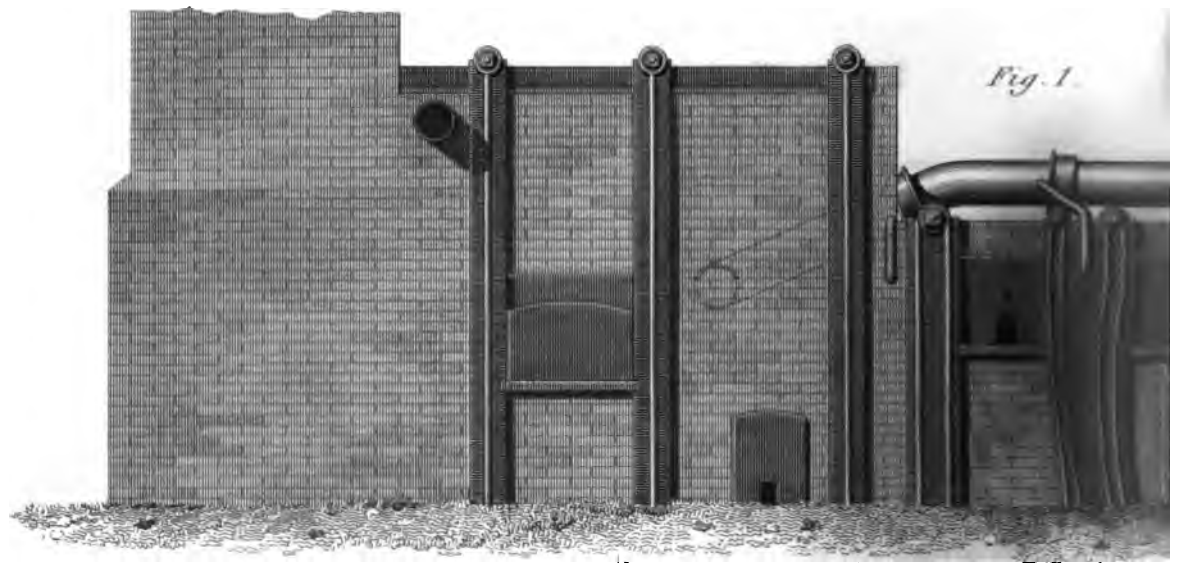


Fig. 4.

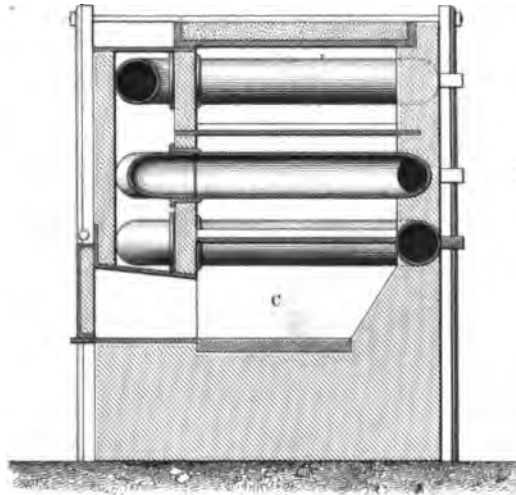
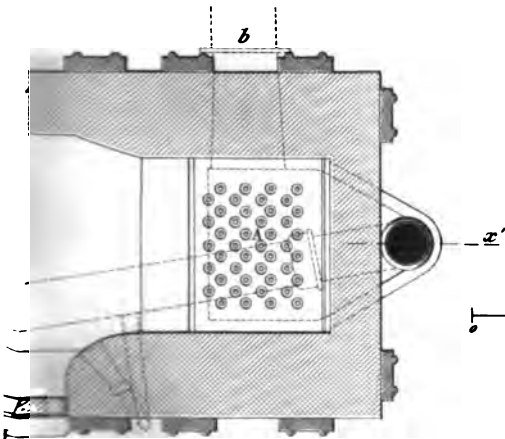
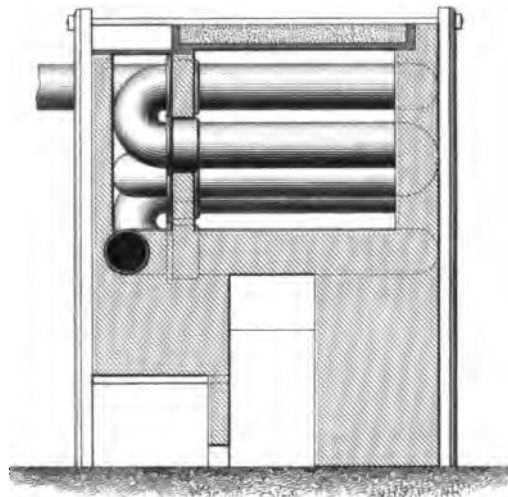
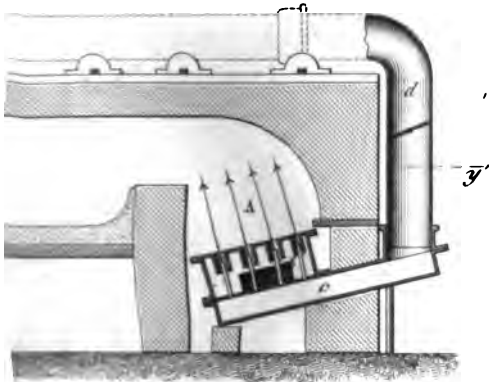
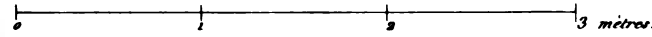
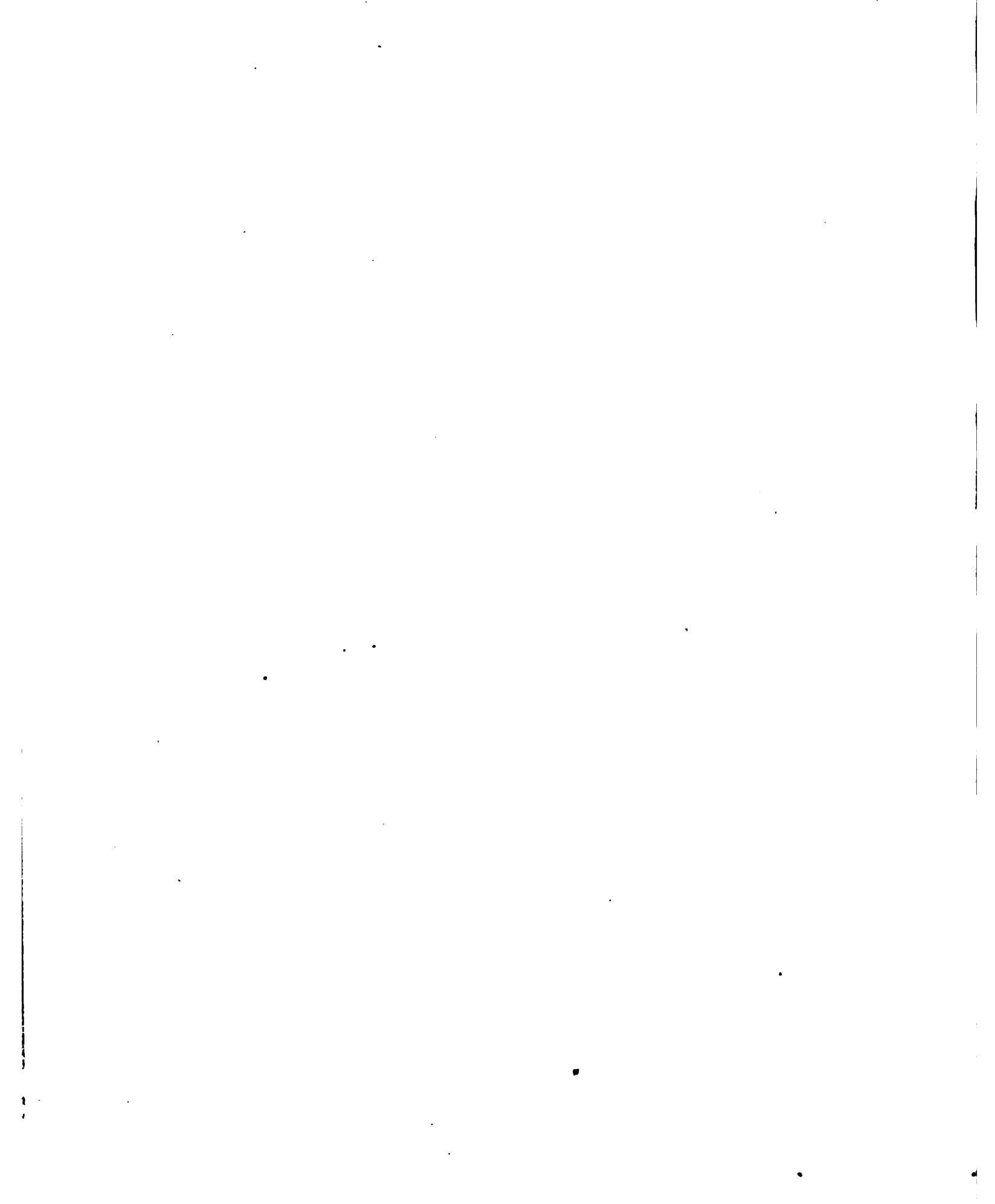


Fig. 5.

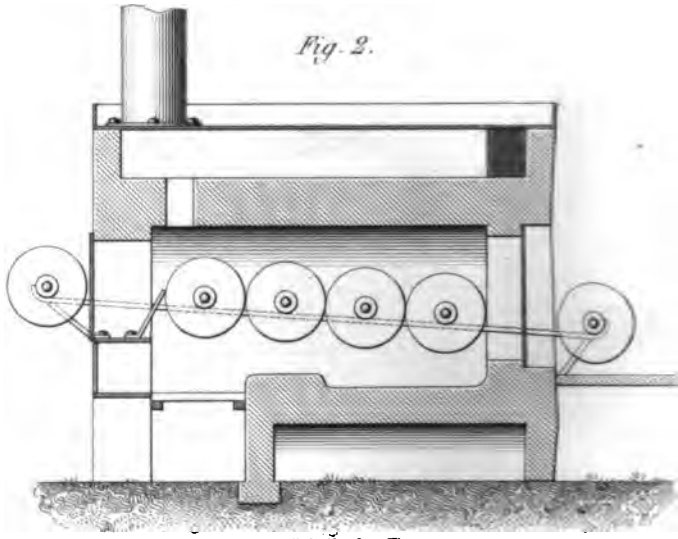
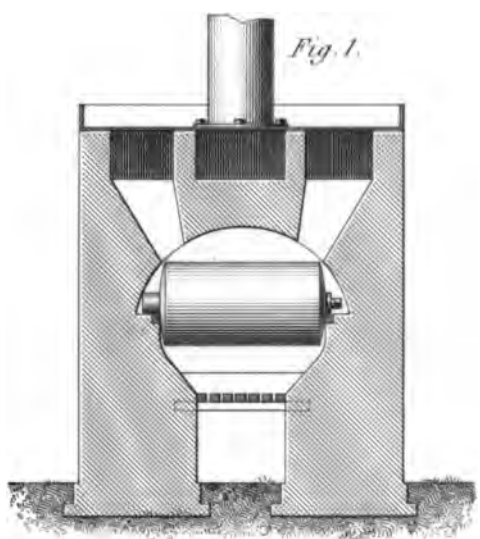


Echelle.

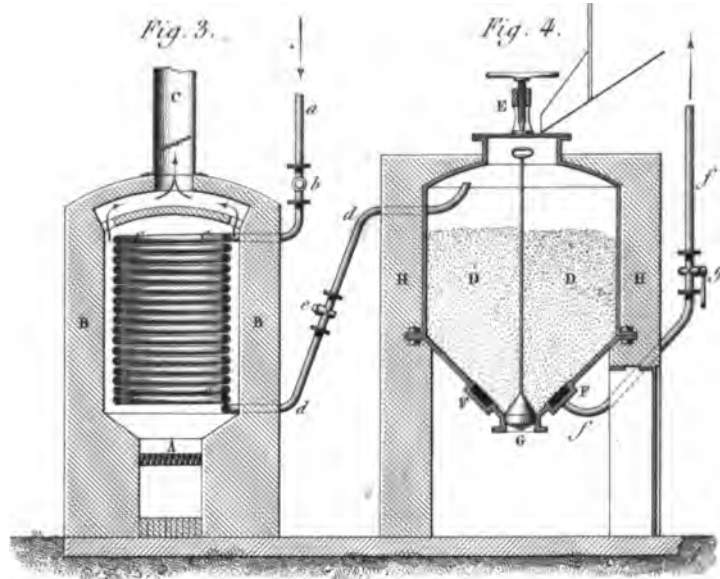
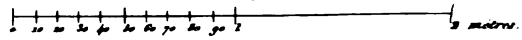








Échelle des Fig. 1 et 2.



Échelle des Fig. 3 et 4.

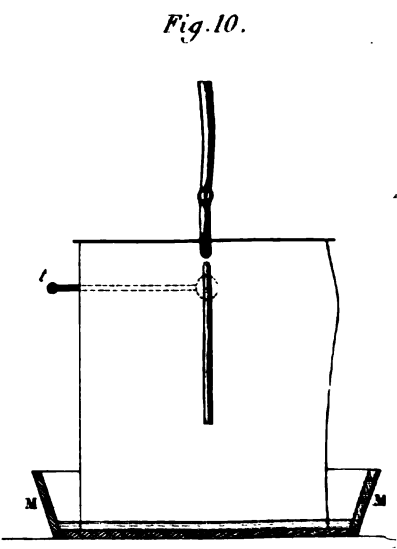


Fig. 10.

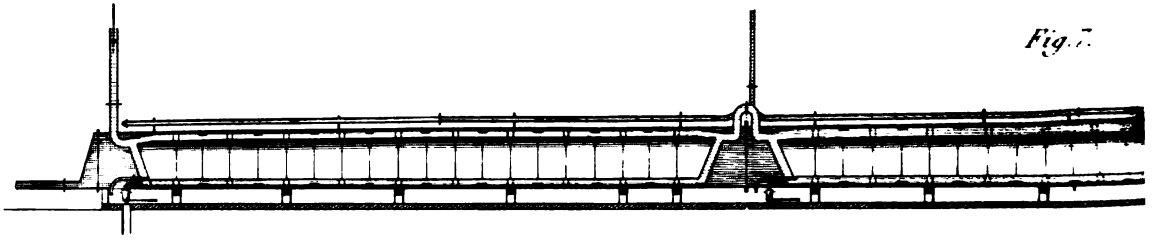


Fig. 7.

Fig. 5.

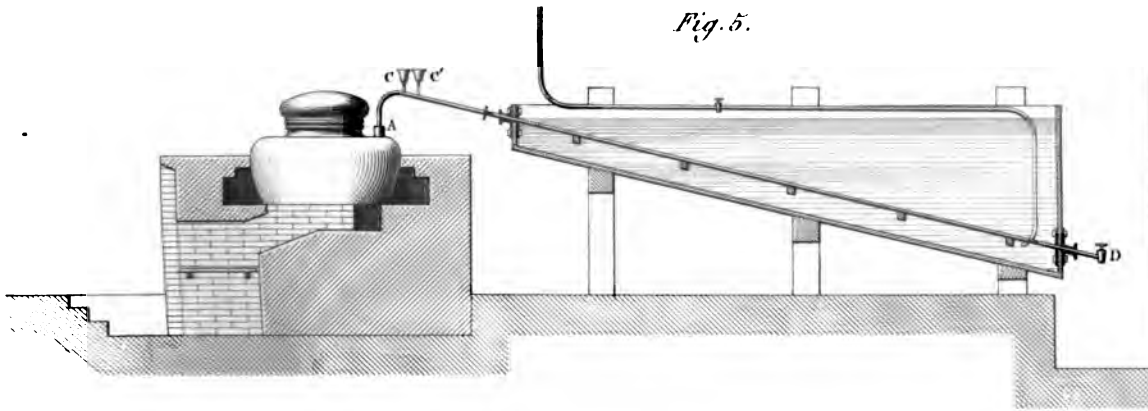


Fig. 6.

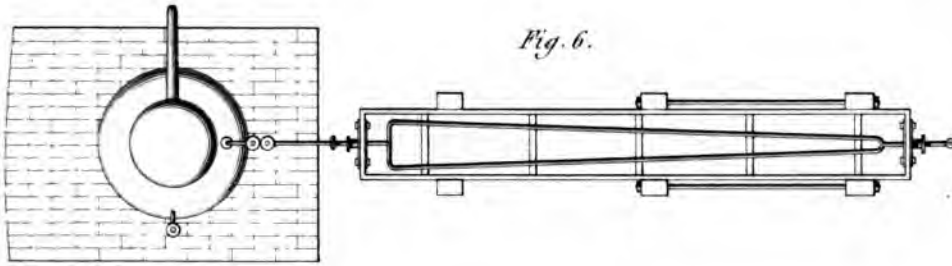


Fig. 9.

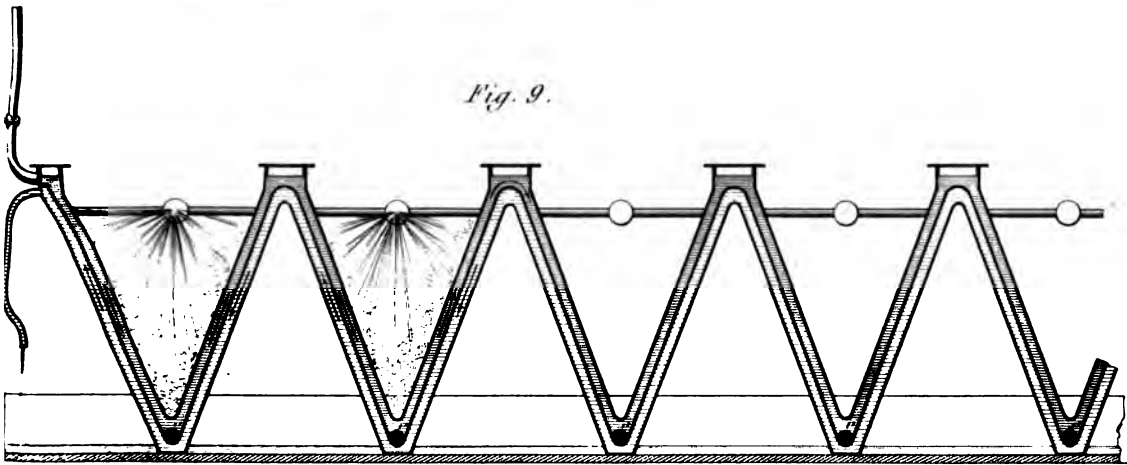
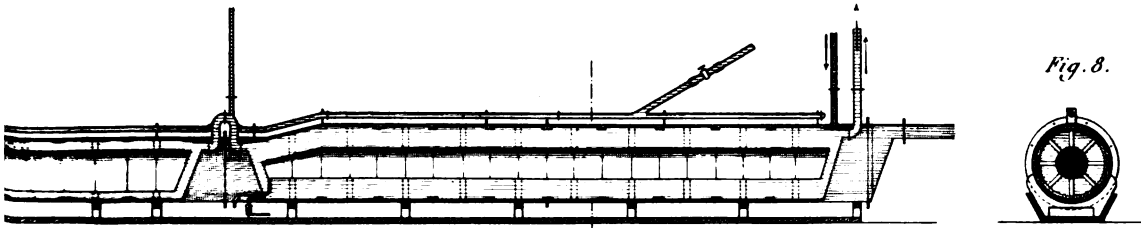
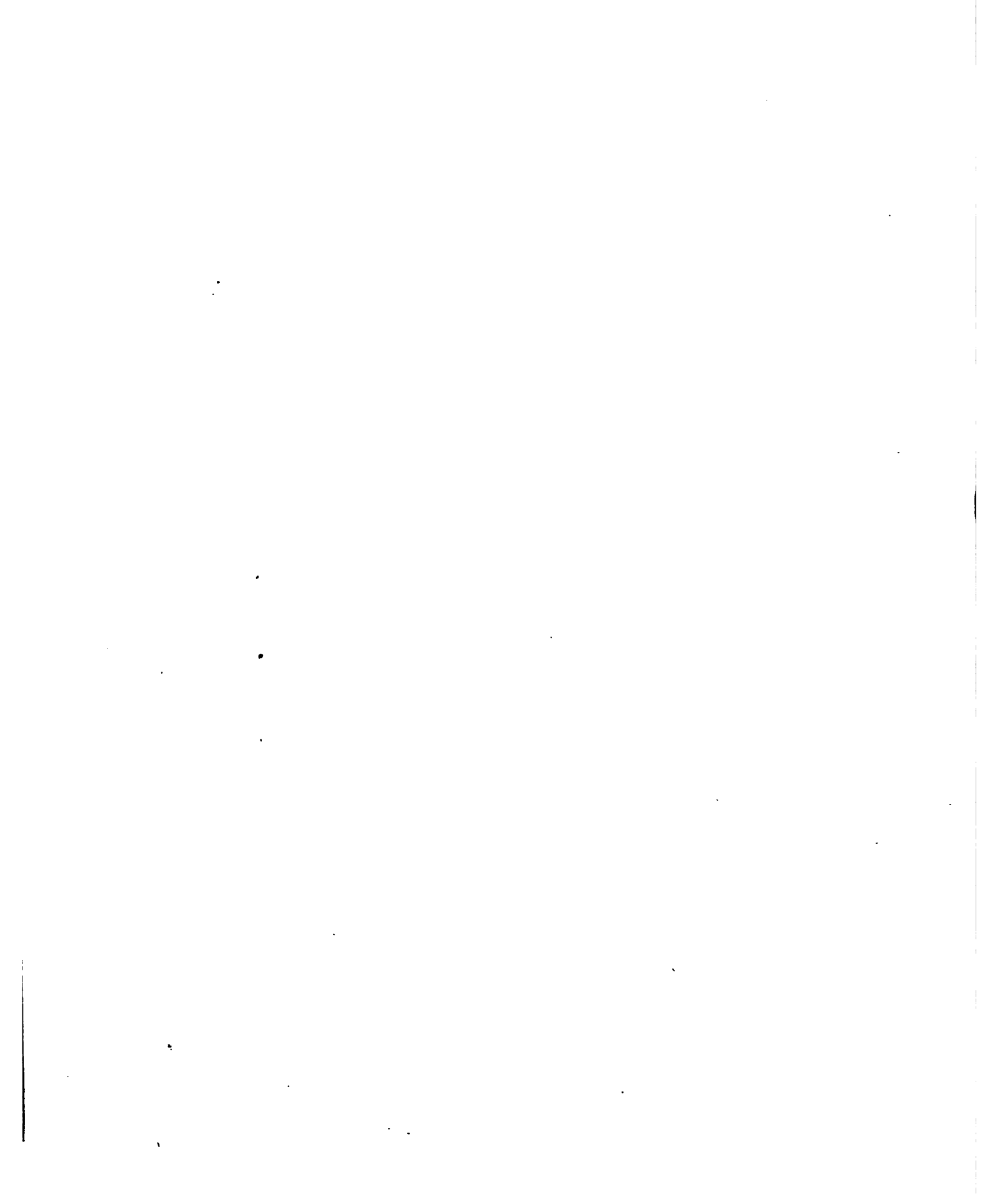


Fig. 8.







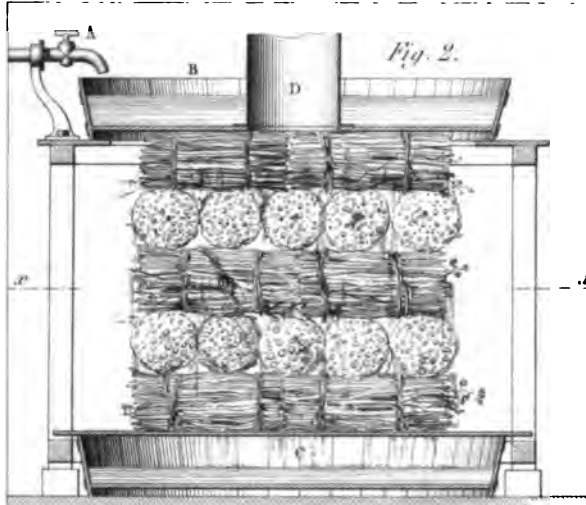


Fig. 2.

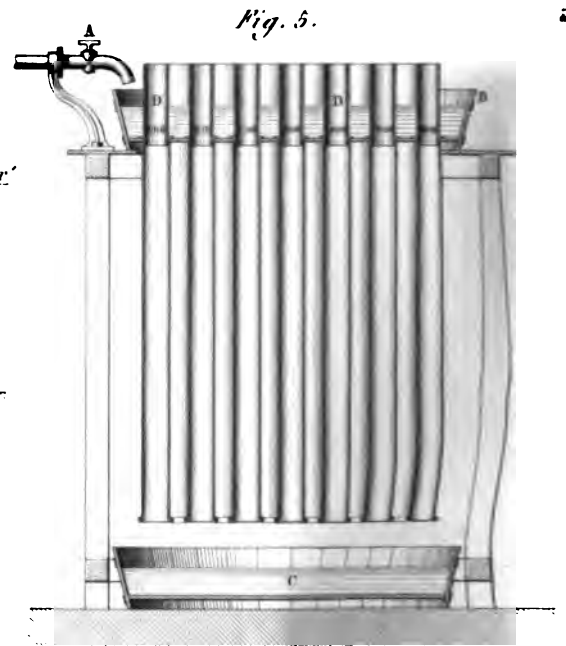


Fig. 5.

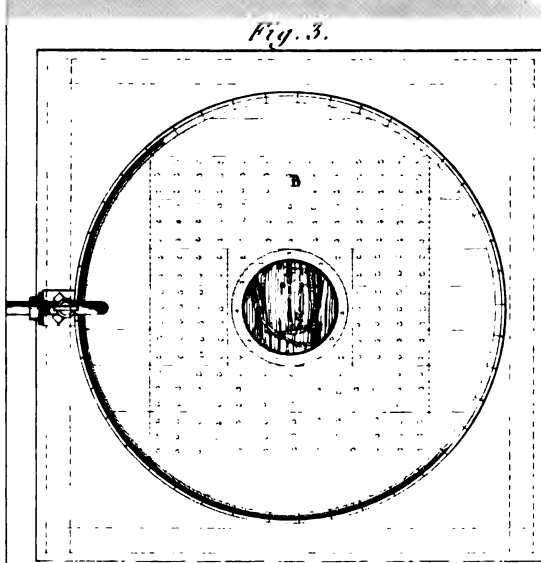


Fig. 3.

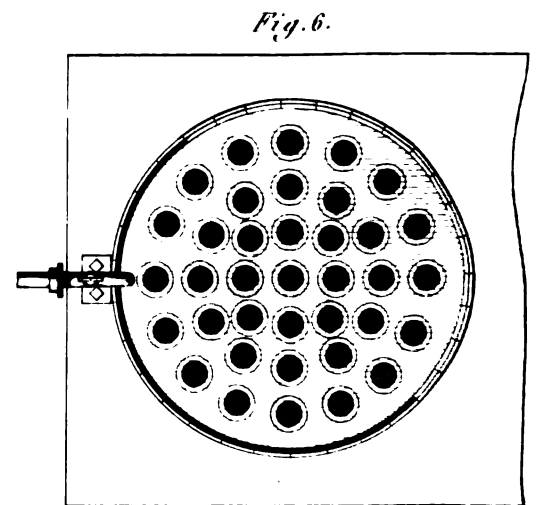


Fig. 6.

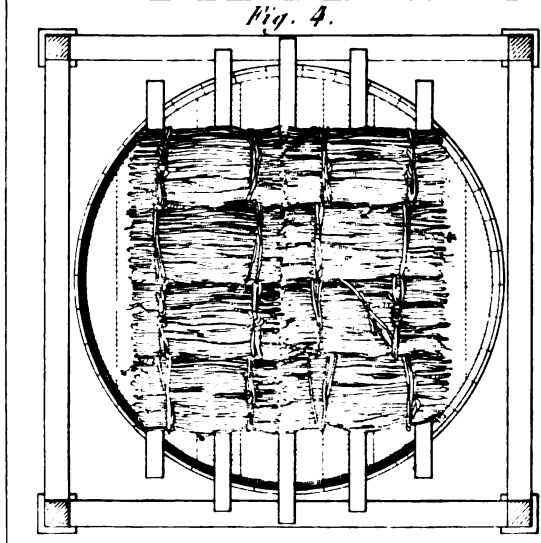


Fig. 4.

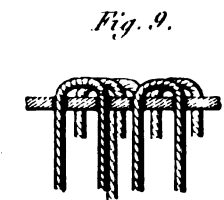


Fig. 9.

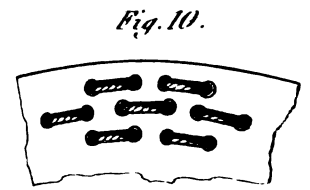
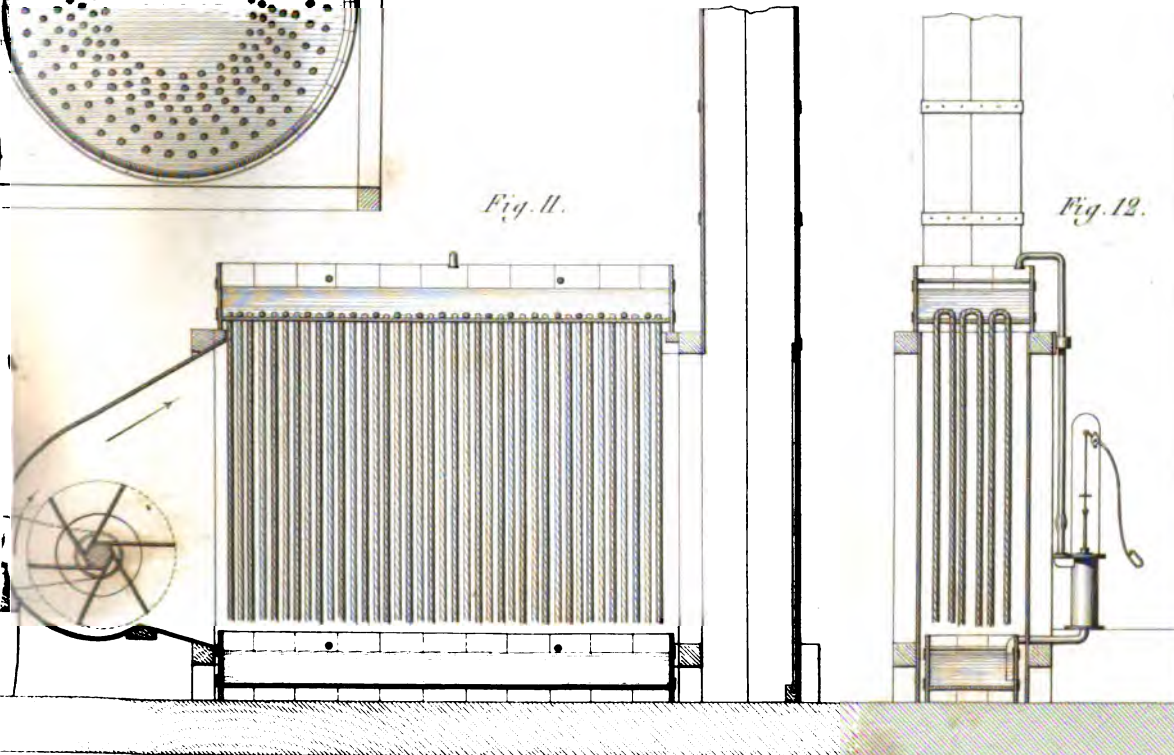
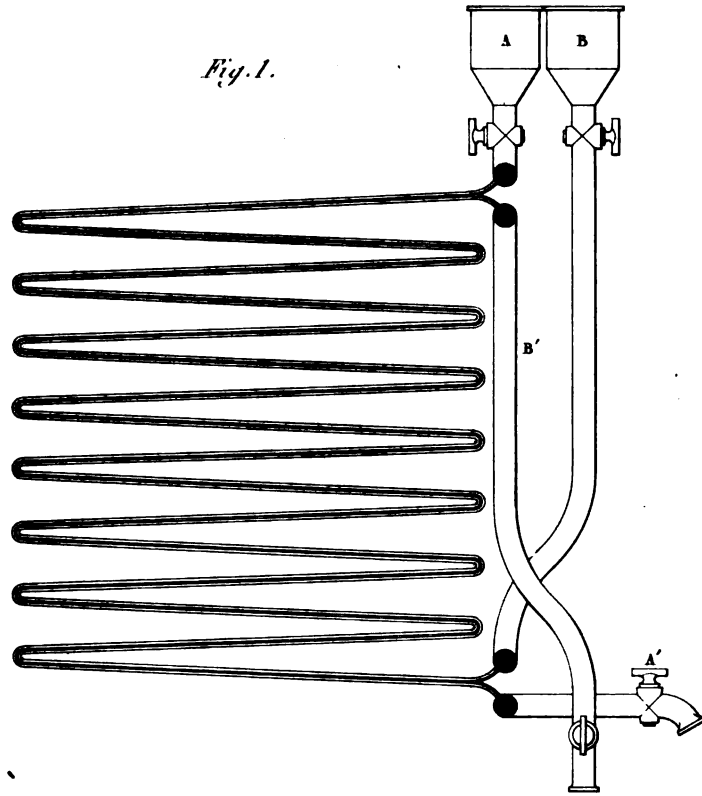
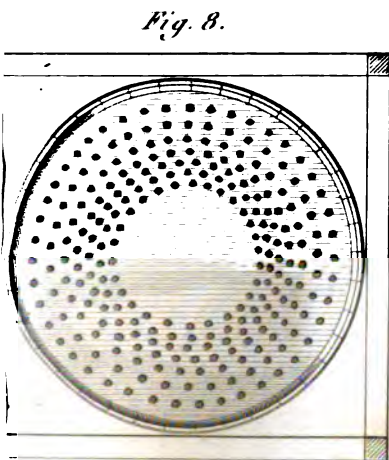
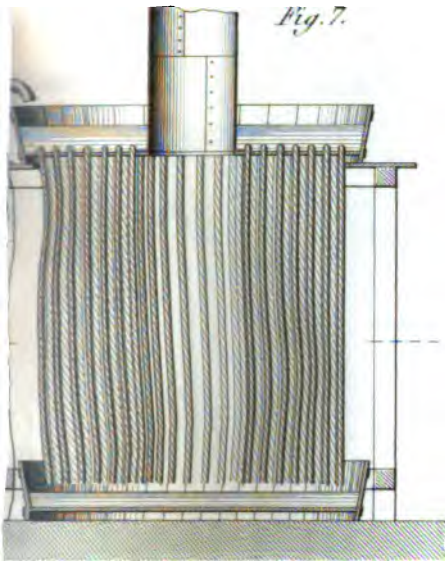
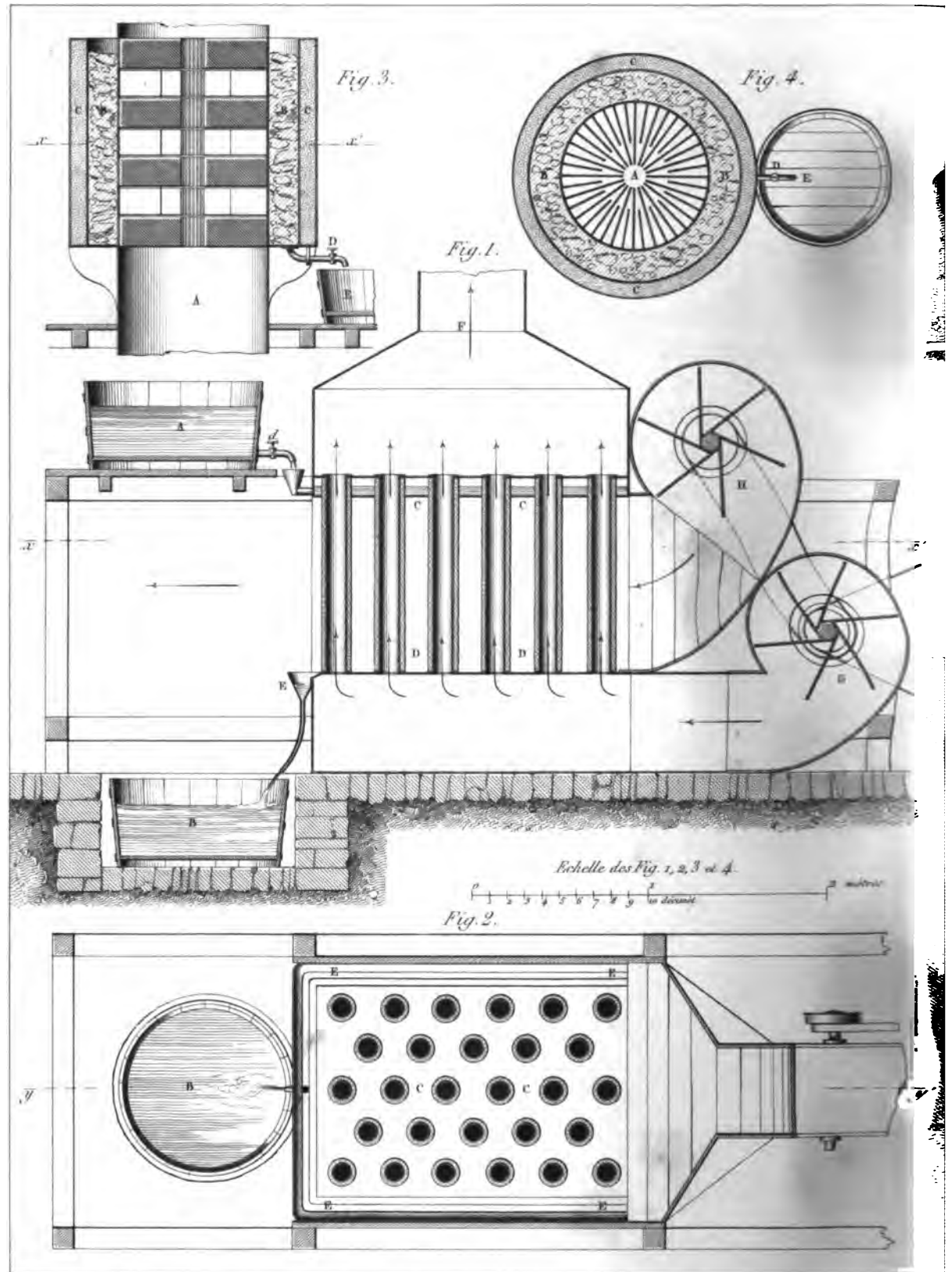
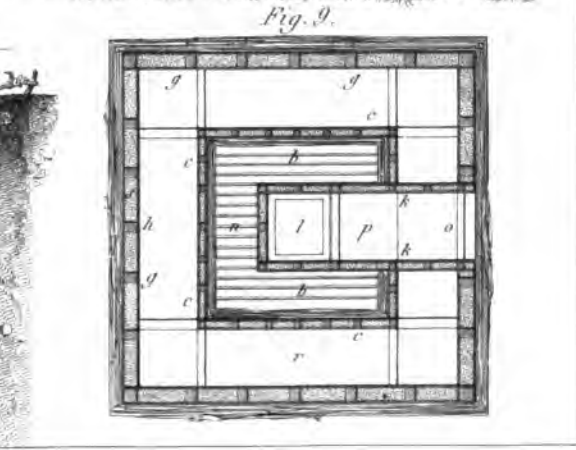
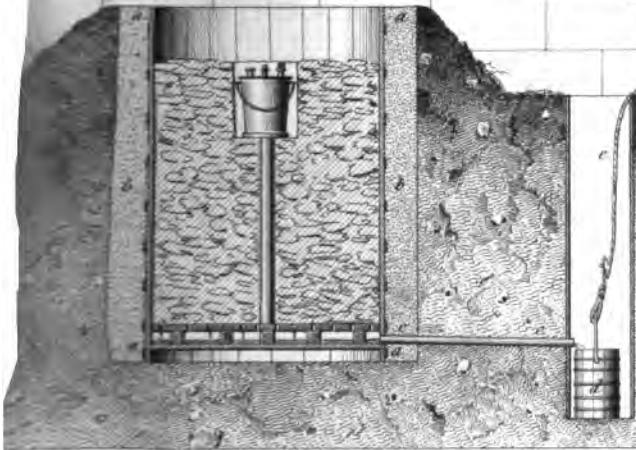
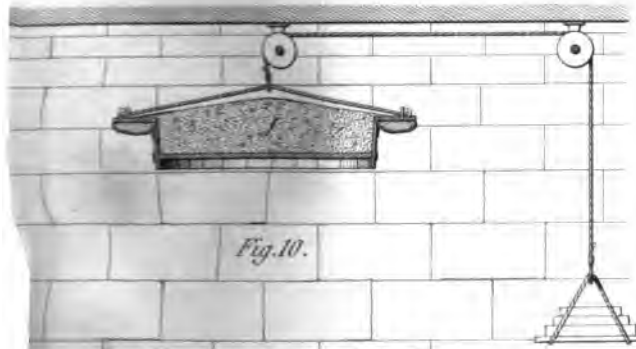
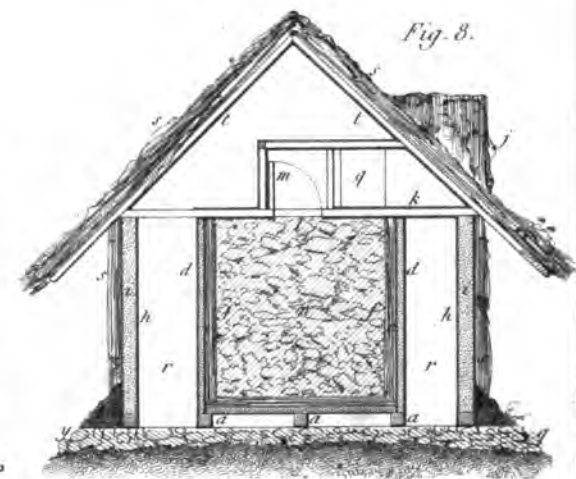
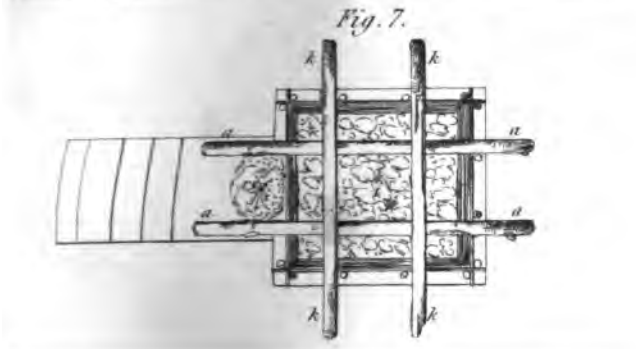
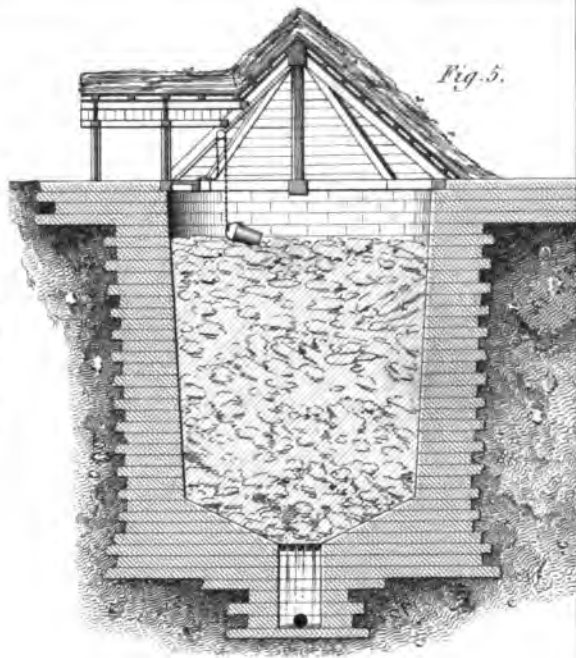
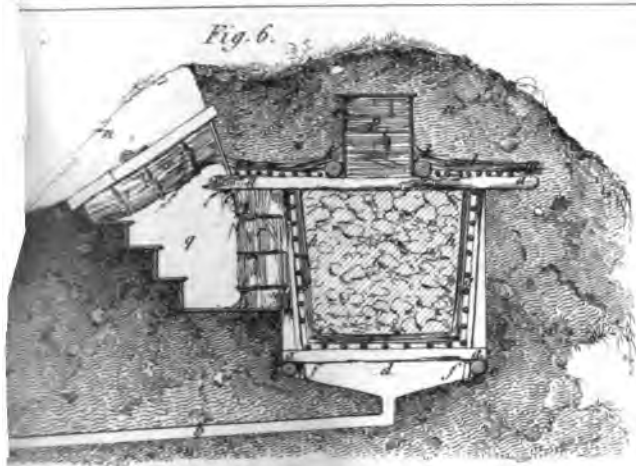


Fig. 10.









2000

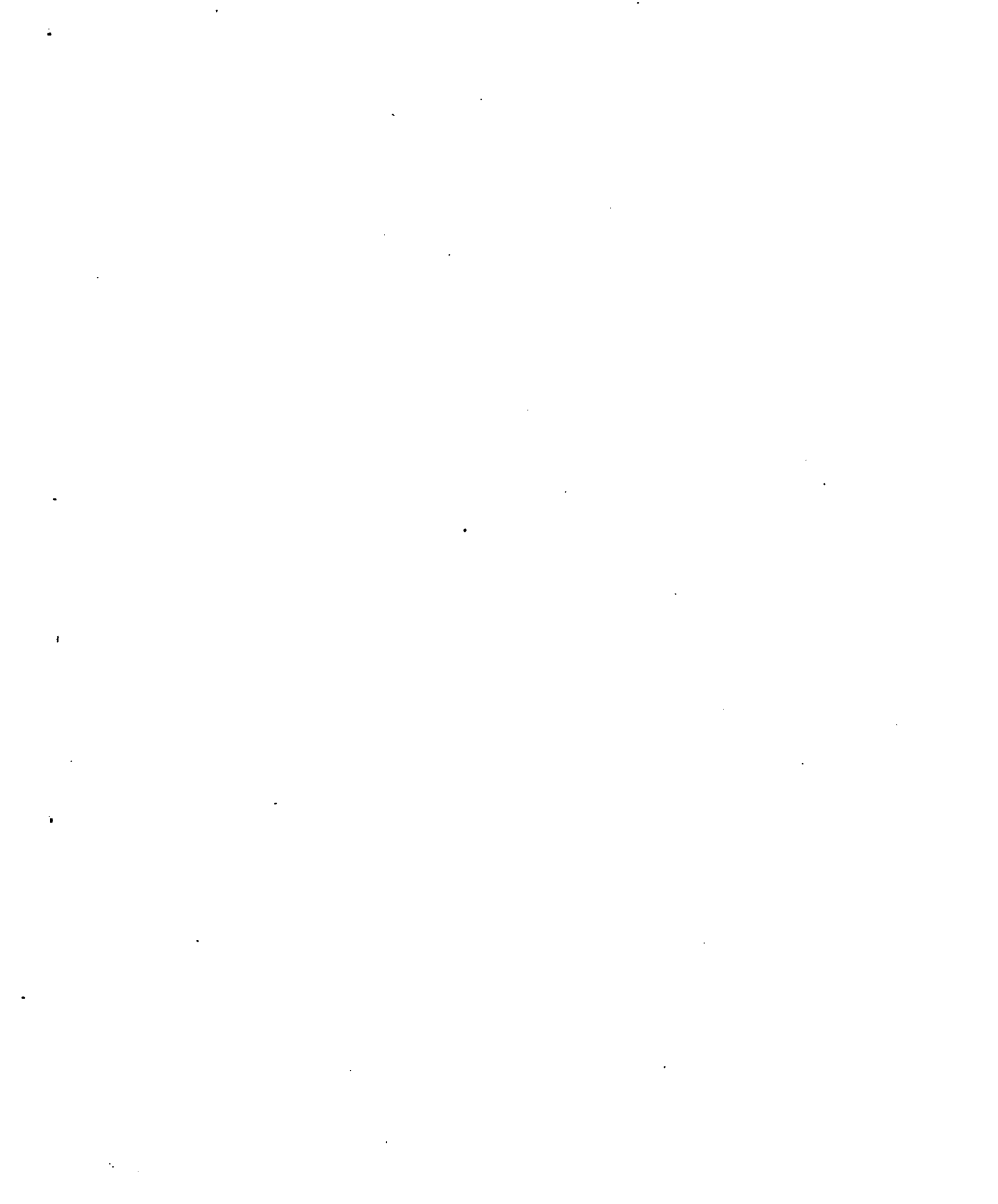


Fig. 10.

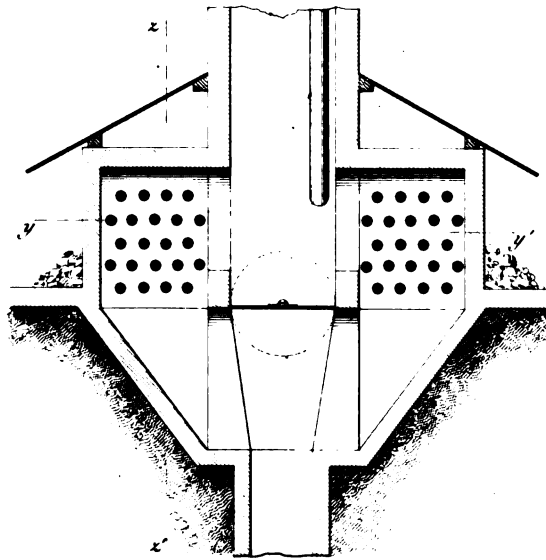


Fig. 11.

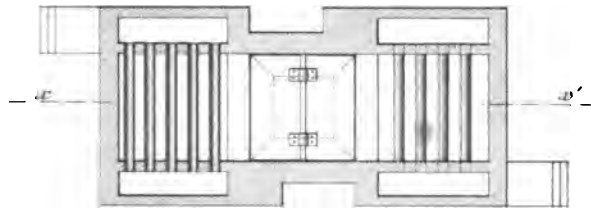


Fig. 12.

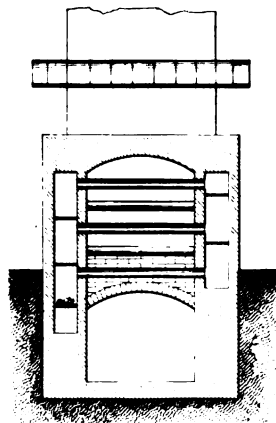


Fig. 1.

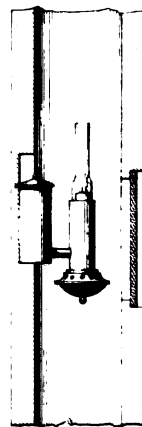


Fig. 2.

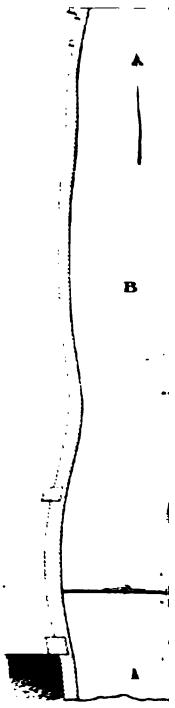
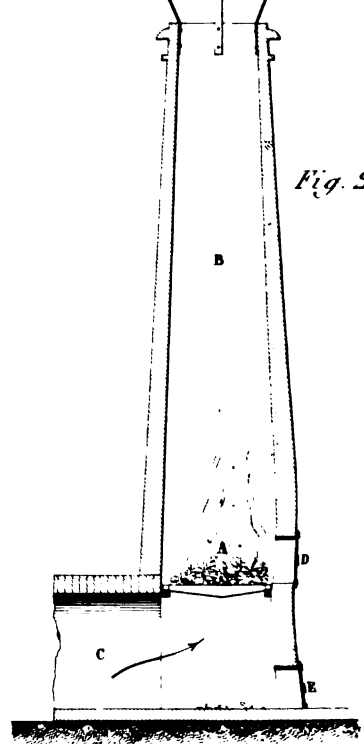
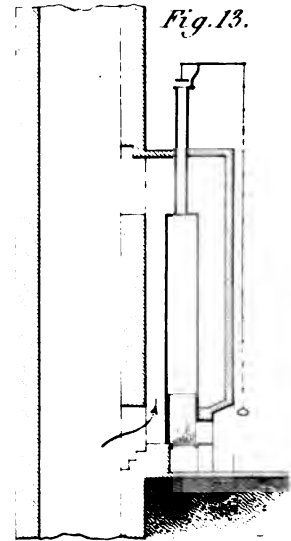
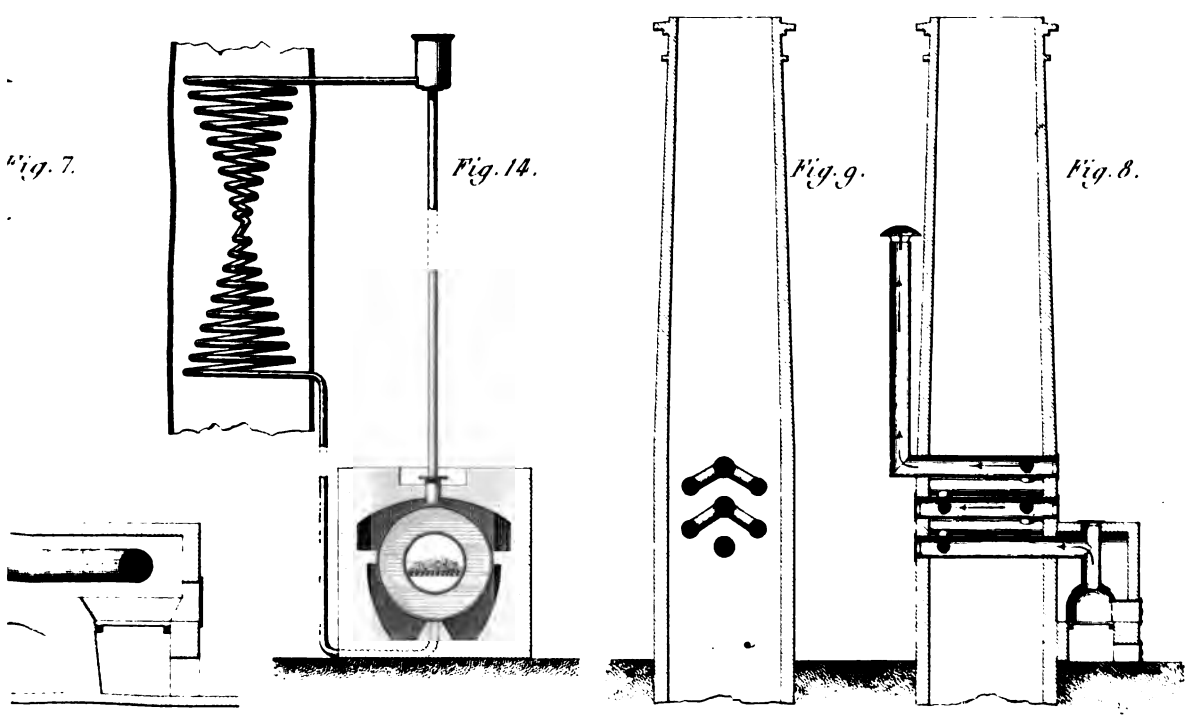
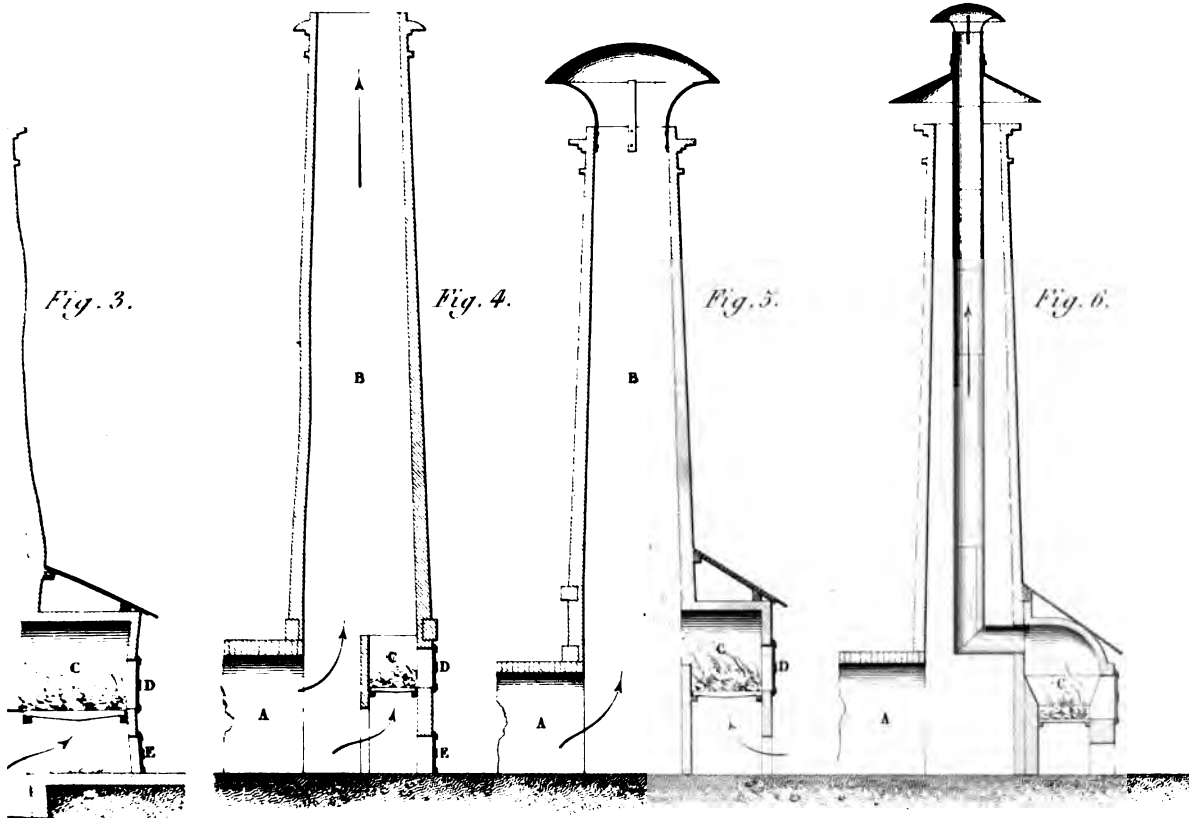
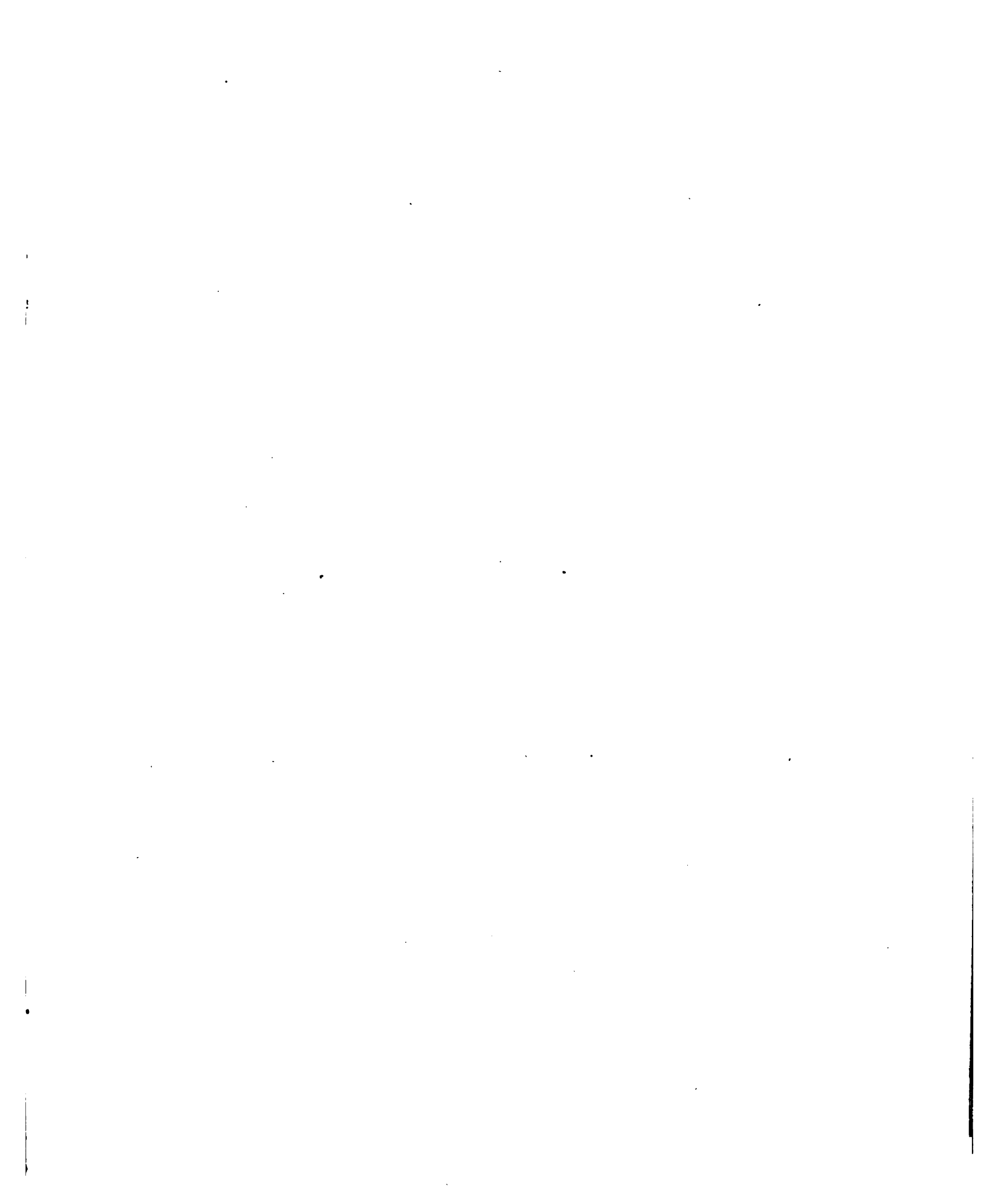


Fig. 13.









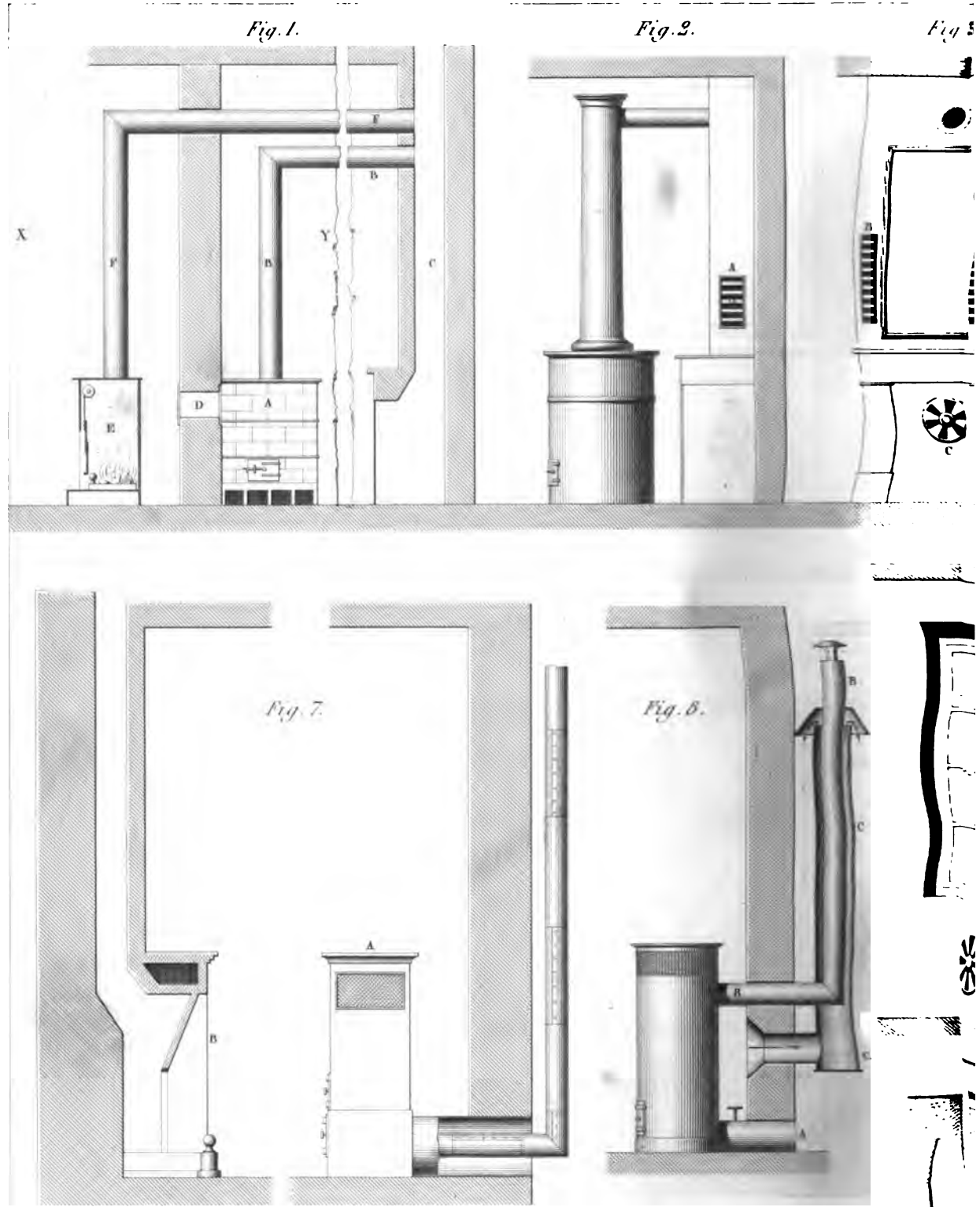


Fig. 4.

Fig. 5.

Fig. 6.

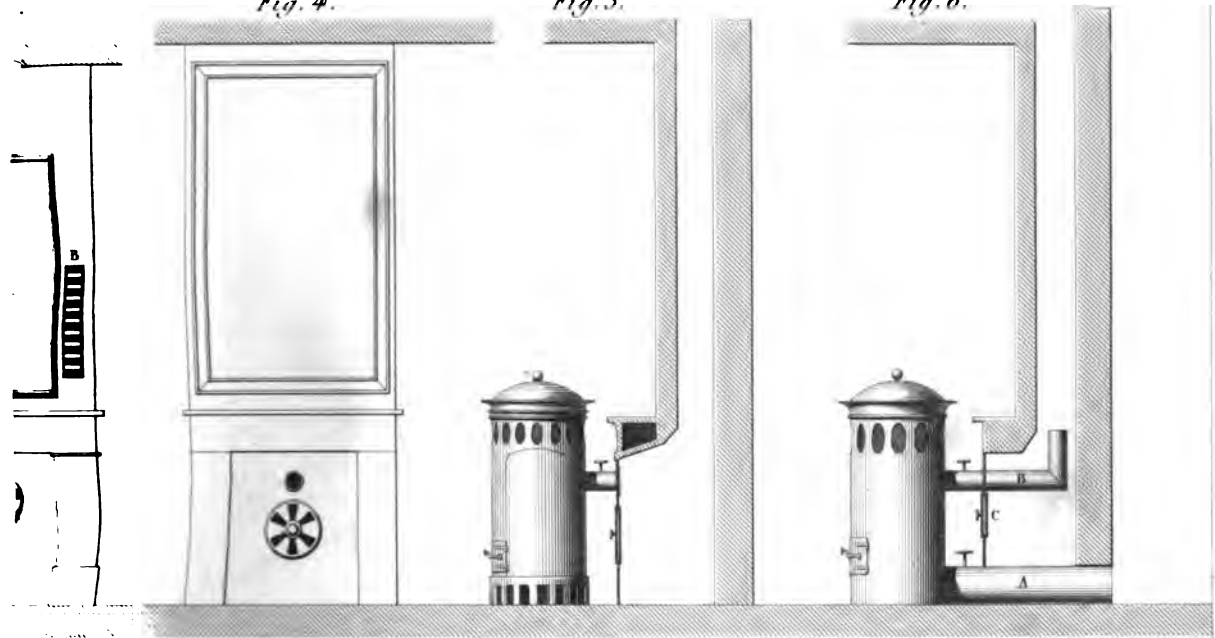


Fig. 9.

Fig. 11.

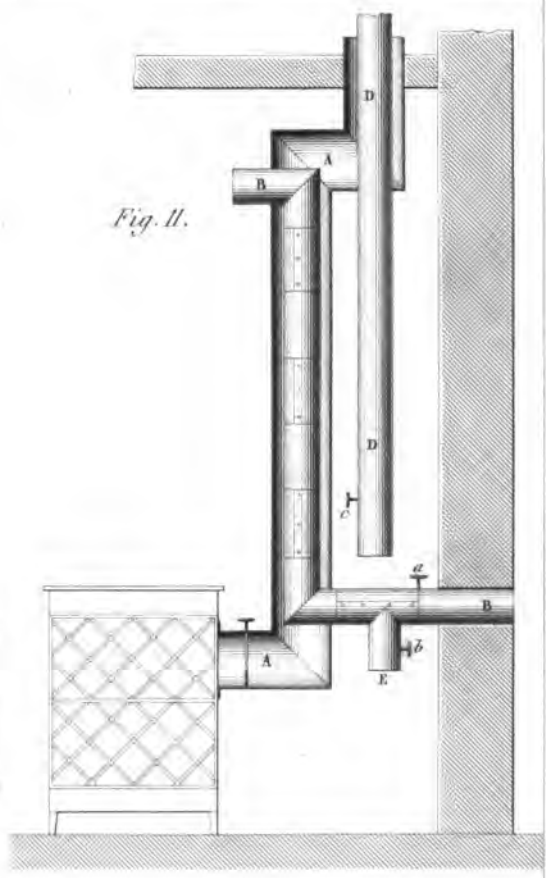
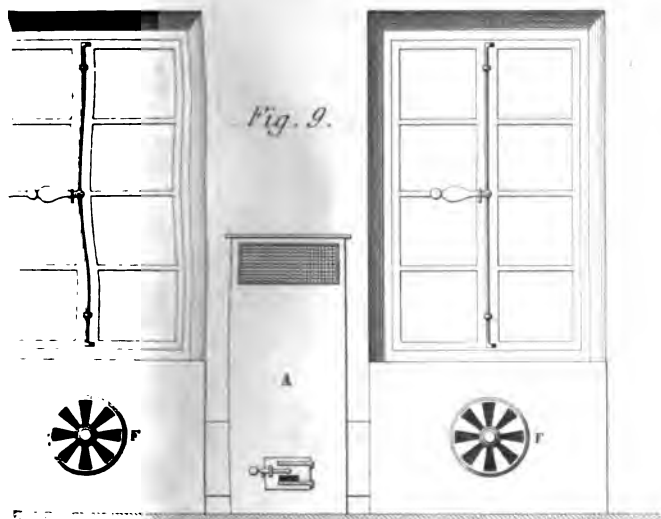
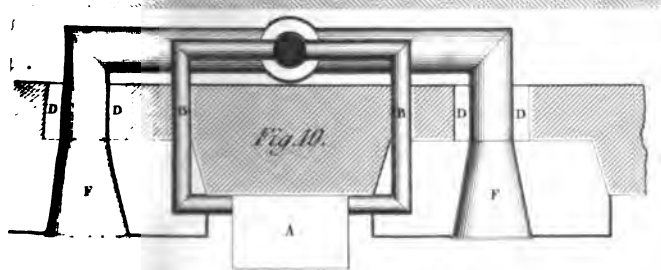
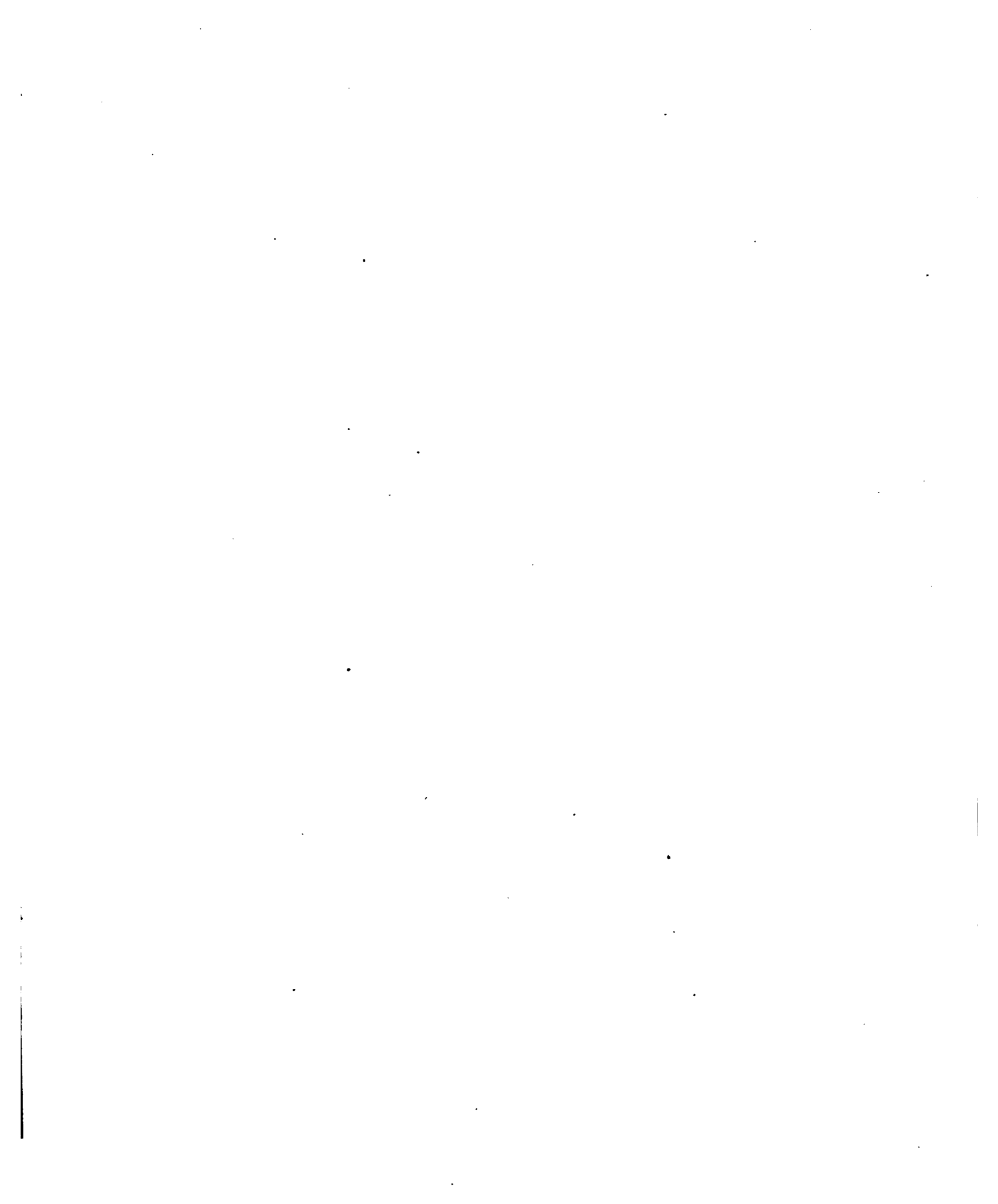
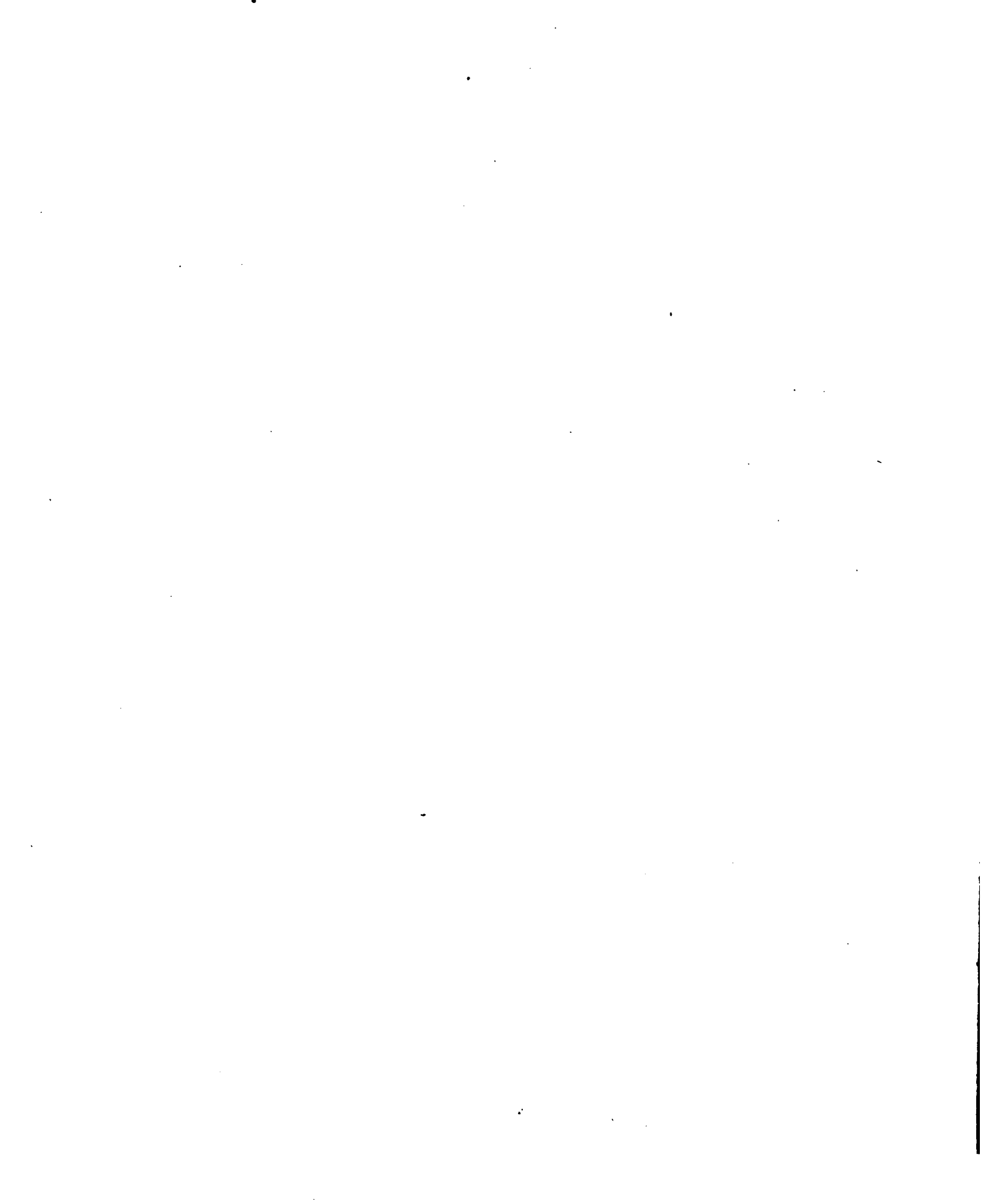


Fig. 10.







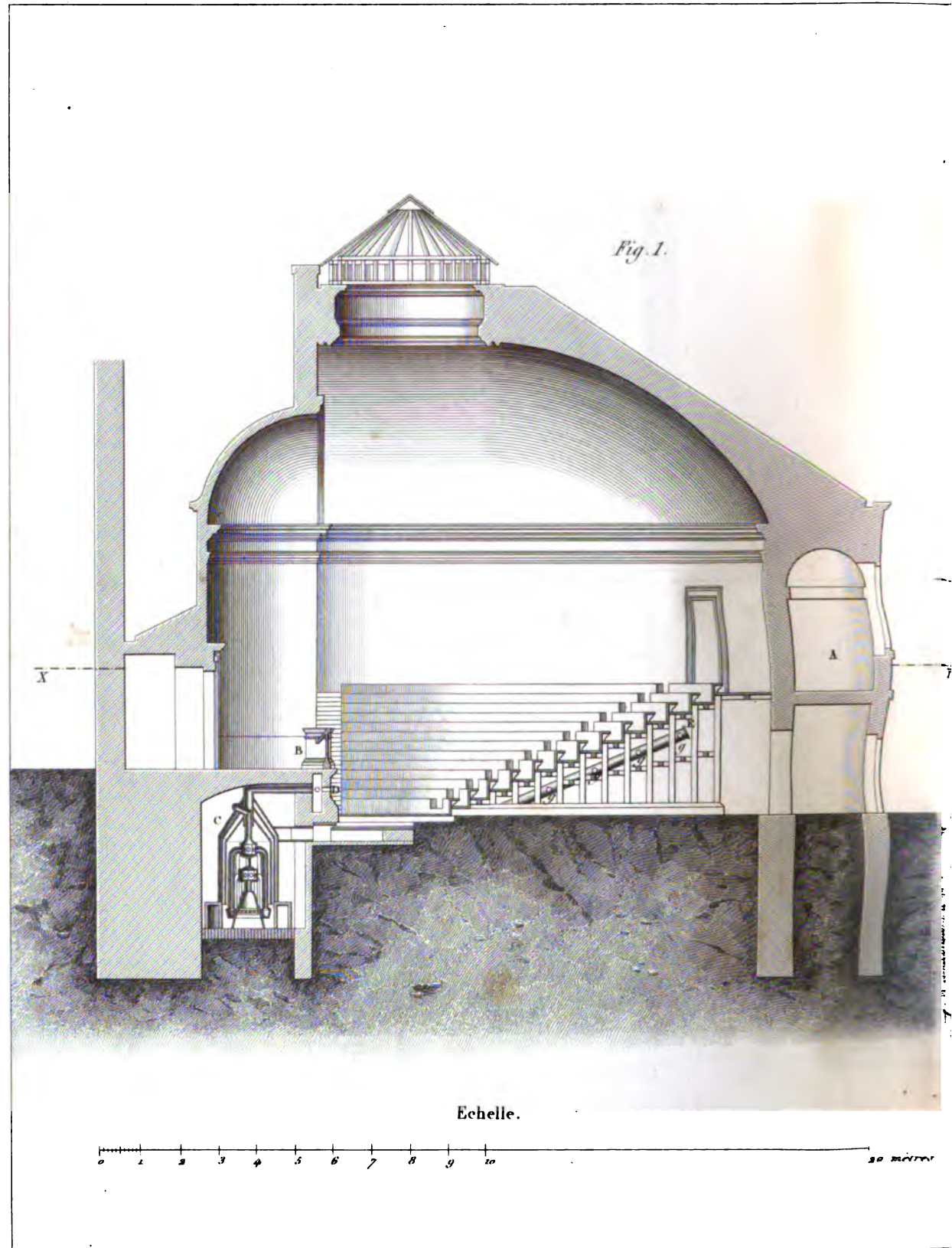


Fig. 3.

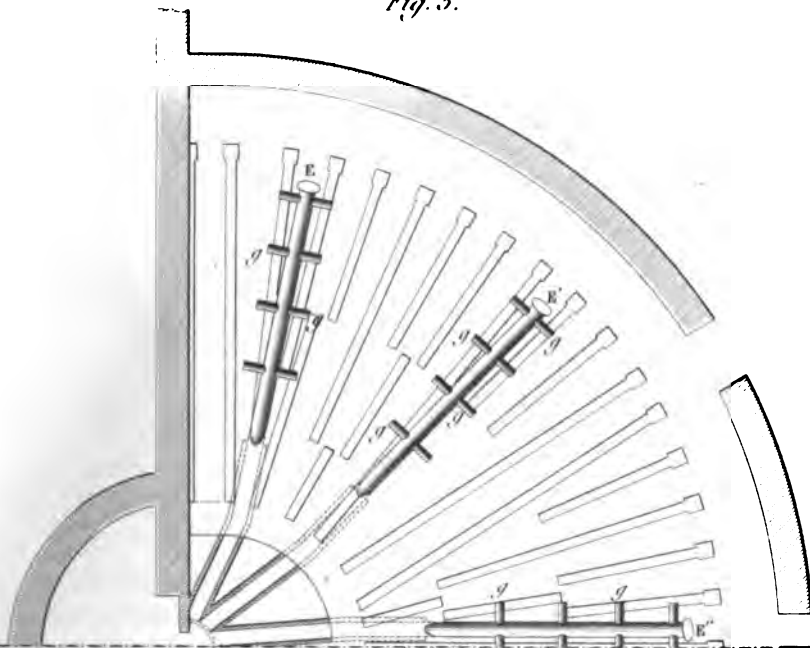
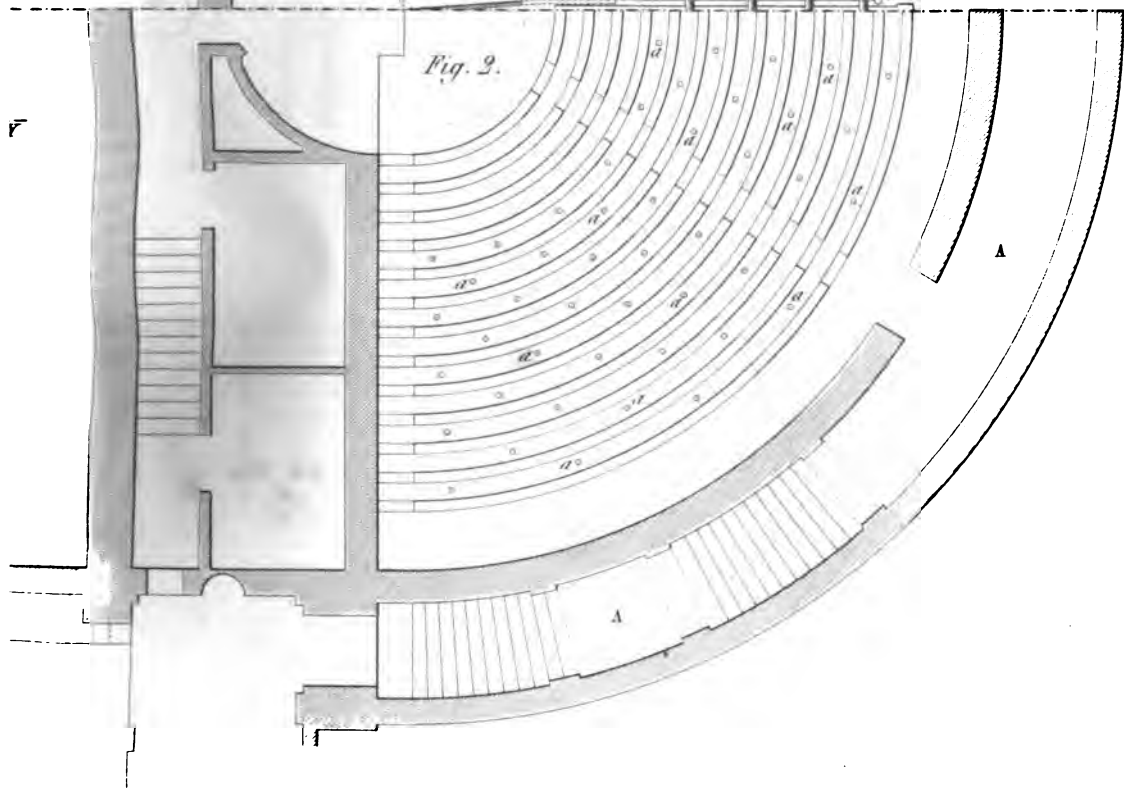
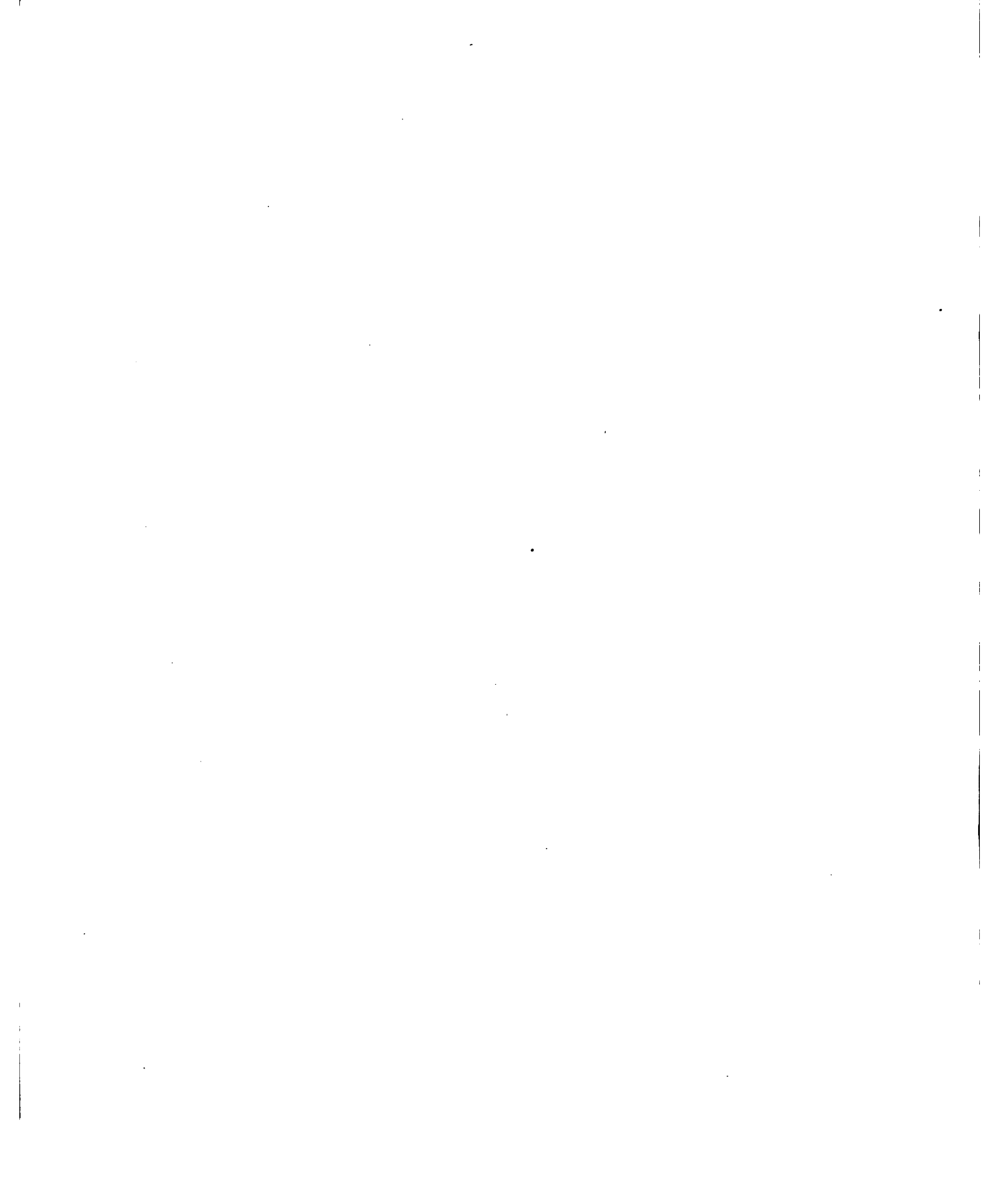
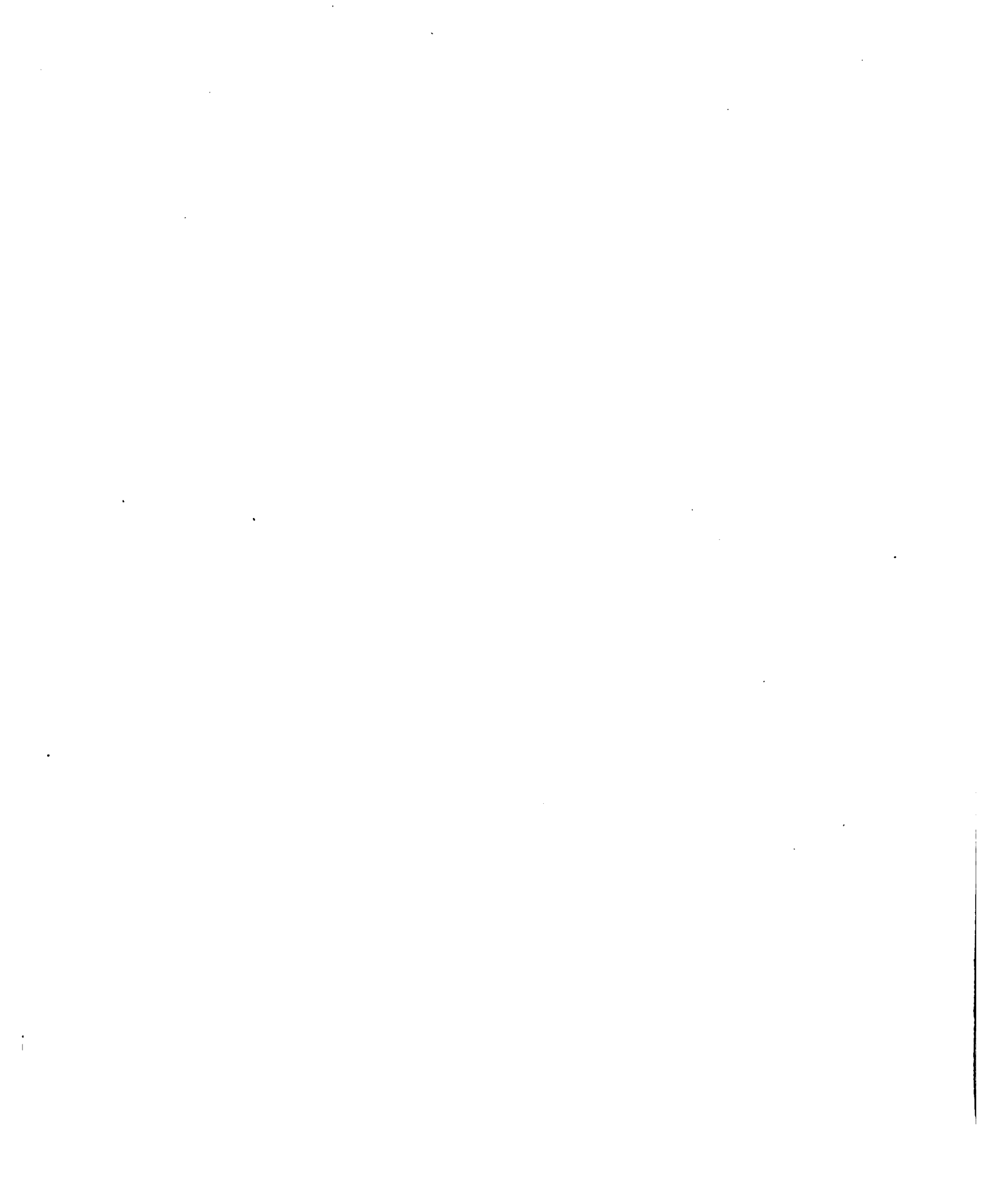


Fig. 2.







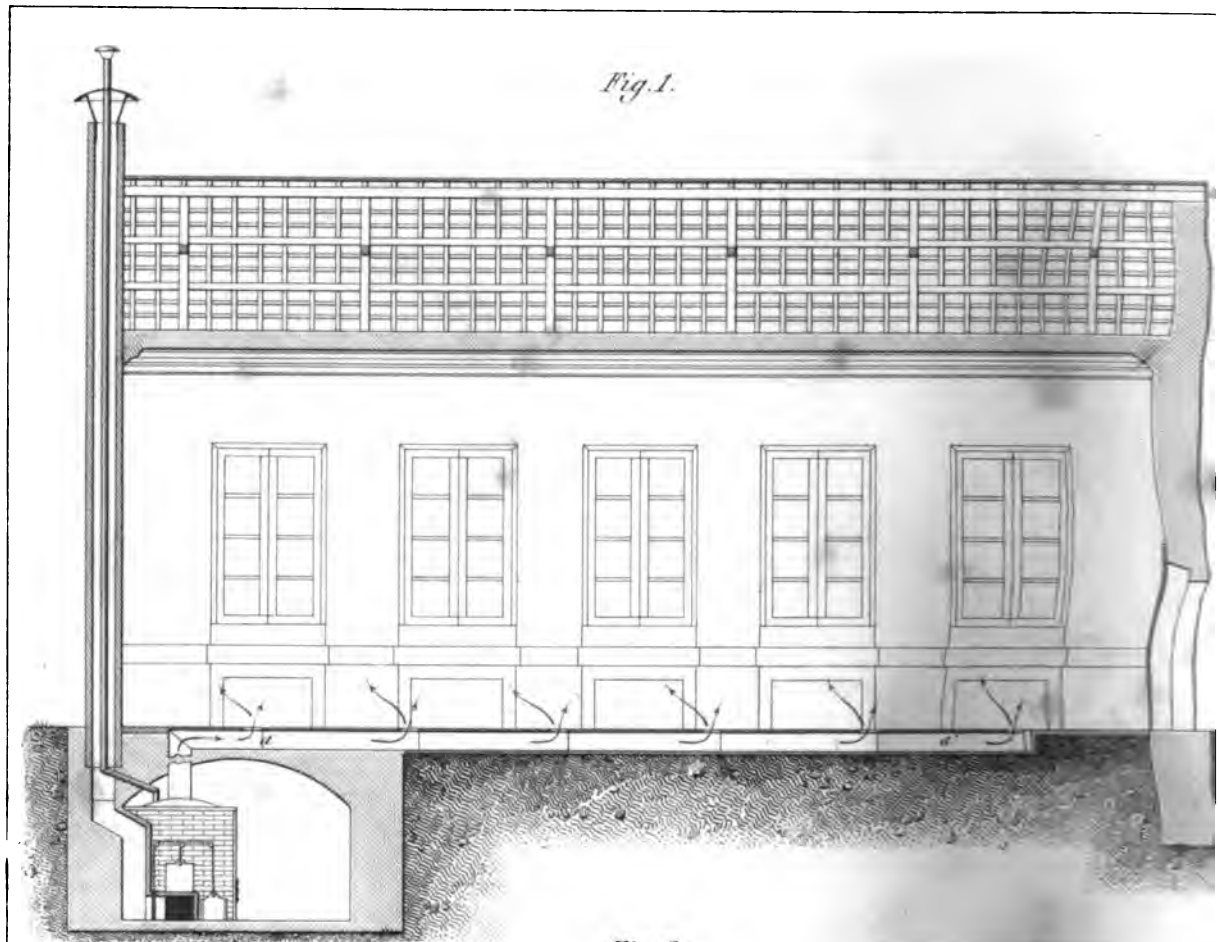


Fig. 1.

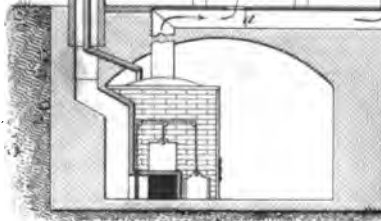
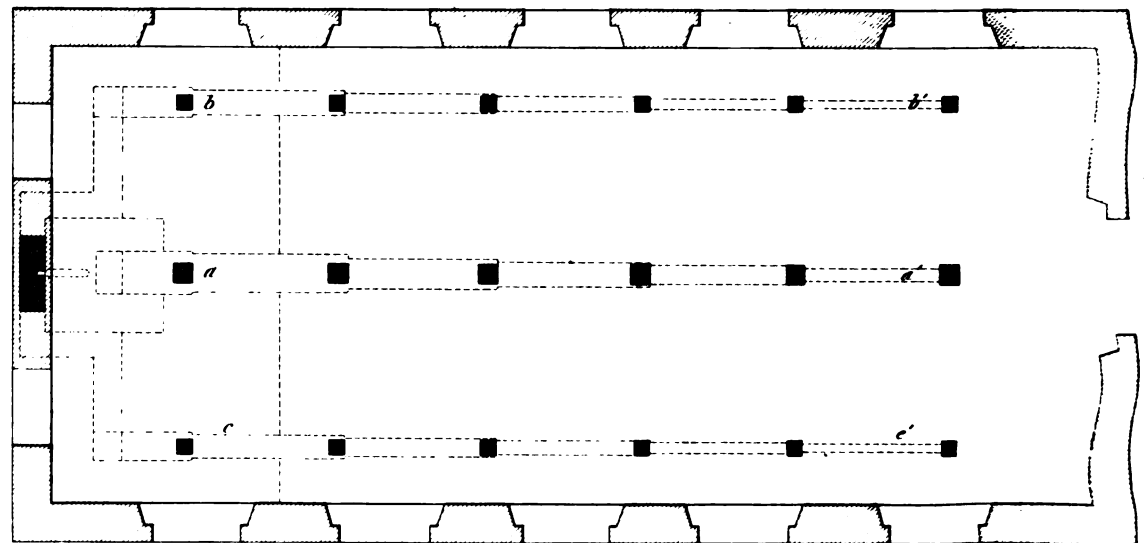


Fig. 2.



Echelle des Fig. 1 et 2.

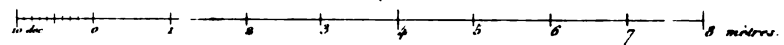


Fig. 4.

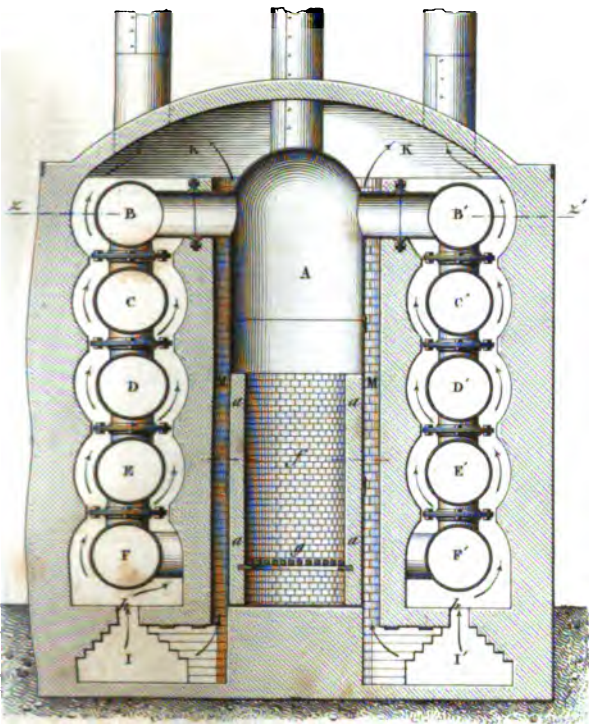


Fig. 5.

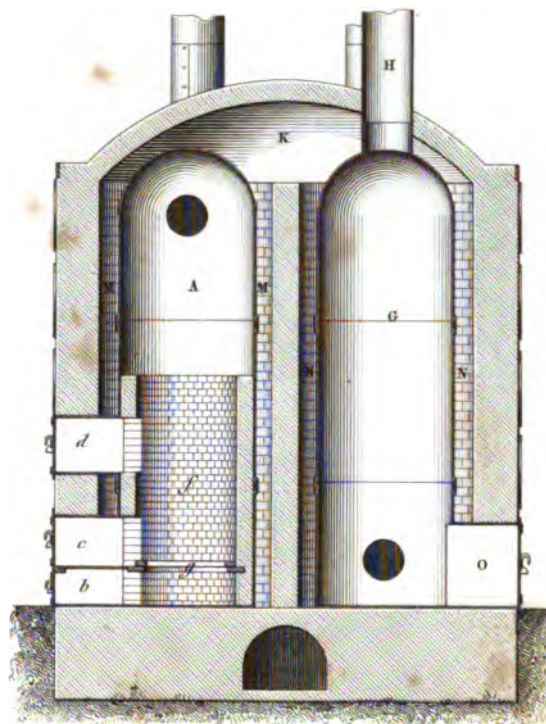
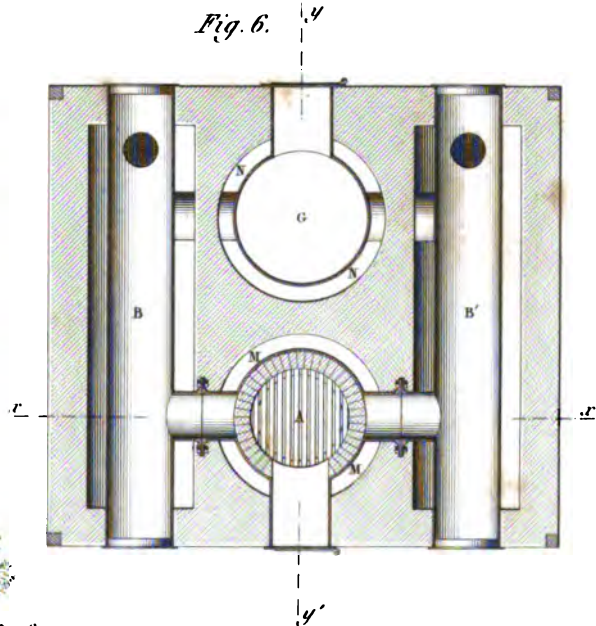


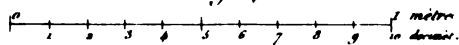
Fig. 3.

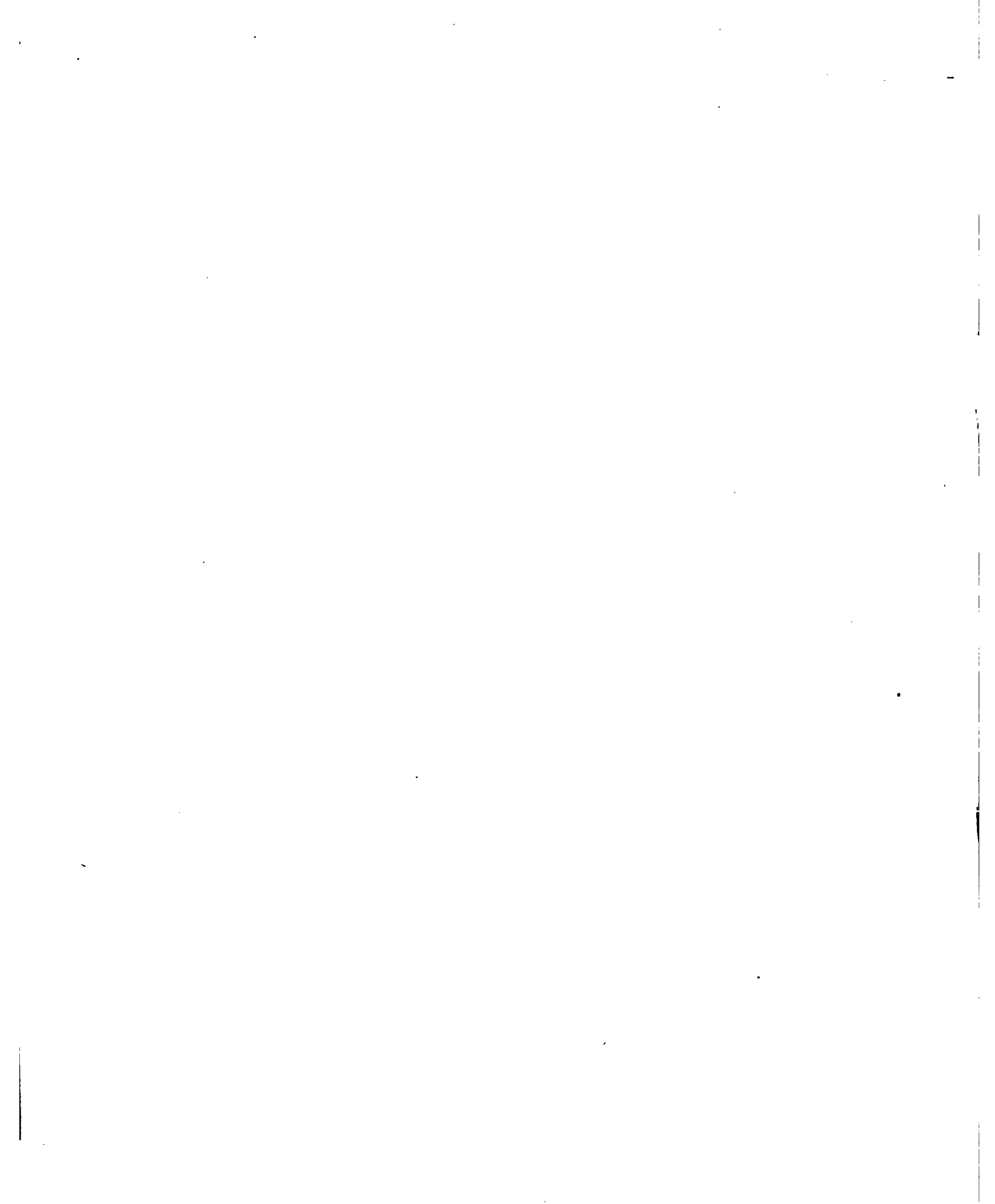


Fig. 6.

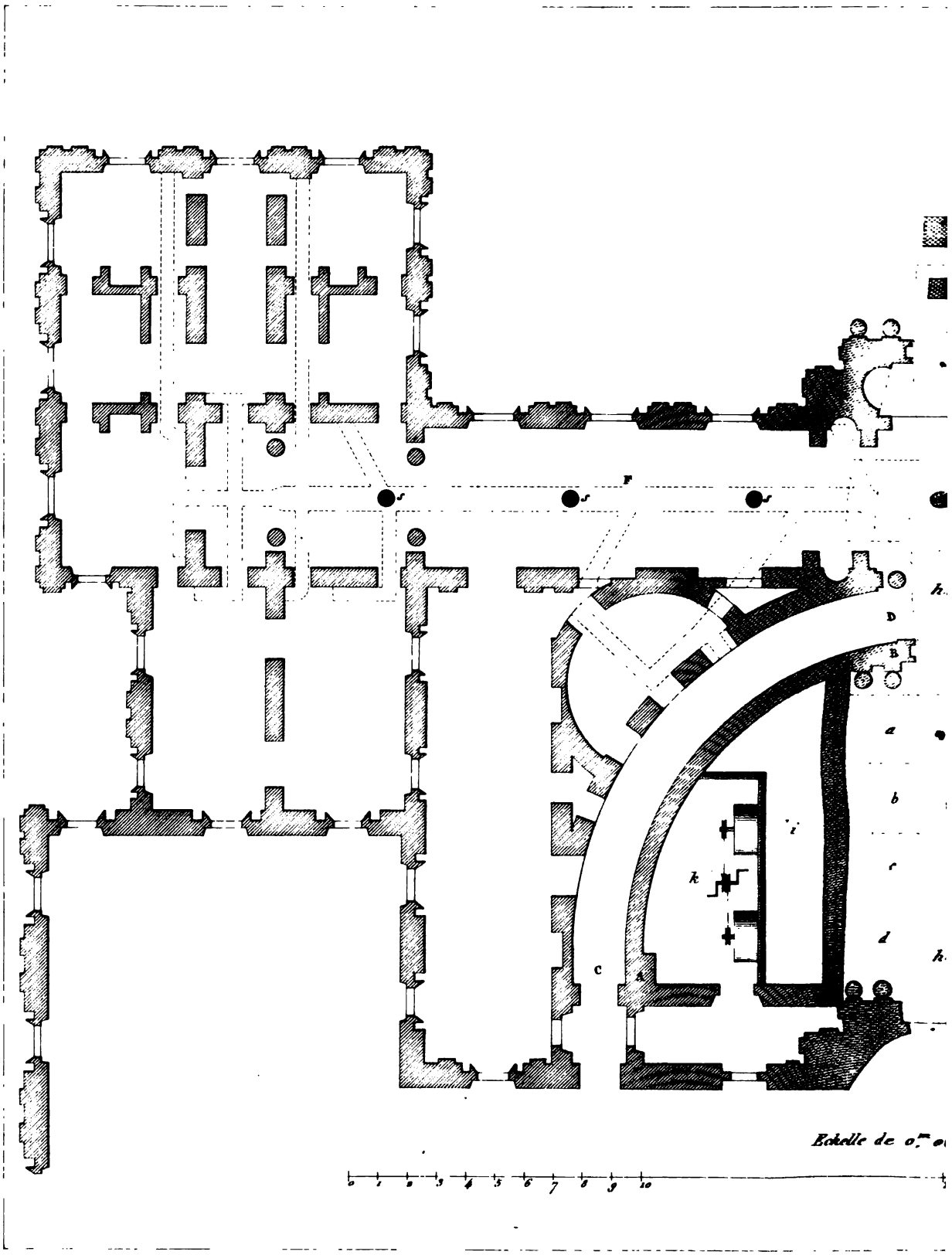


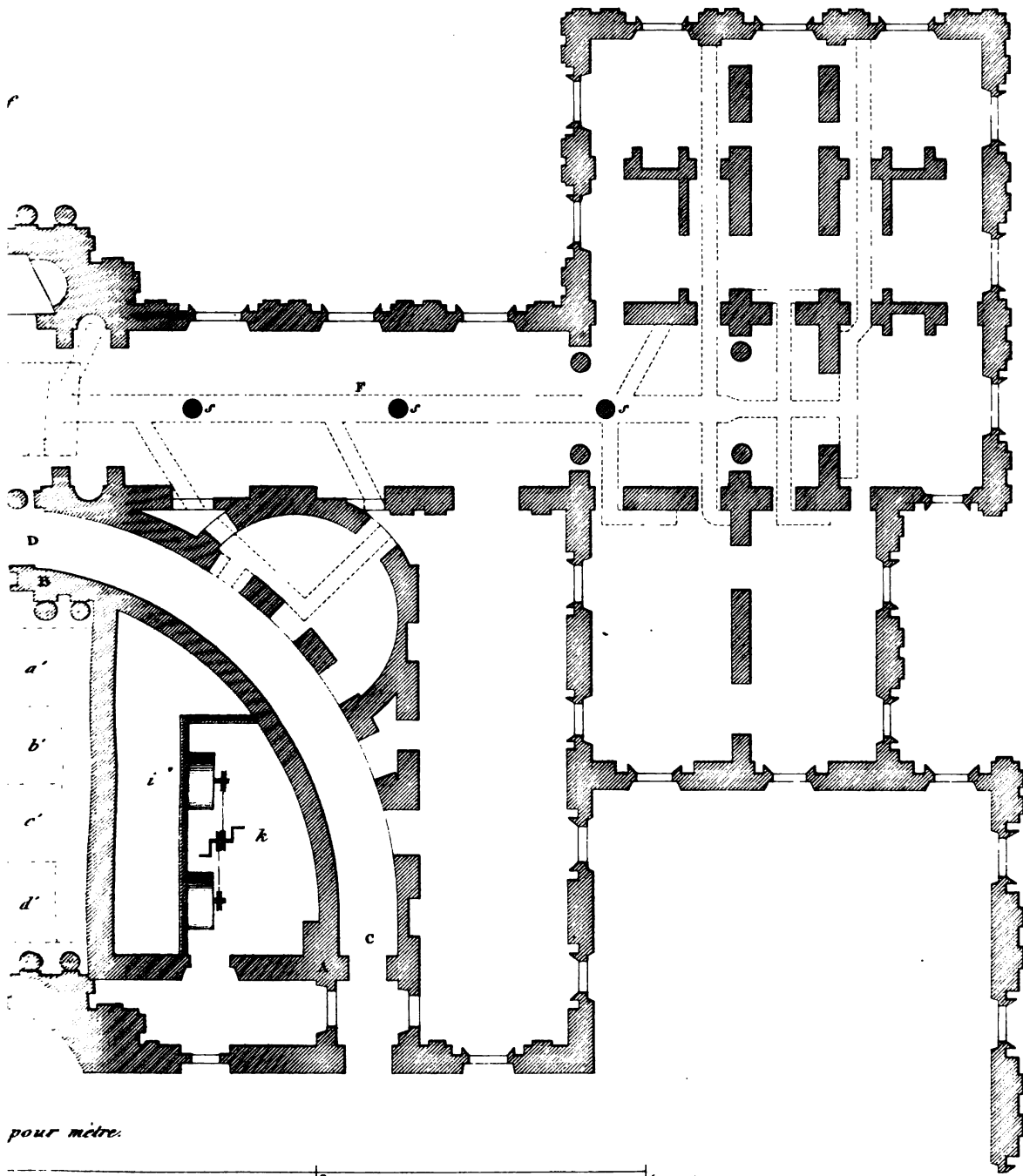
Echelle des Fig 3 & 5 et 6.



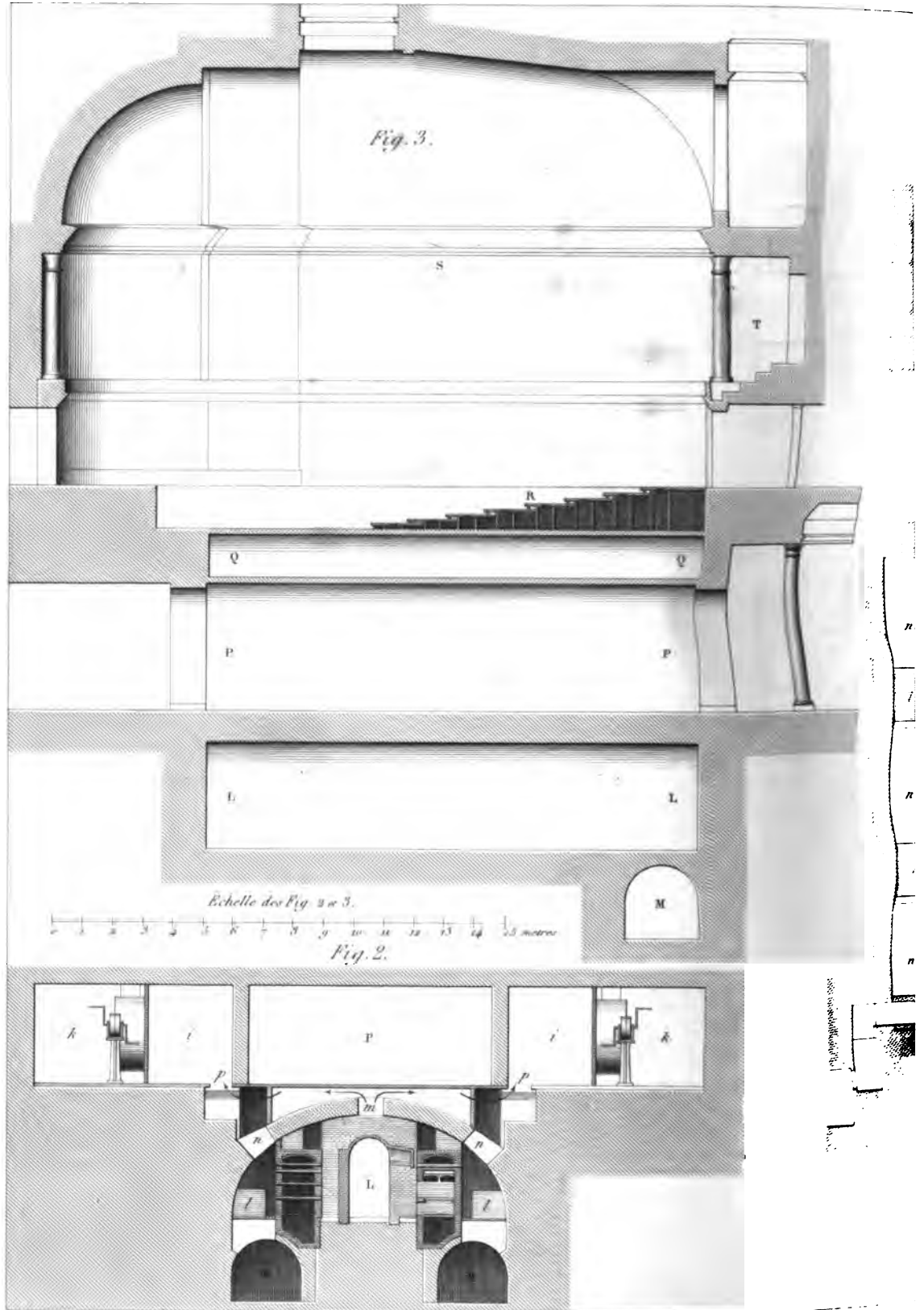


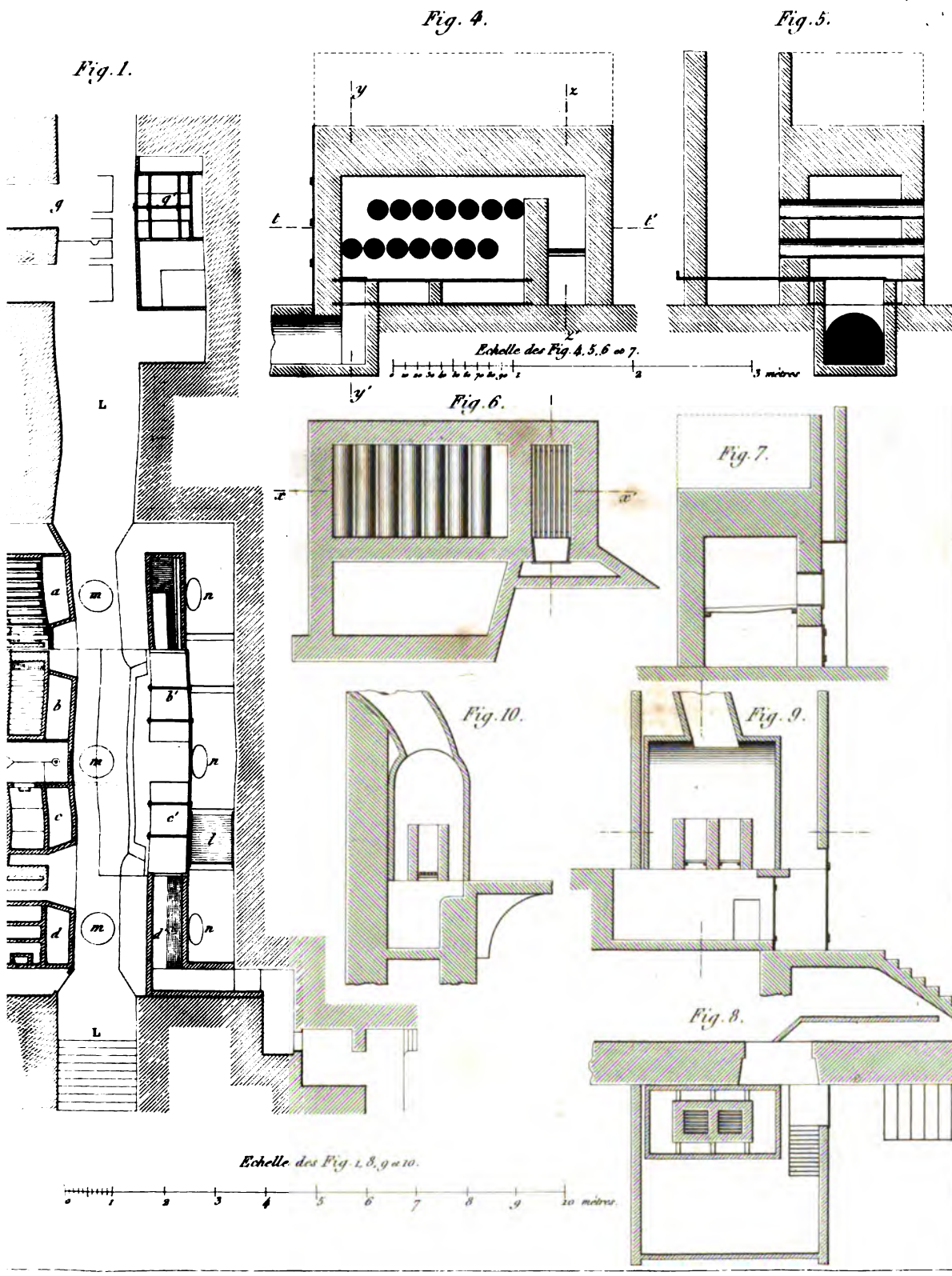




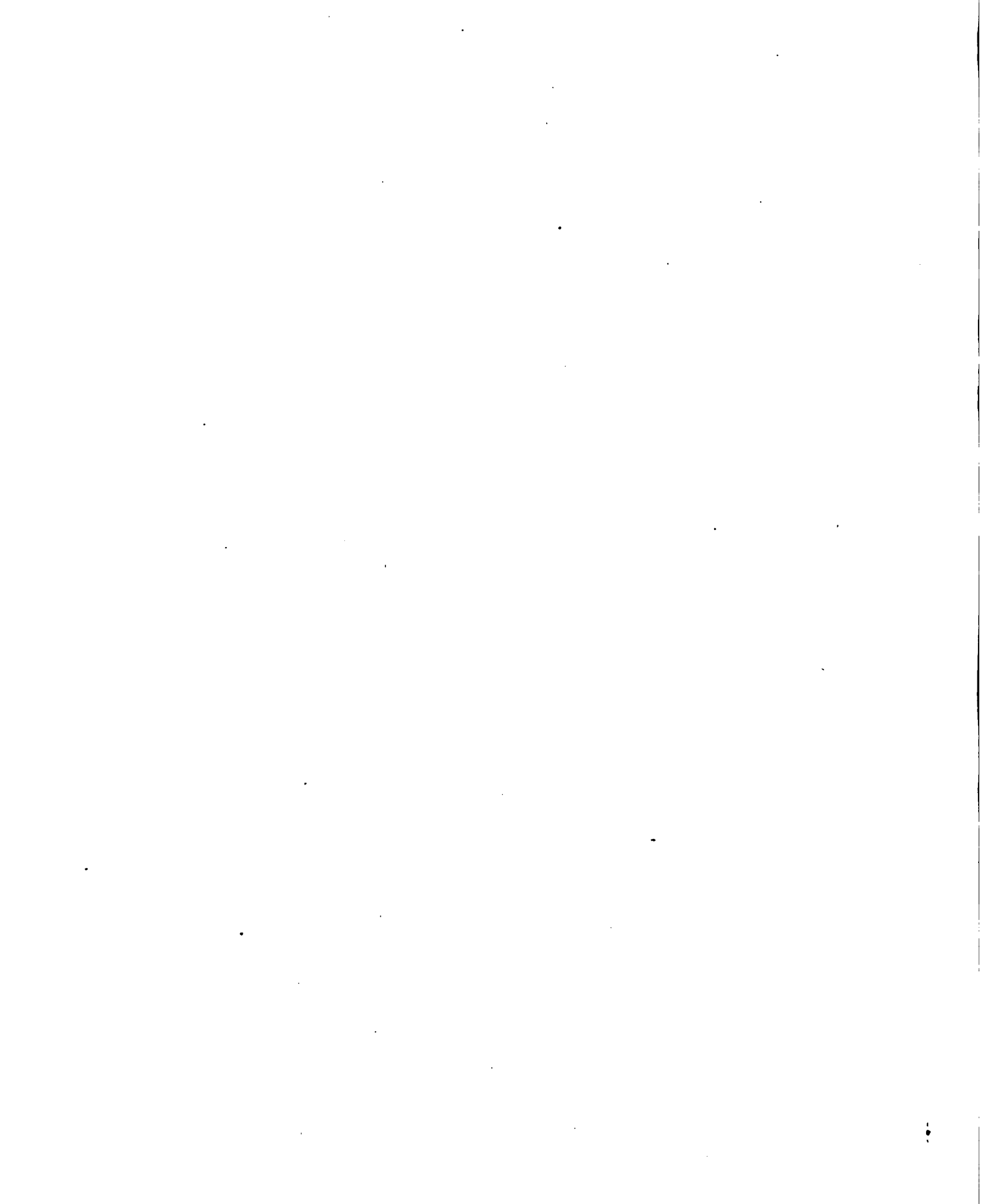


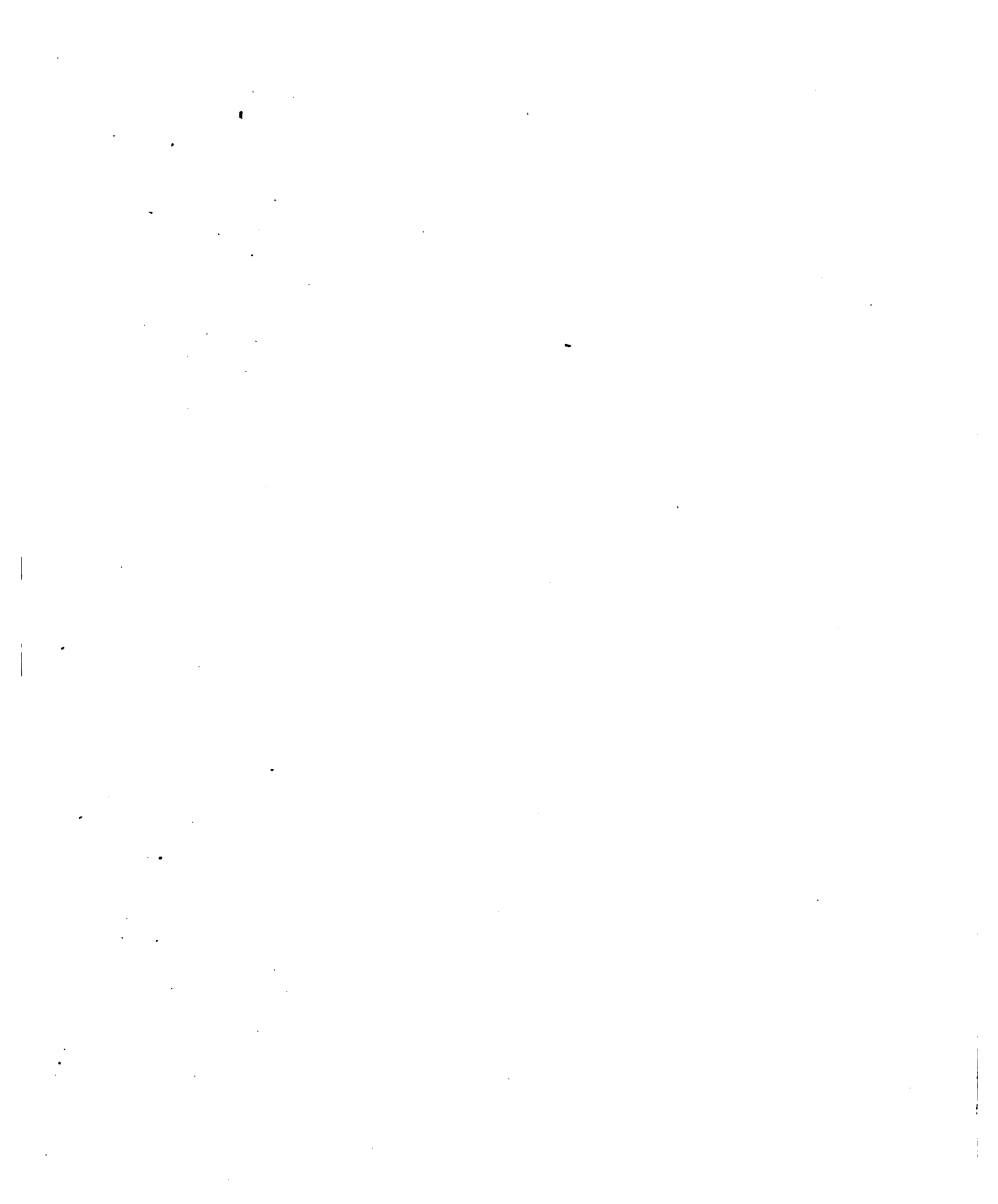






Gravé par J. Petiscolin.





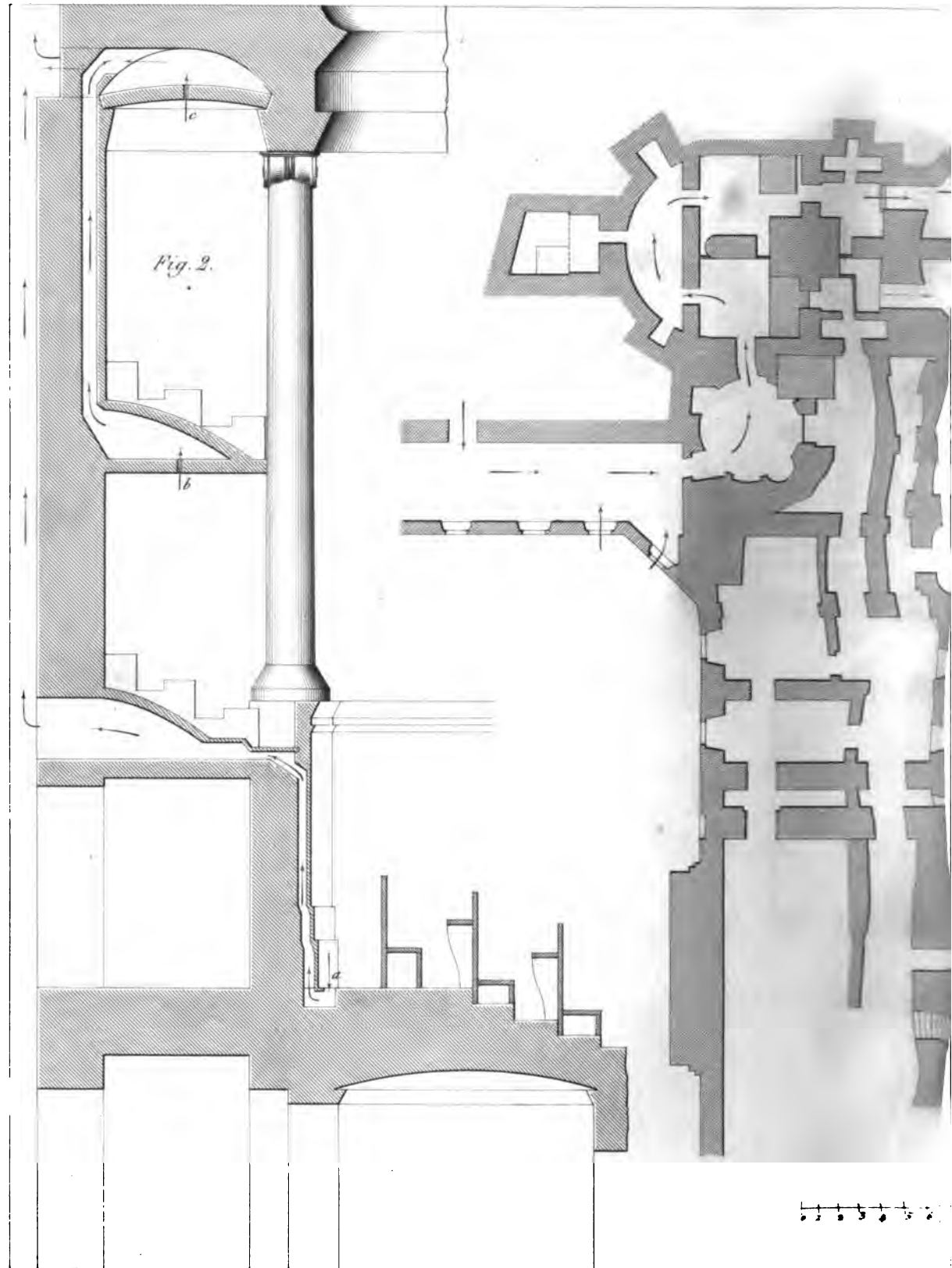
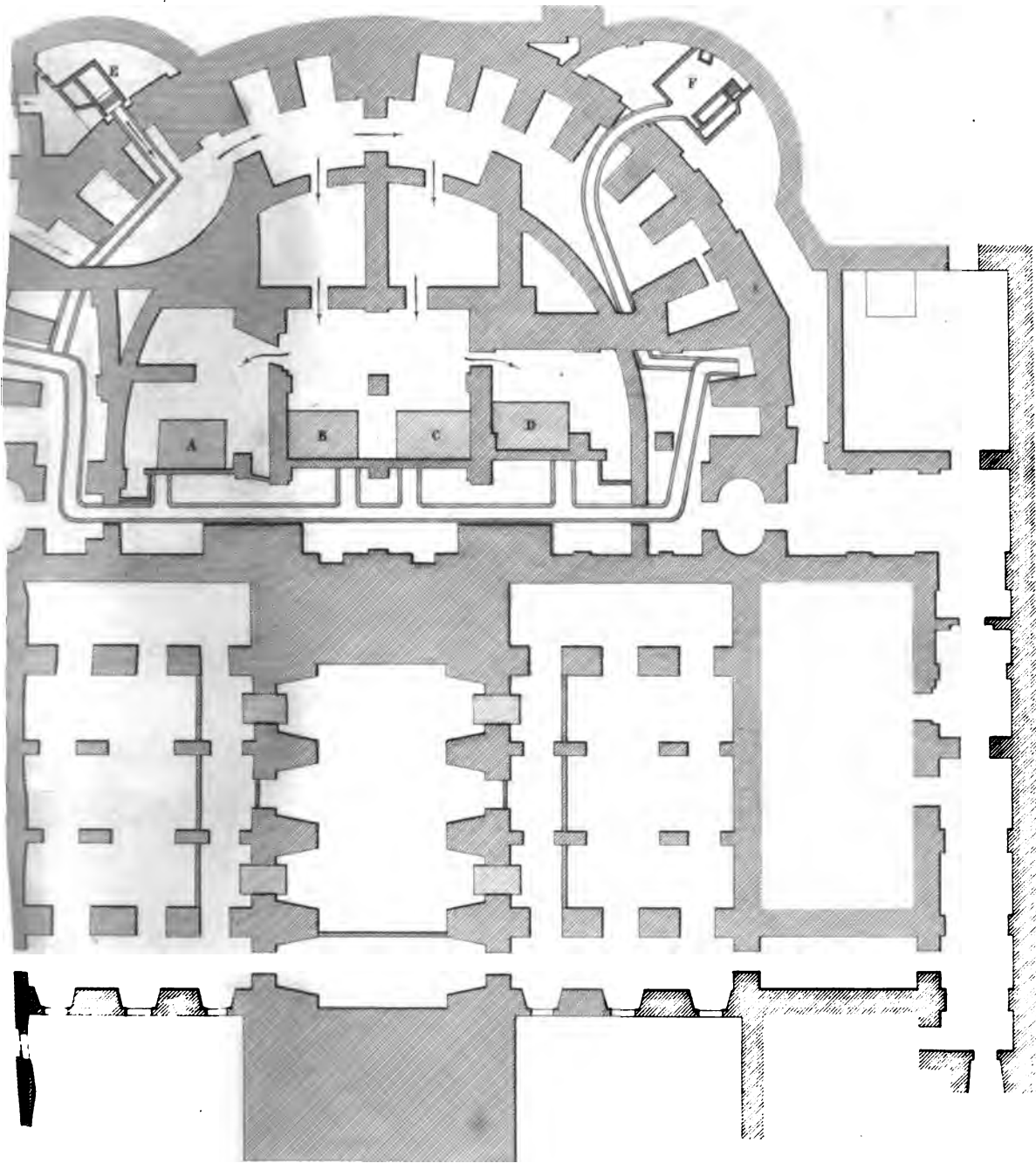
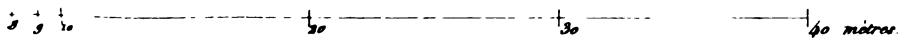
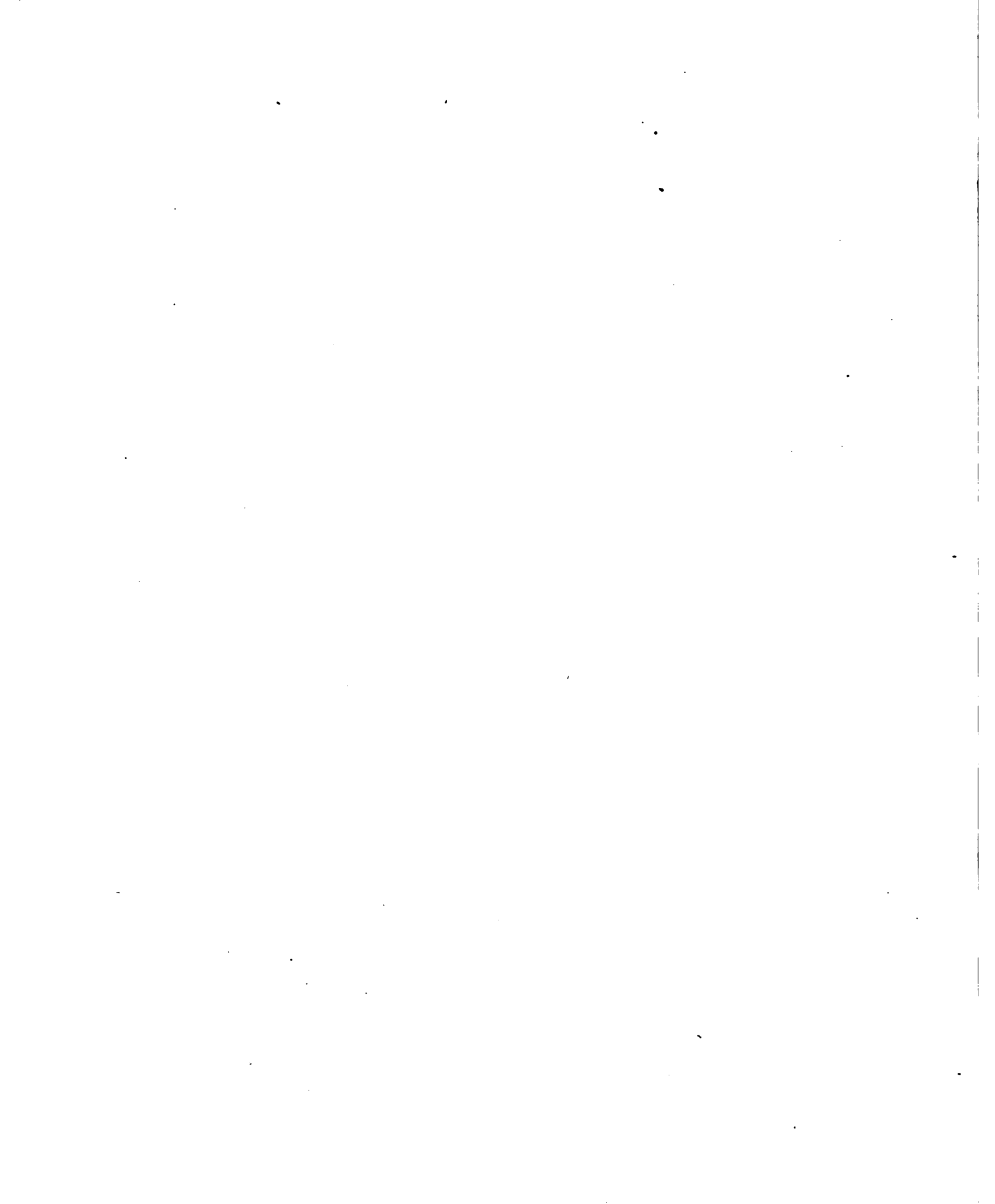


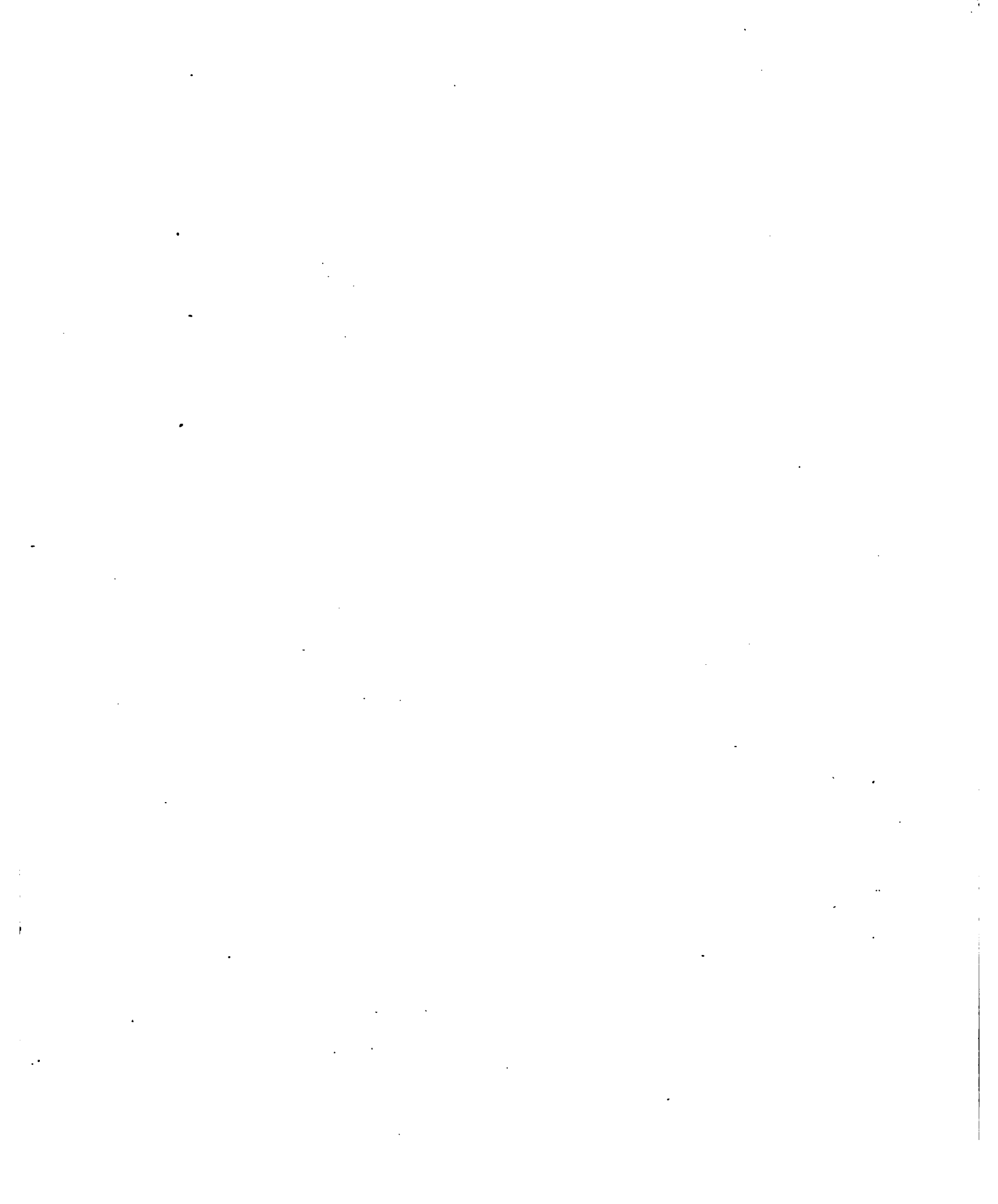
Fig. 1.

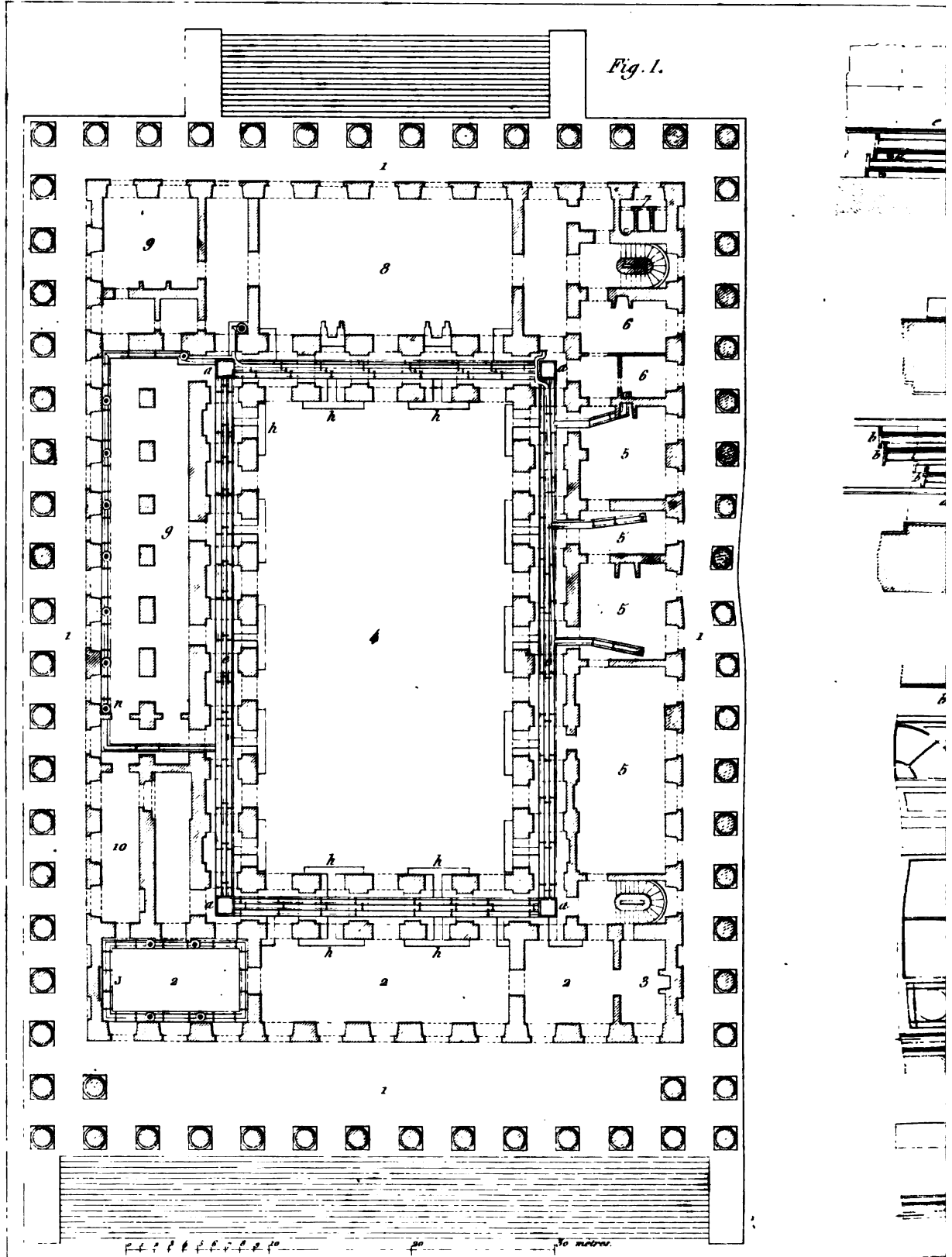


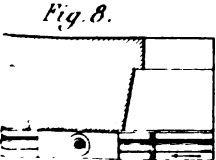
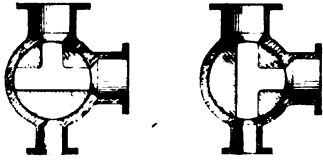
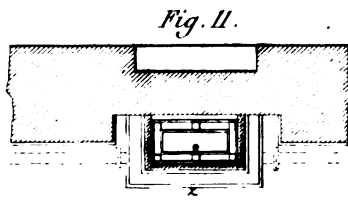
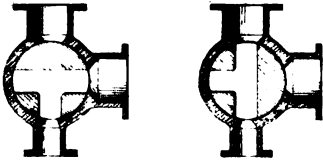
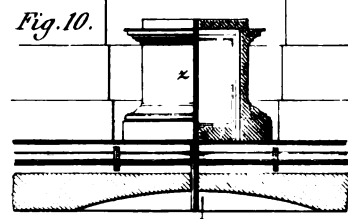
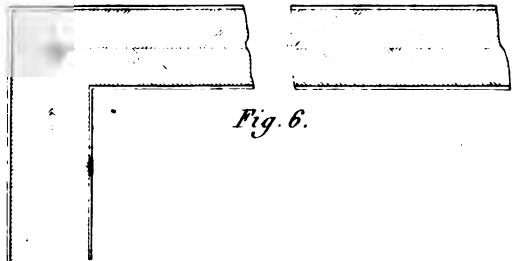
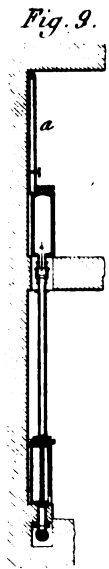
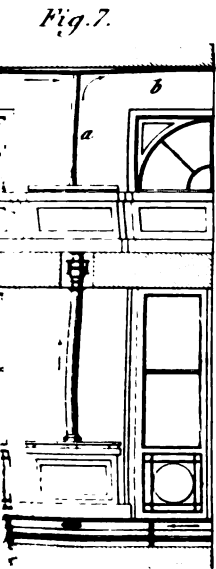
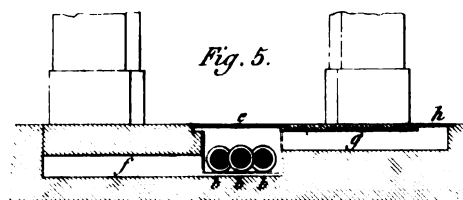
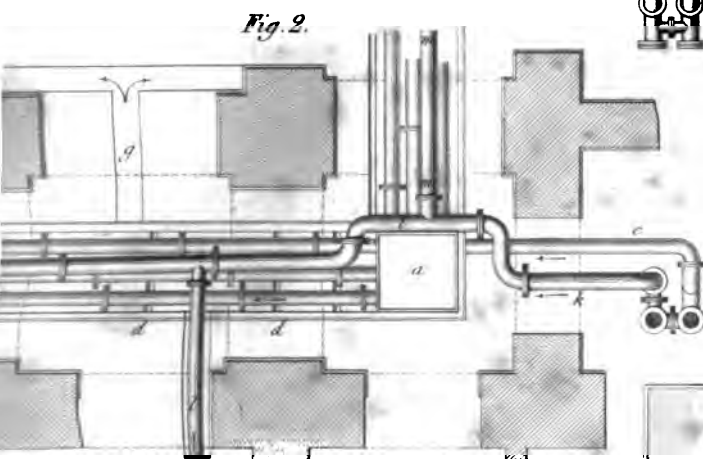
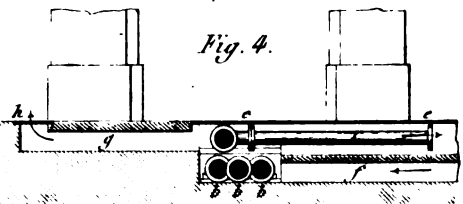
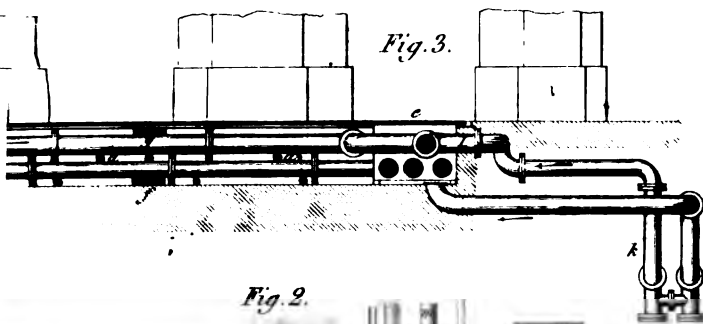
Echelle.



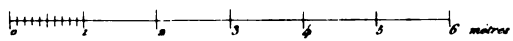


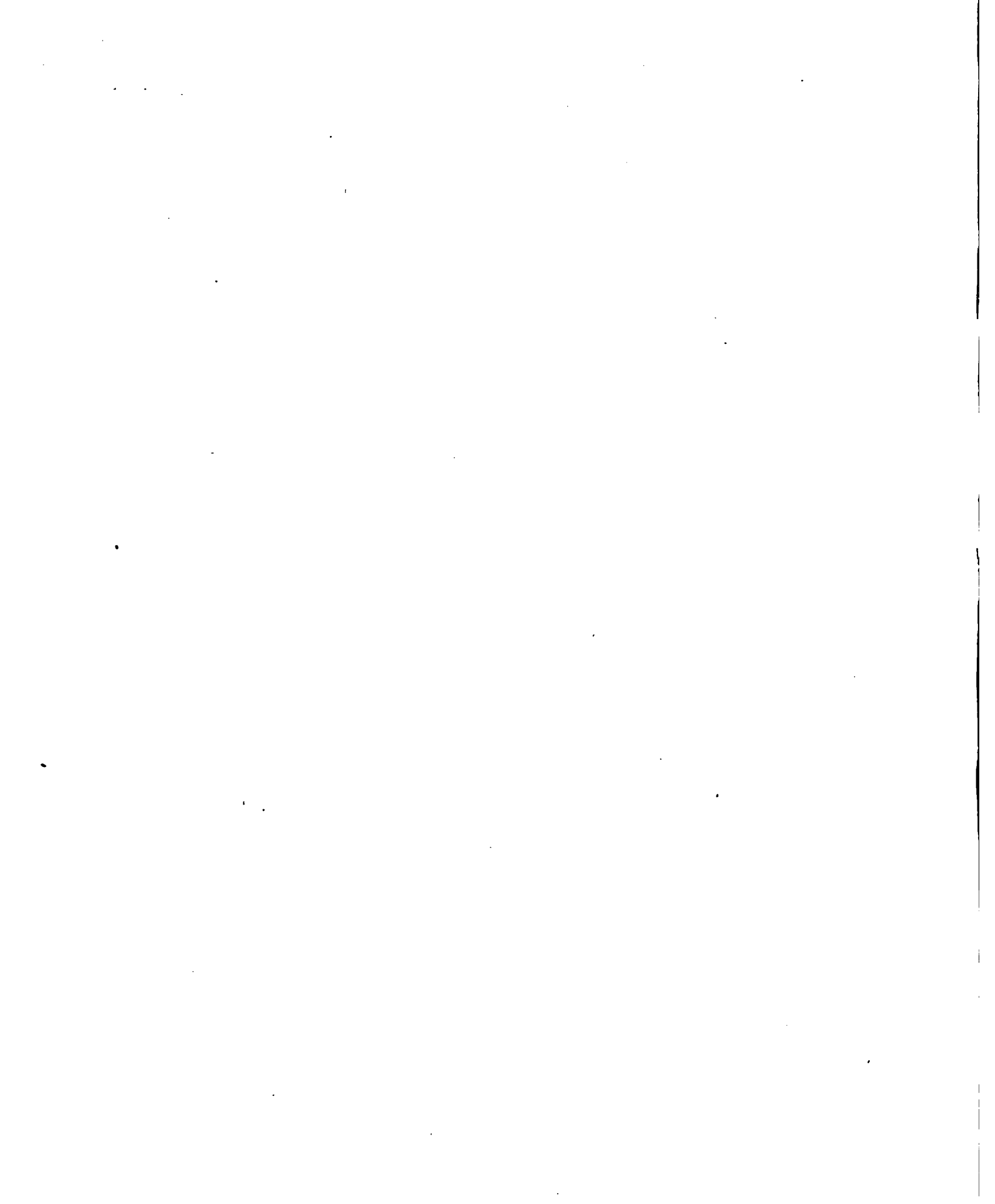


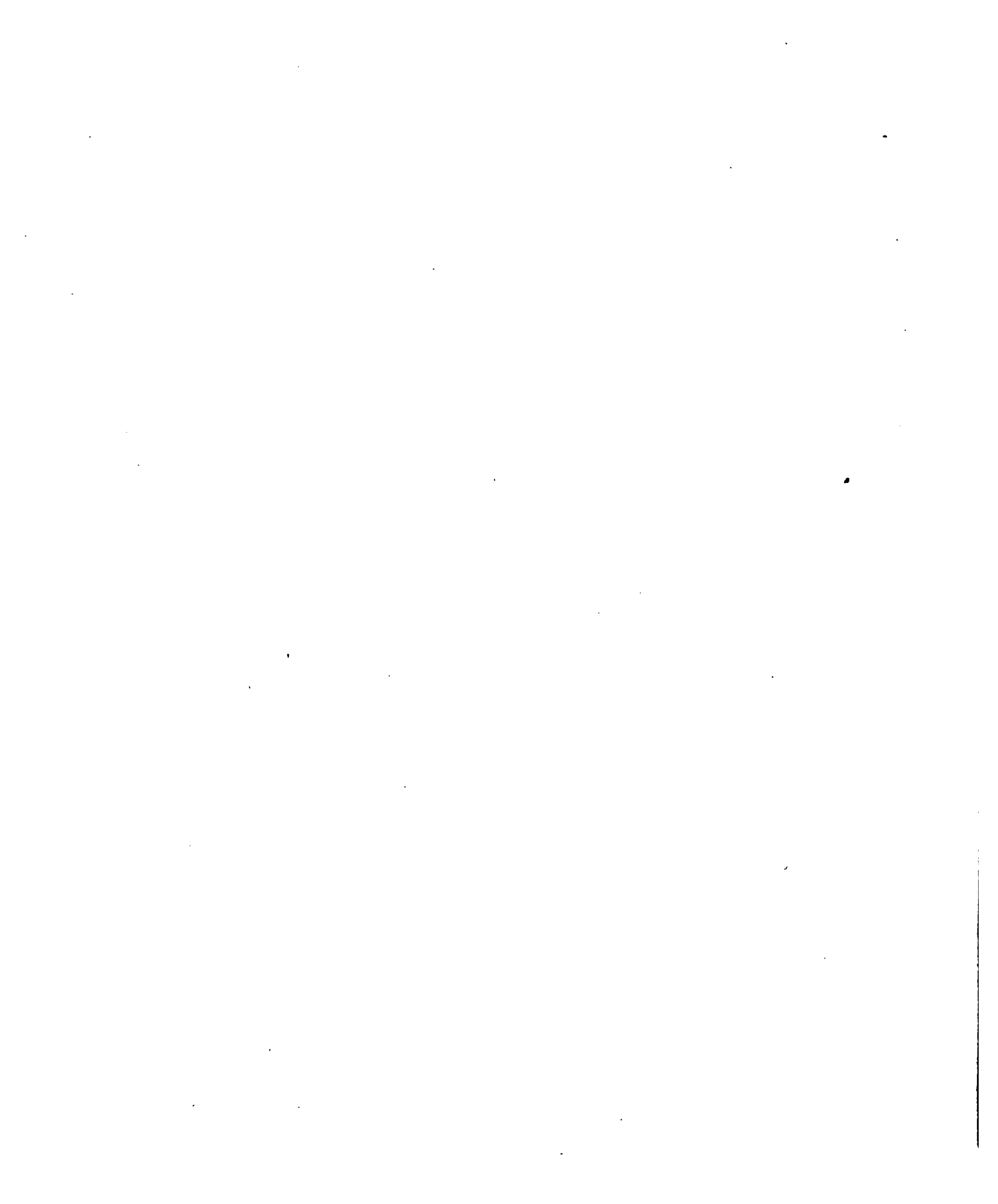




Echelle des Fig. 2, 3, 4, 5, 6, 7, 8, 9, 10 et 11.







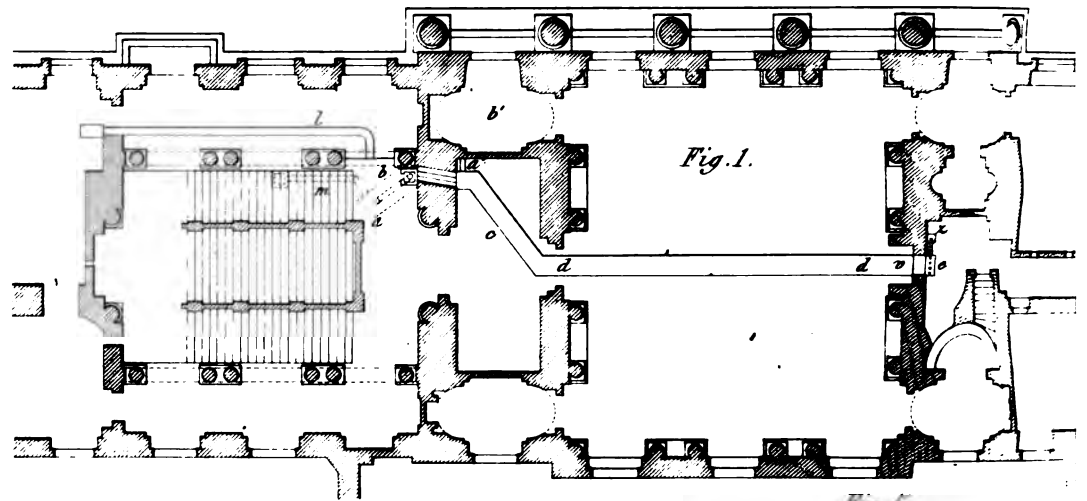


Fig. 1.

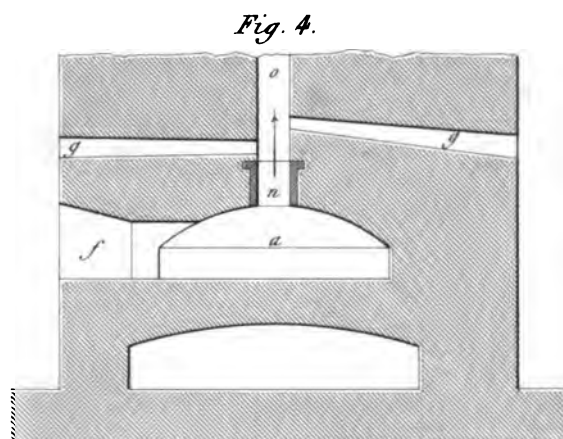


Fig. 4.

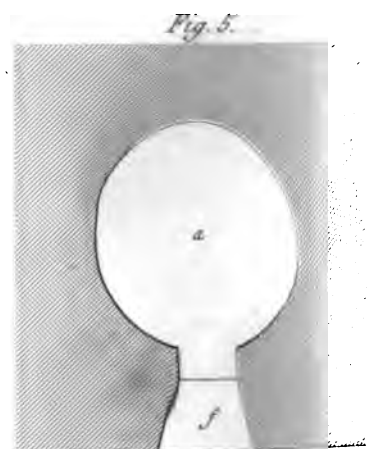


Fig. 5.

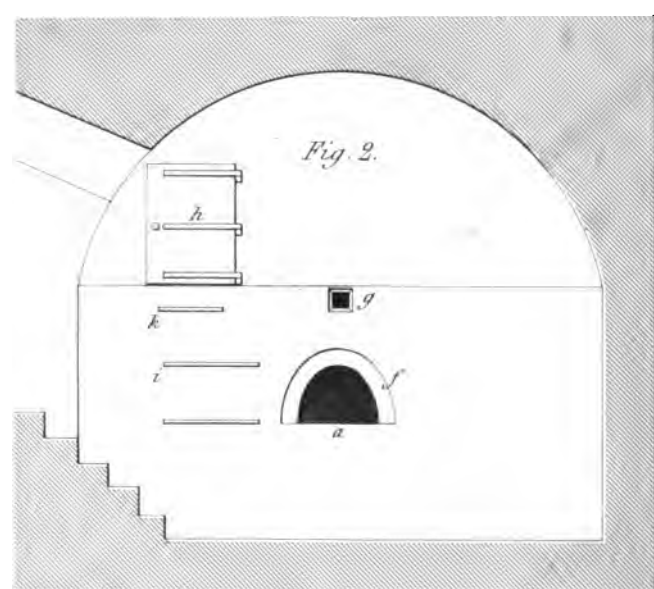


Fig. 2.

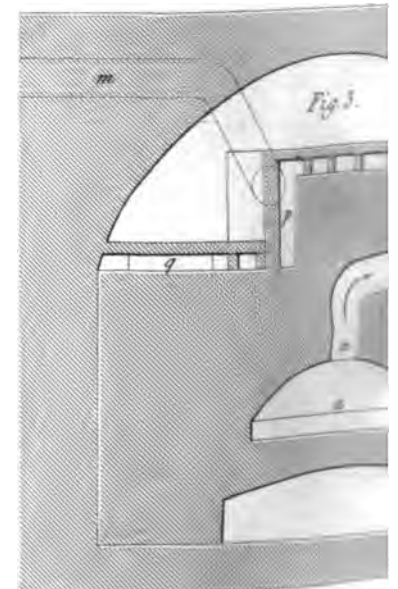
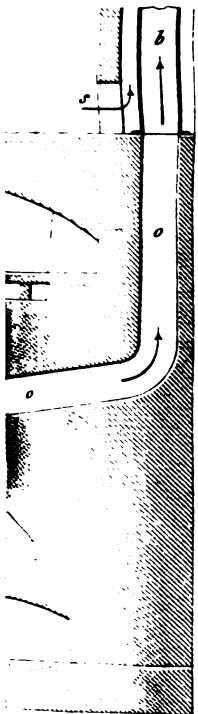
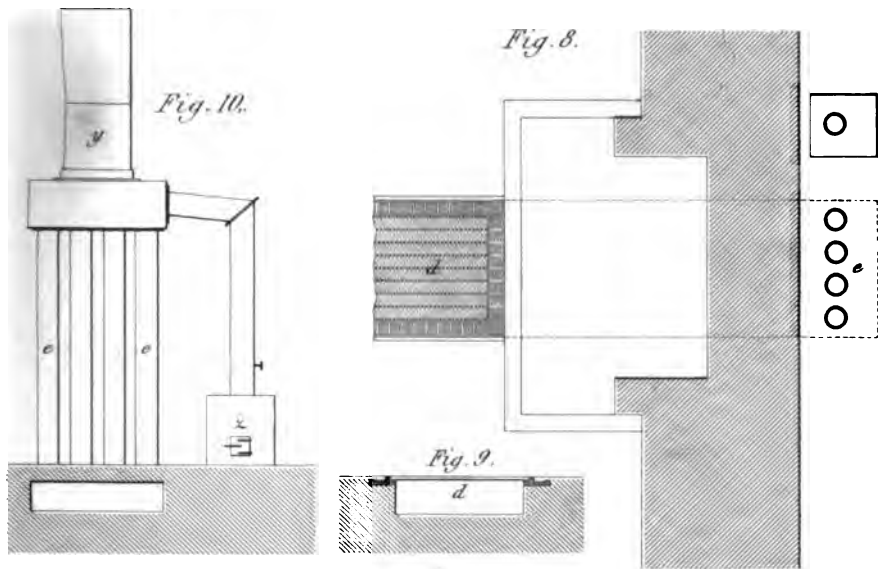
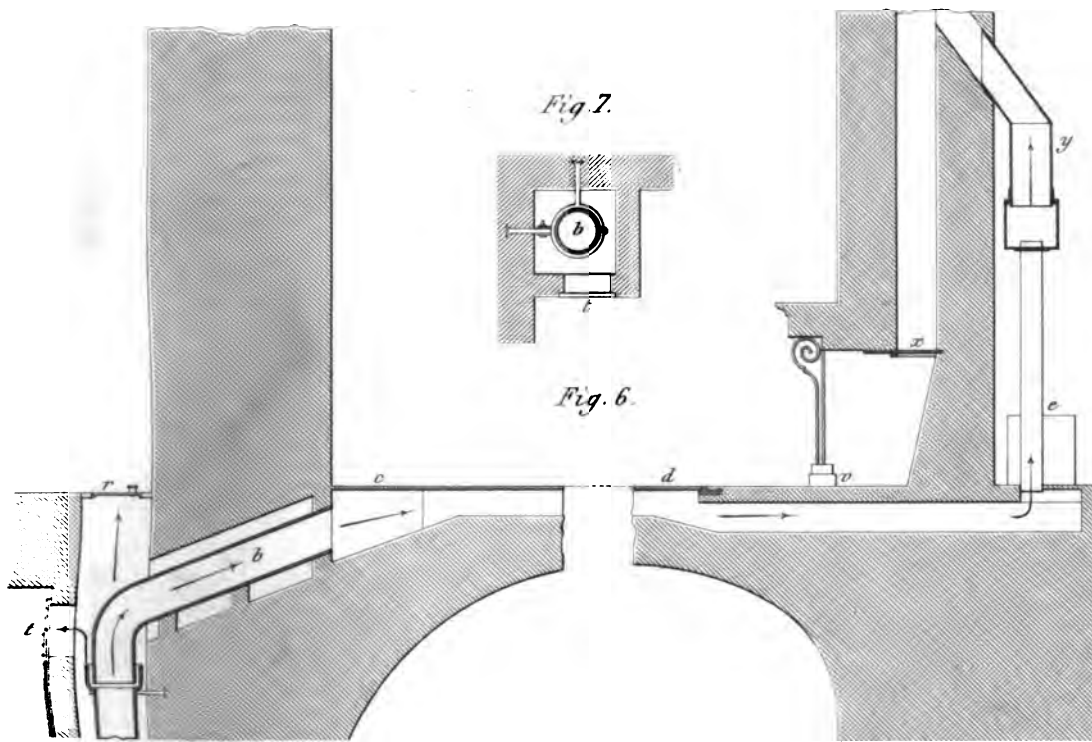
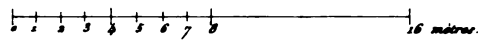


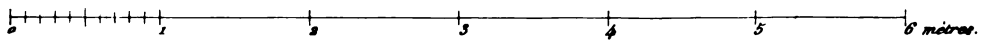
Fig. 3.

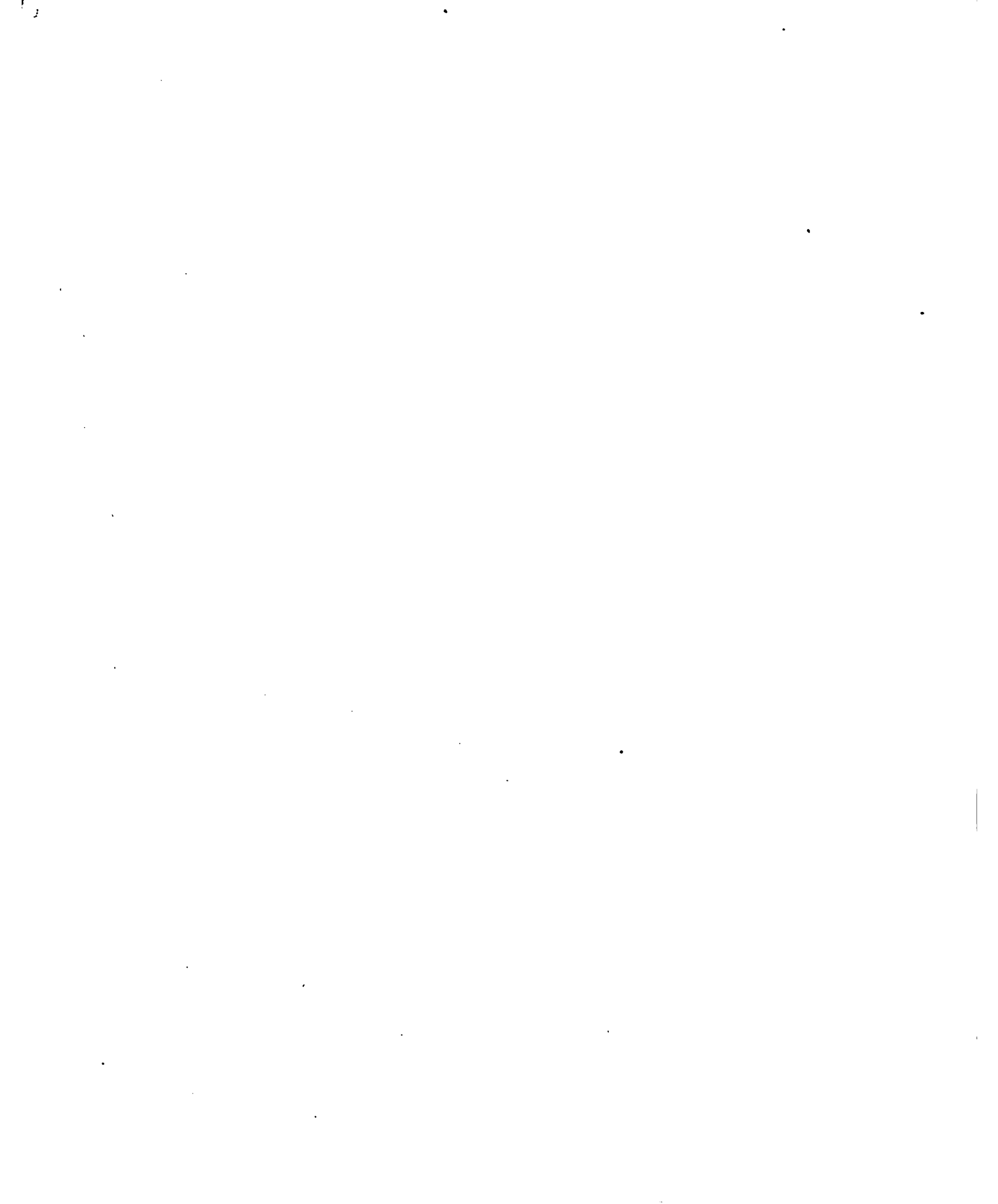


Echelle de la Fig. 1.



Echelle des Fig. 2, 3, 4, 5, 6, 7, 8 et 9.





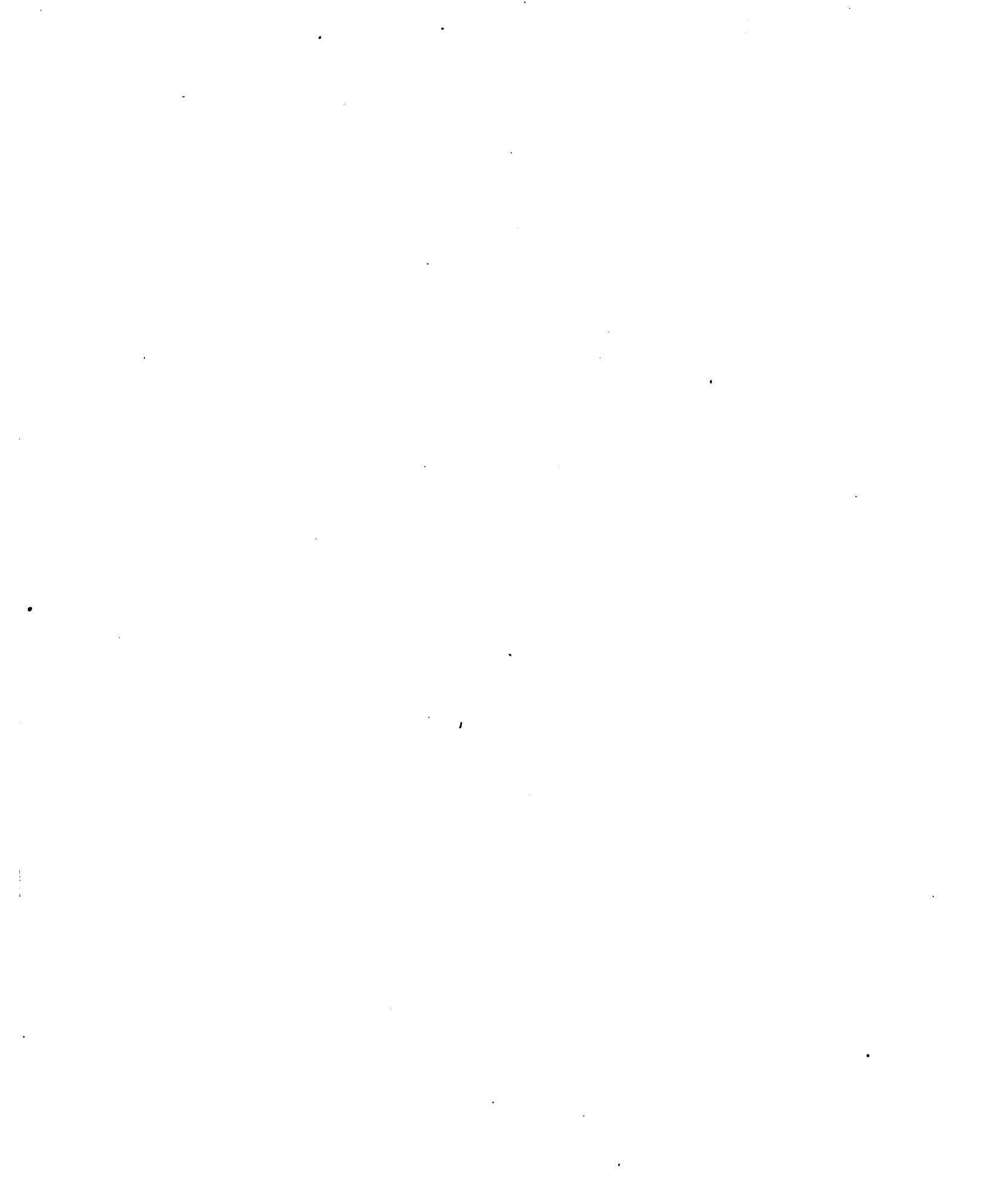


Fig. 1.

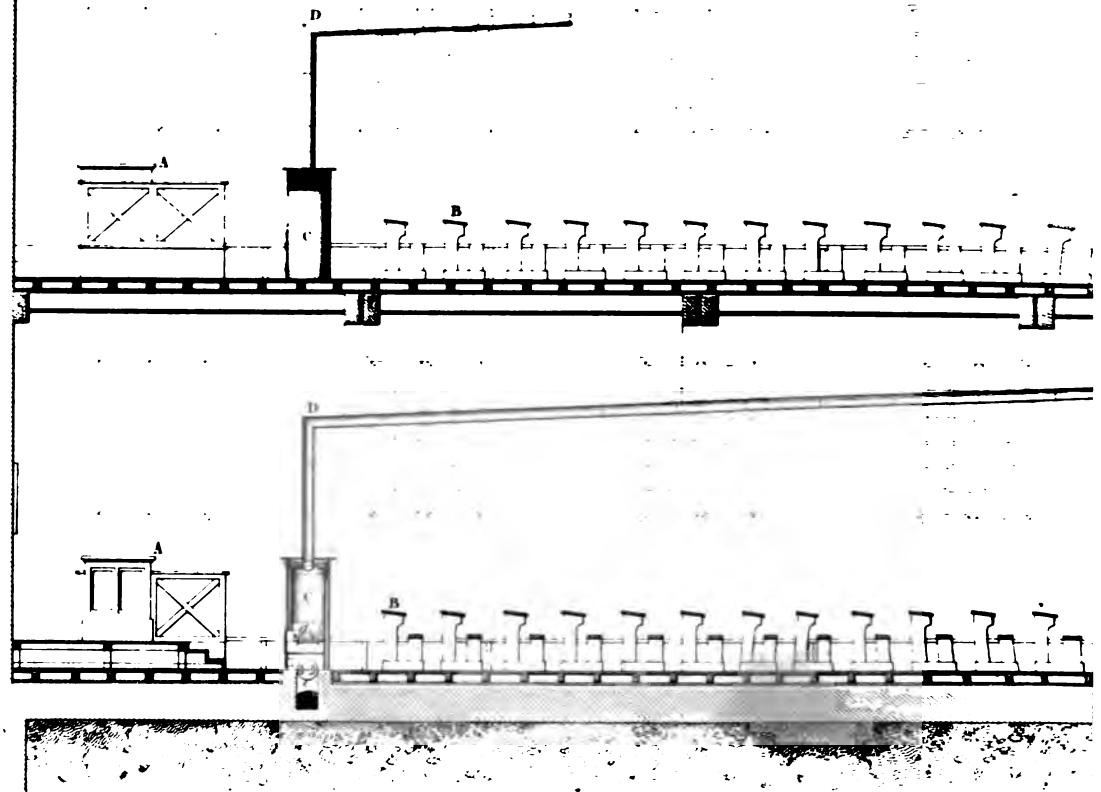
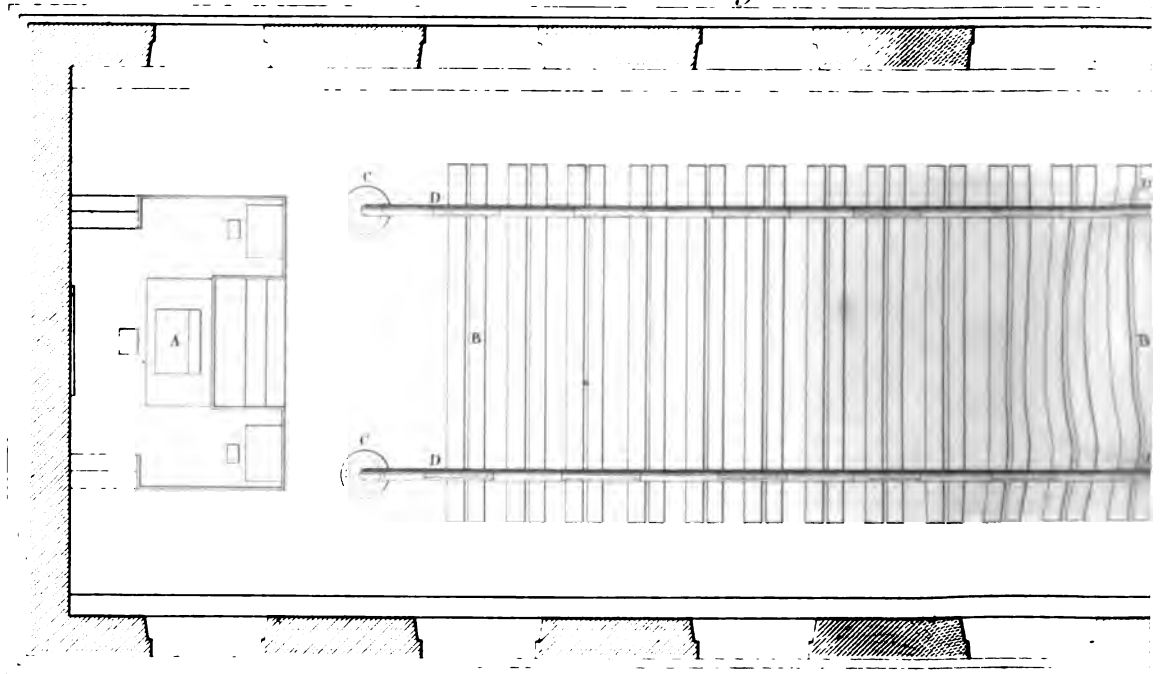
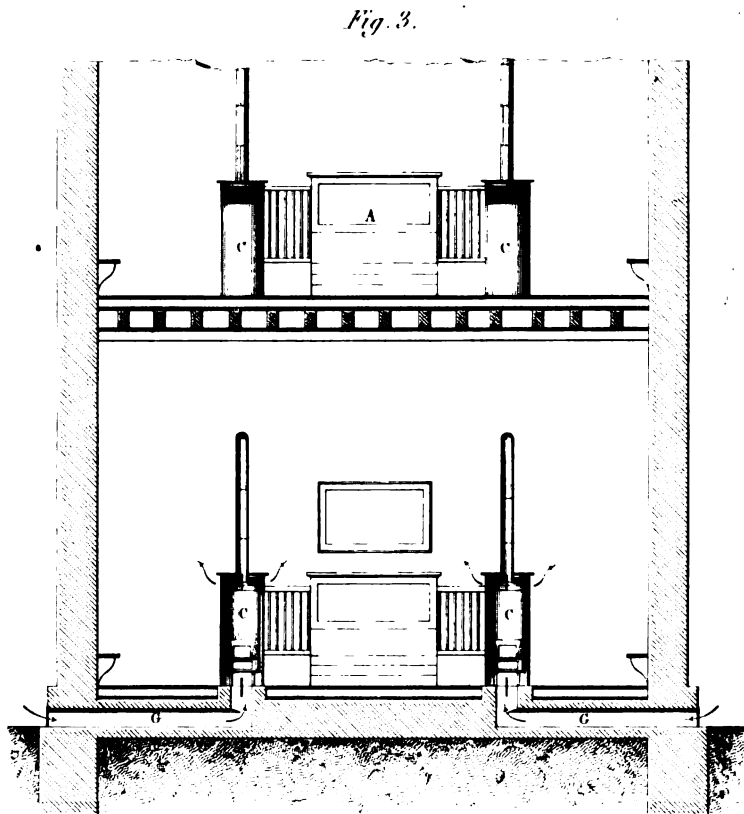
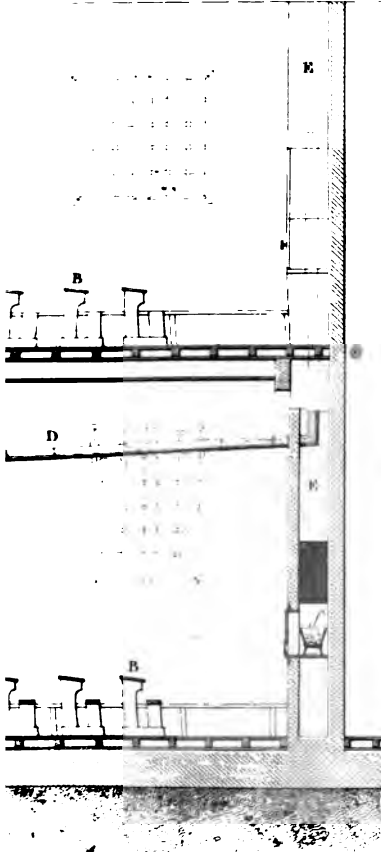


Fig. 2.





Echelle.

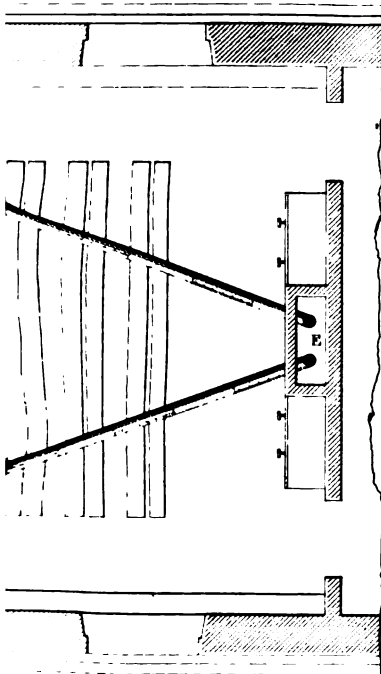
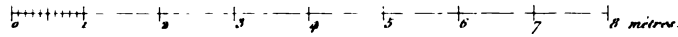
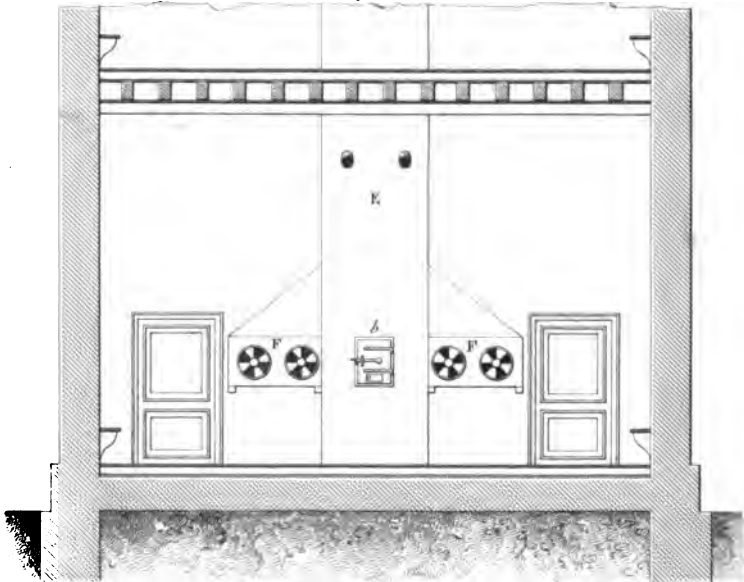
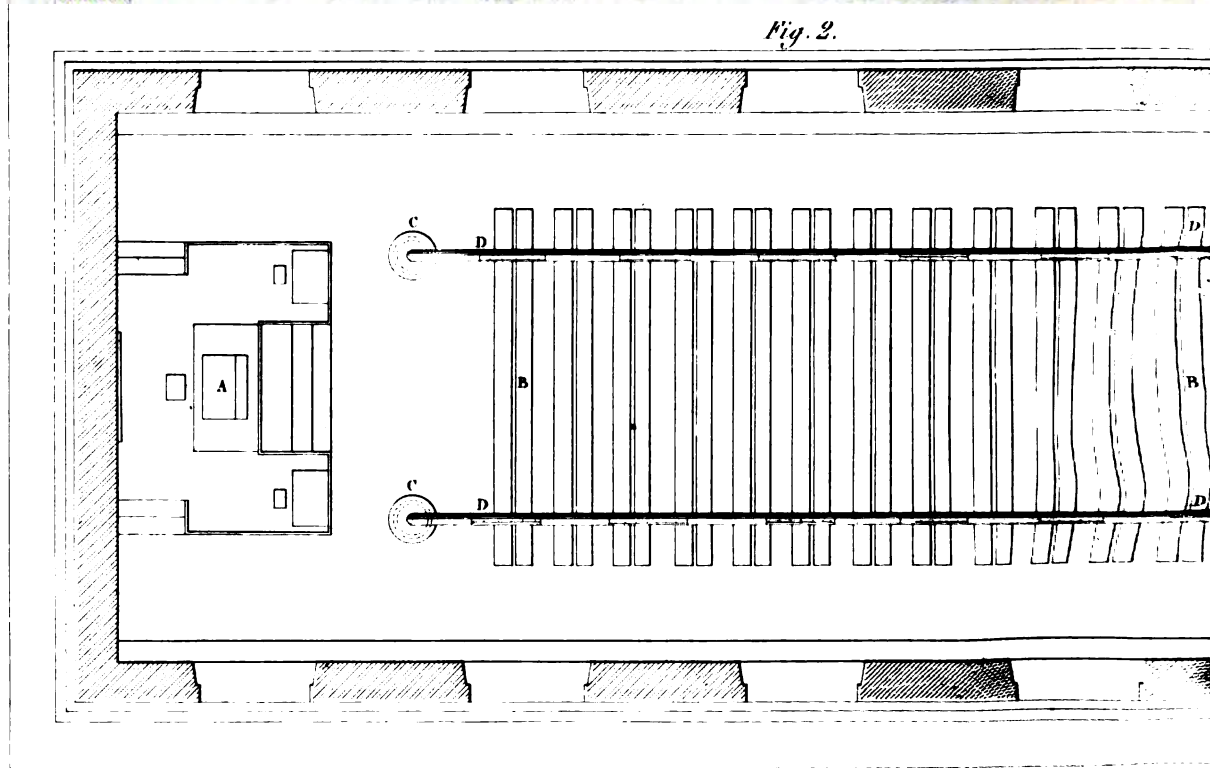
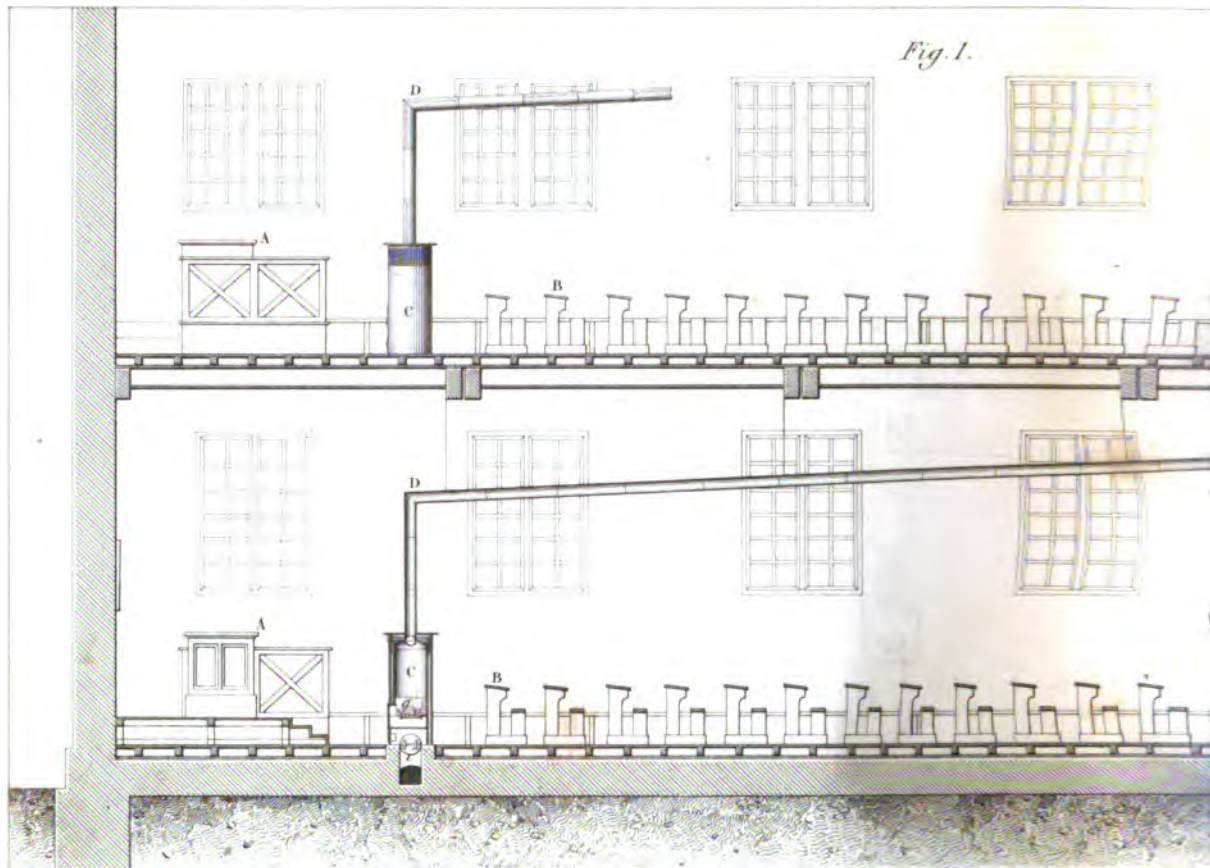


Fig. 4.





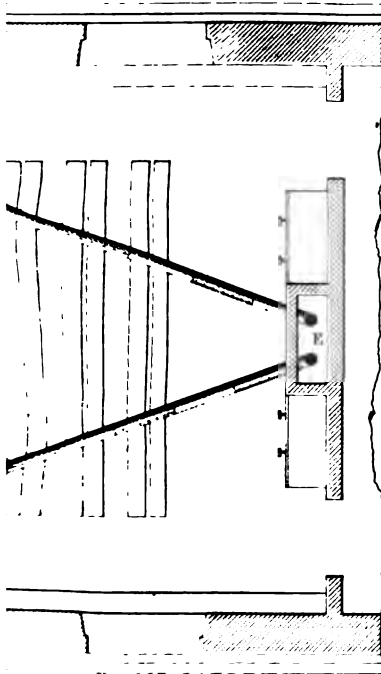
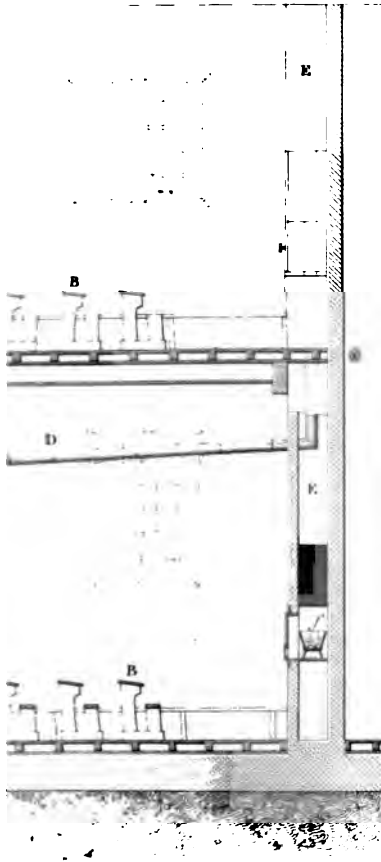
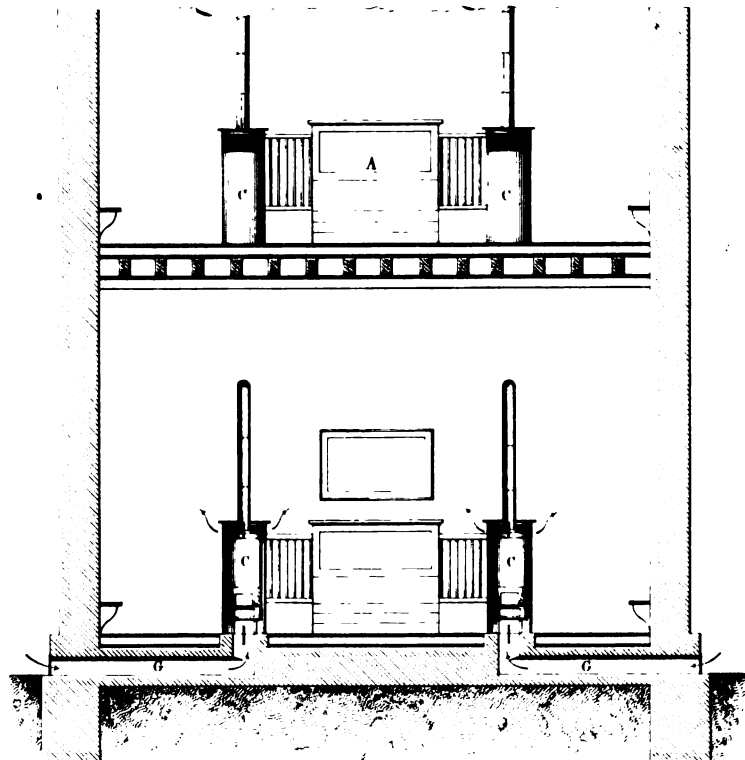


Fig. 3.



Echelle.

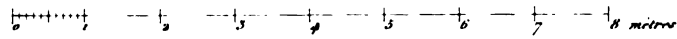
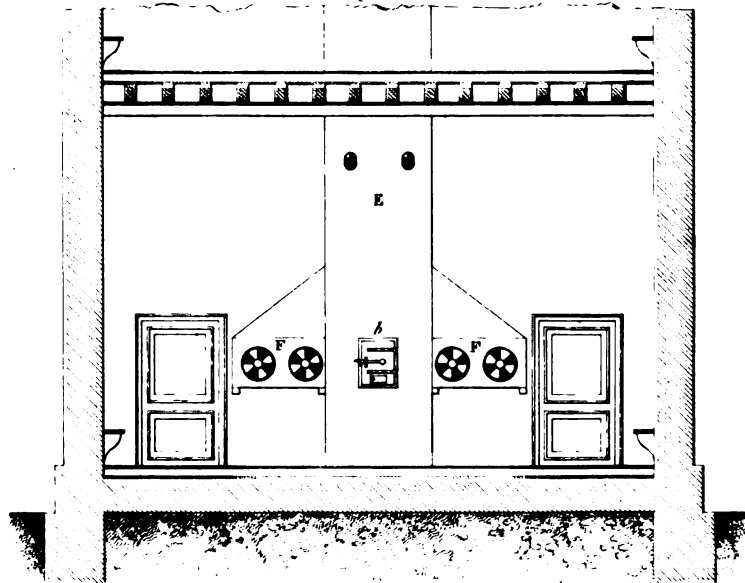
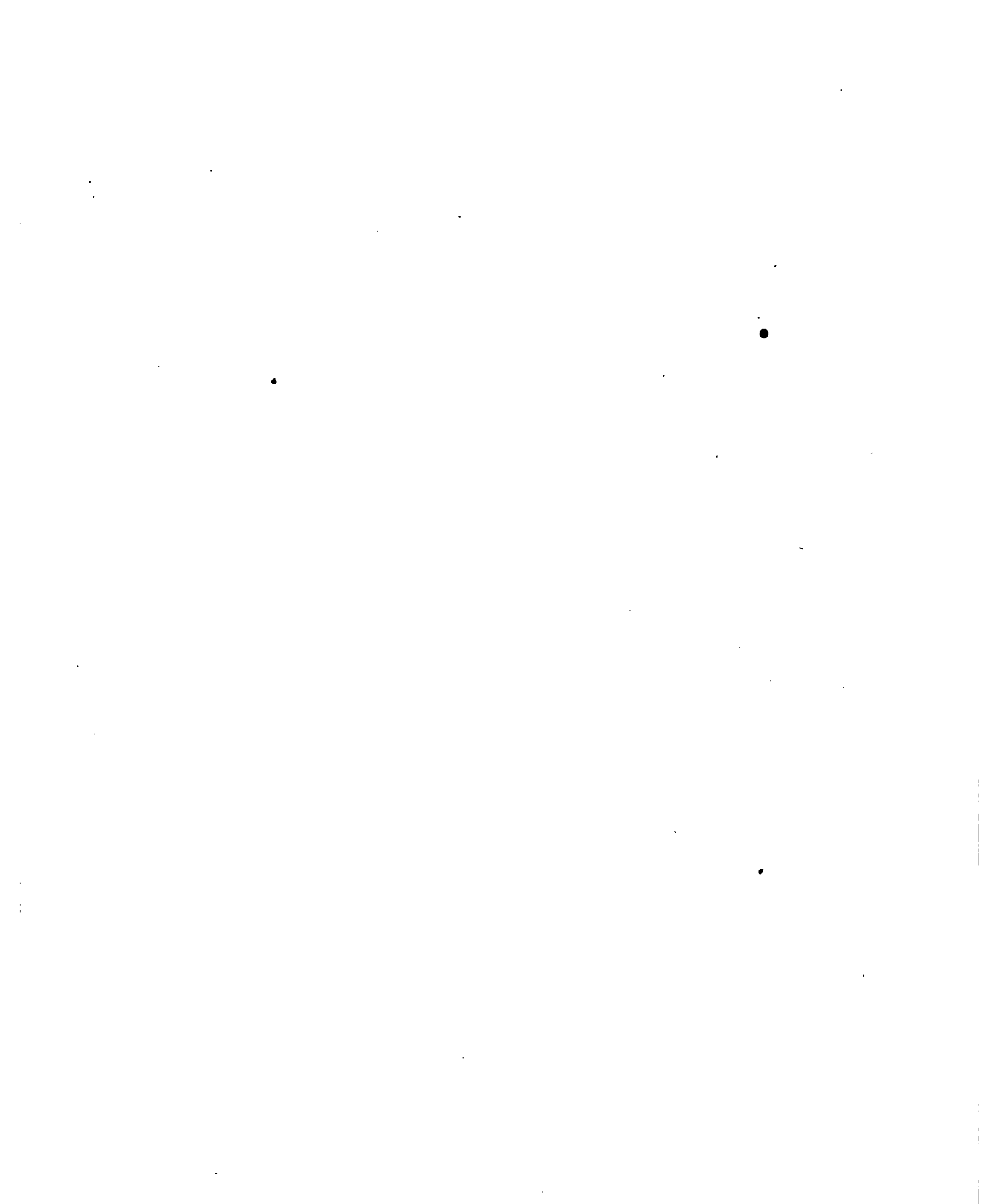
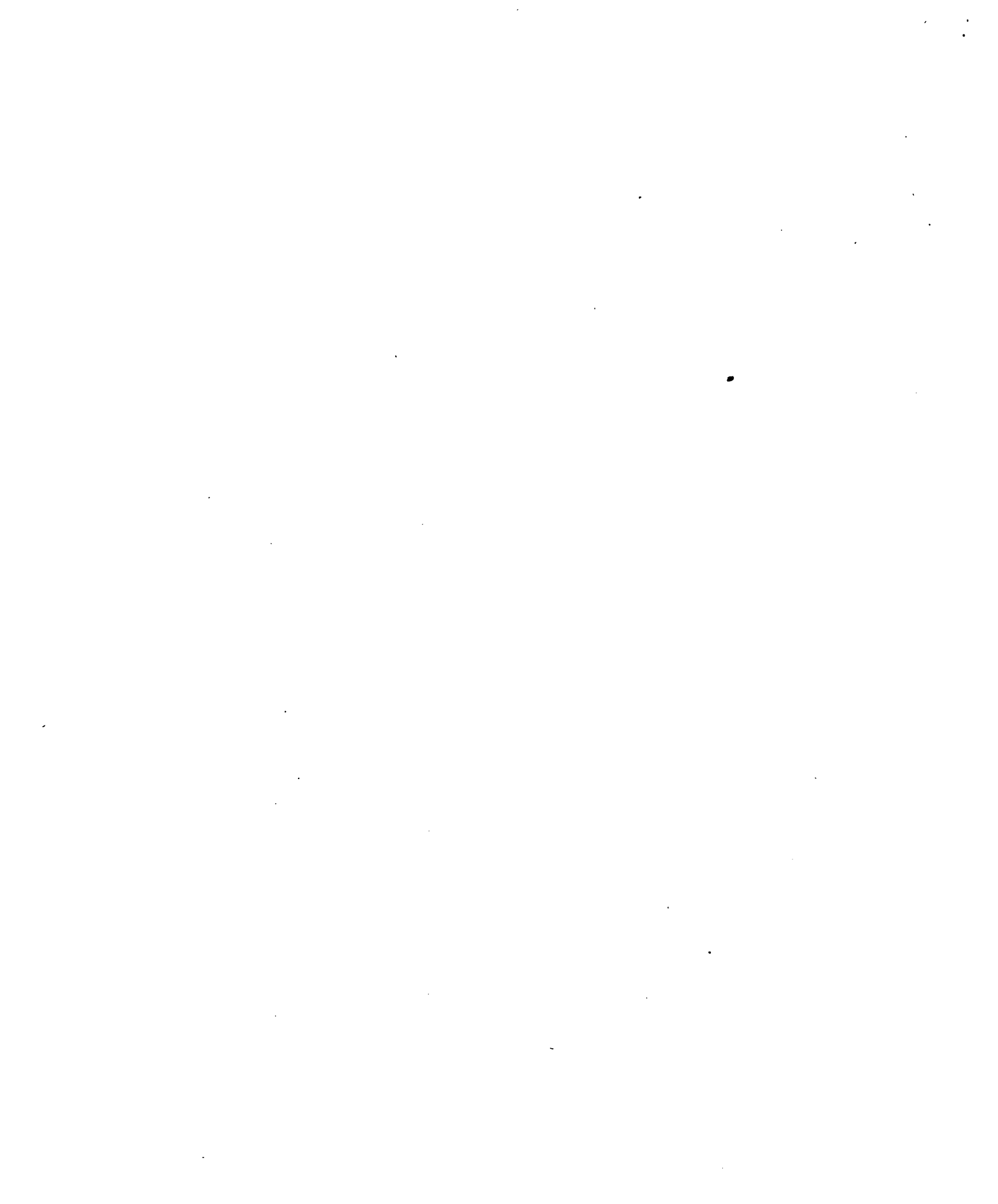
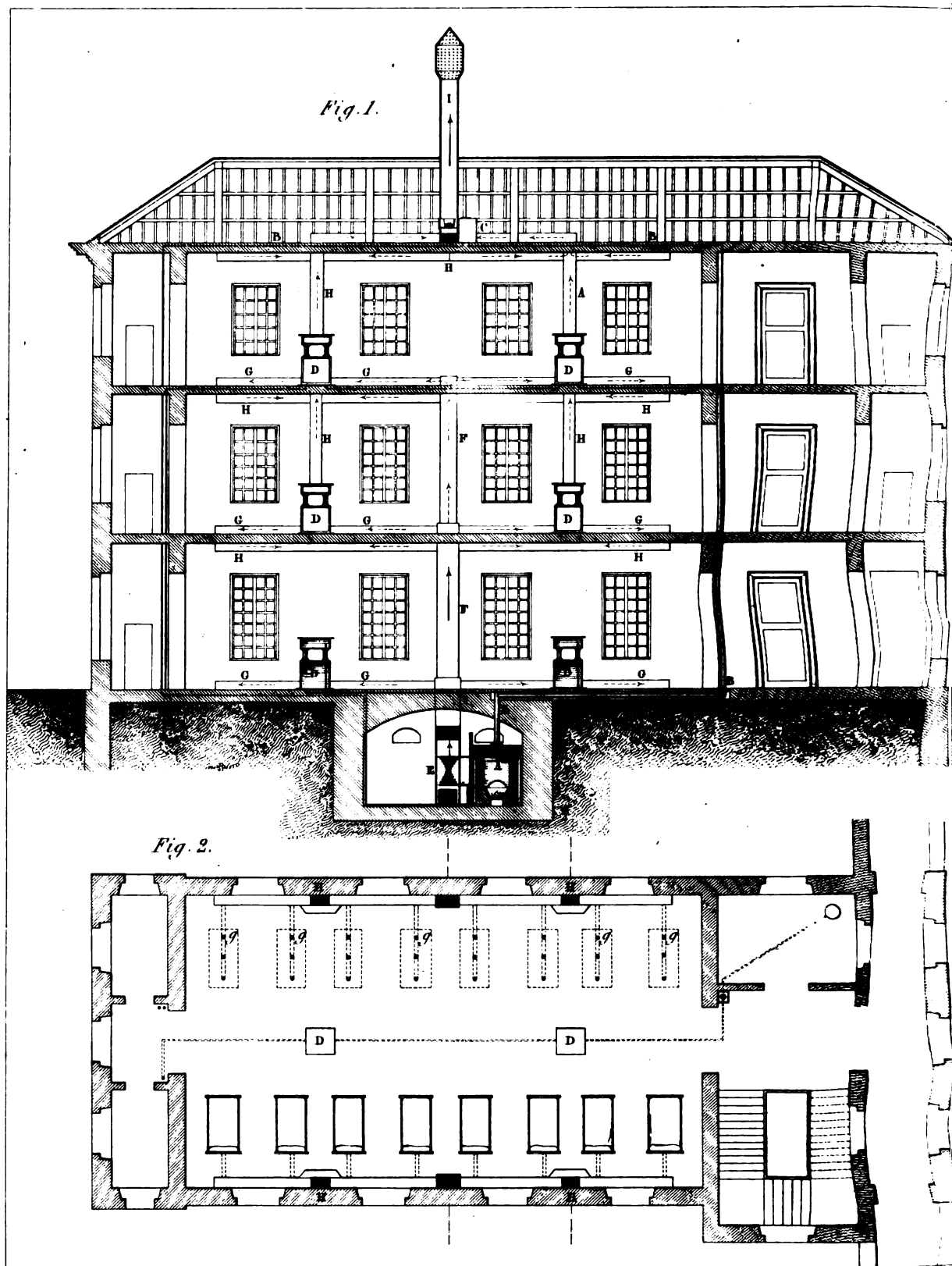


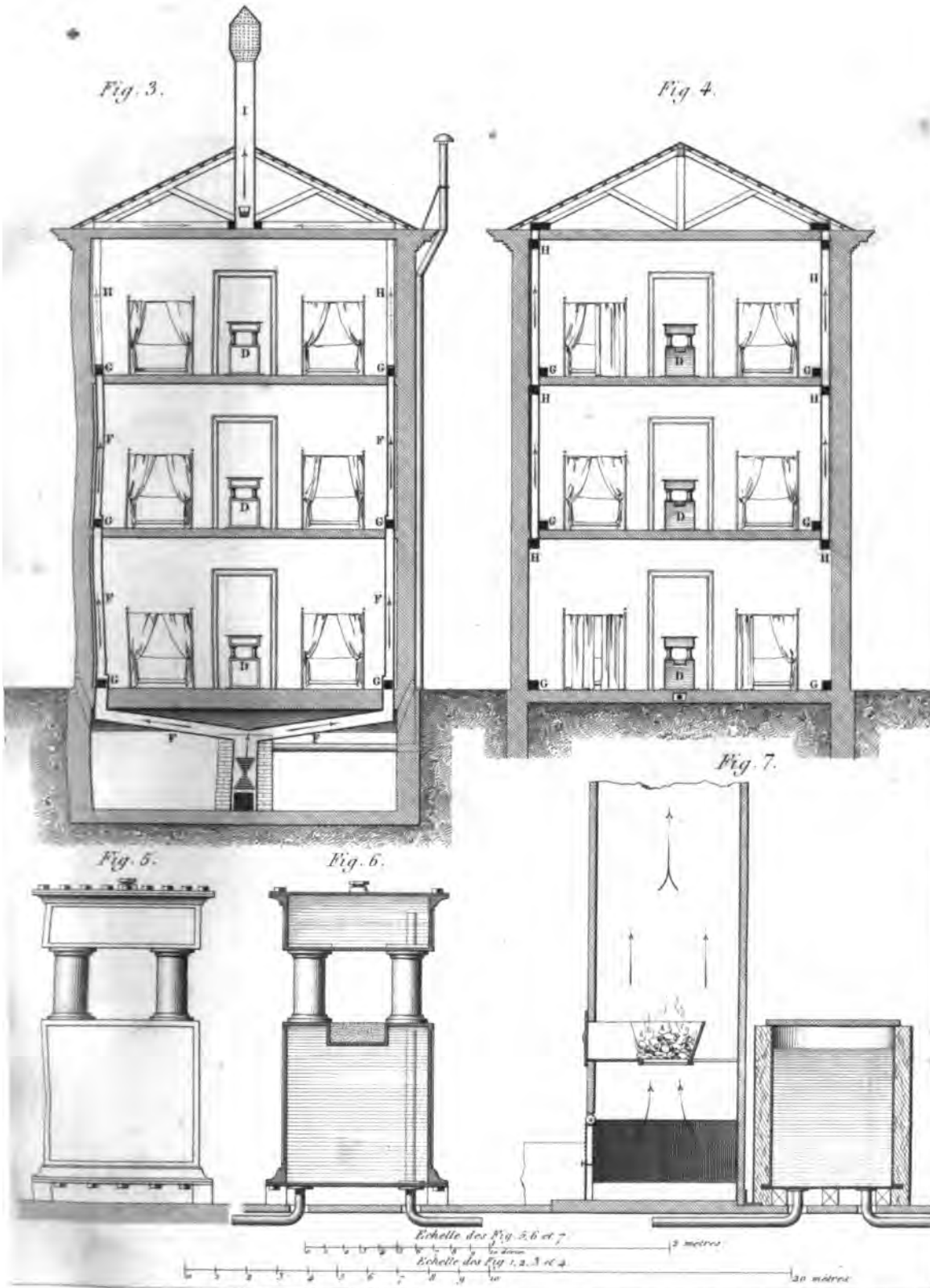
Fig. 4.



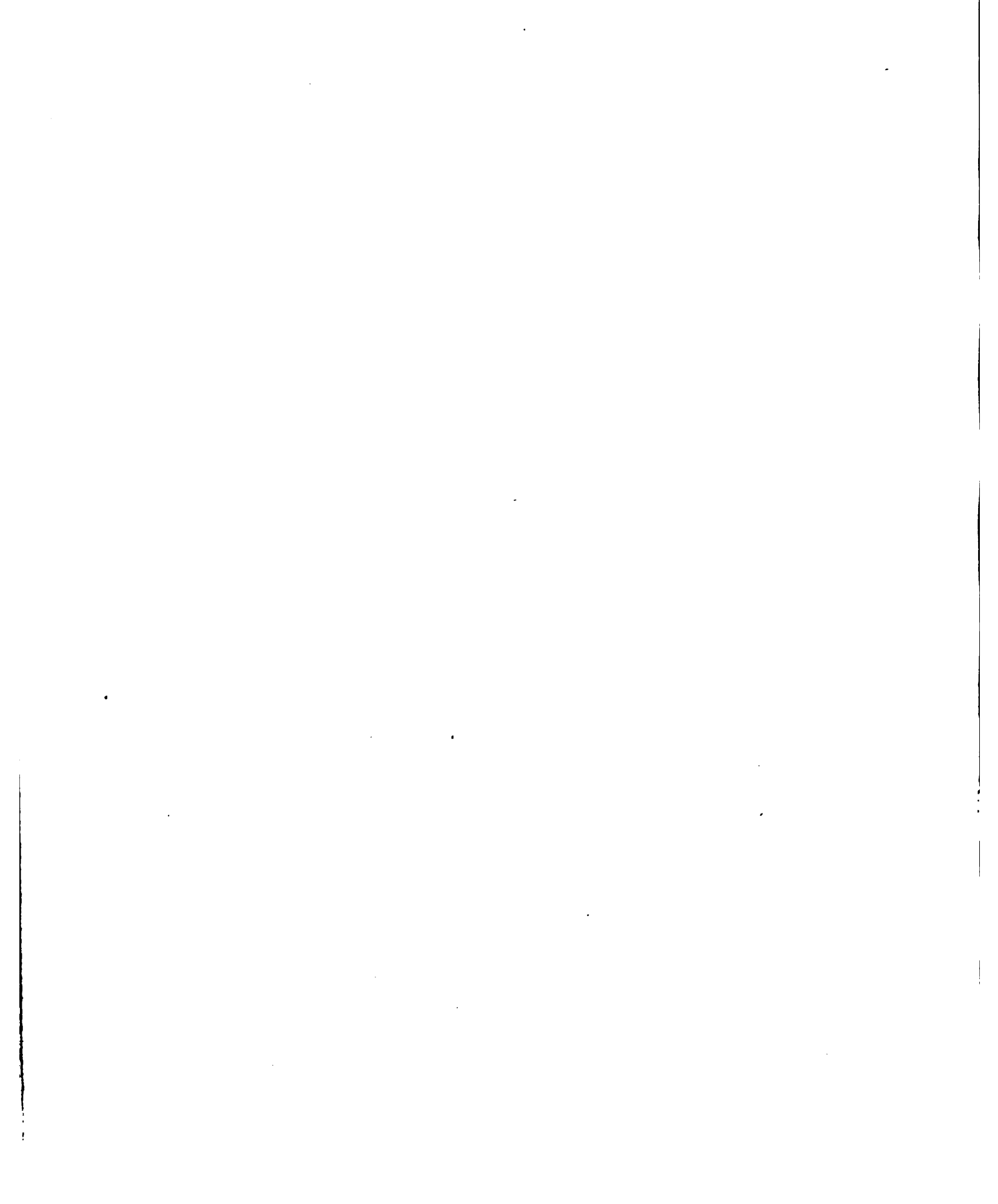








Créé par E. Karmser.



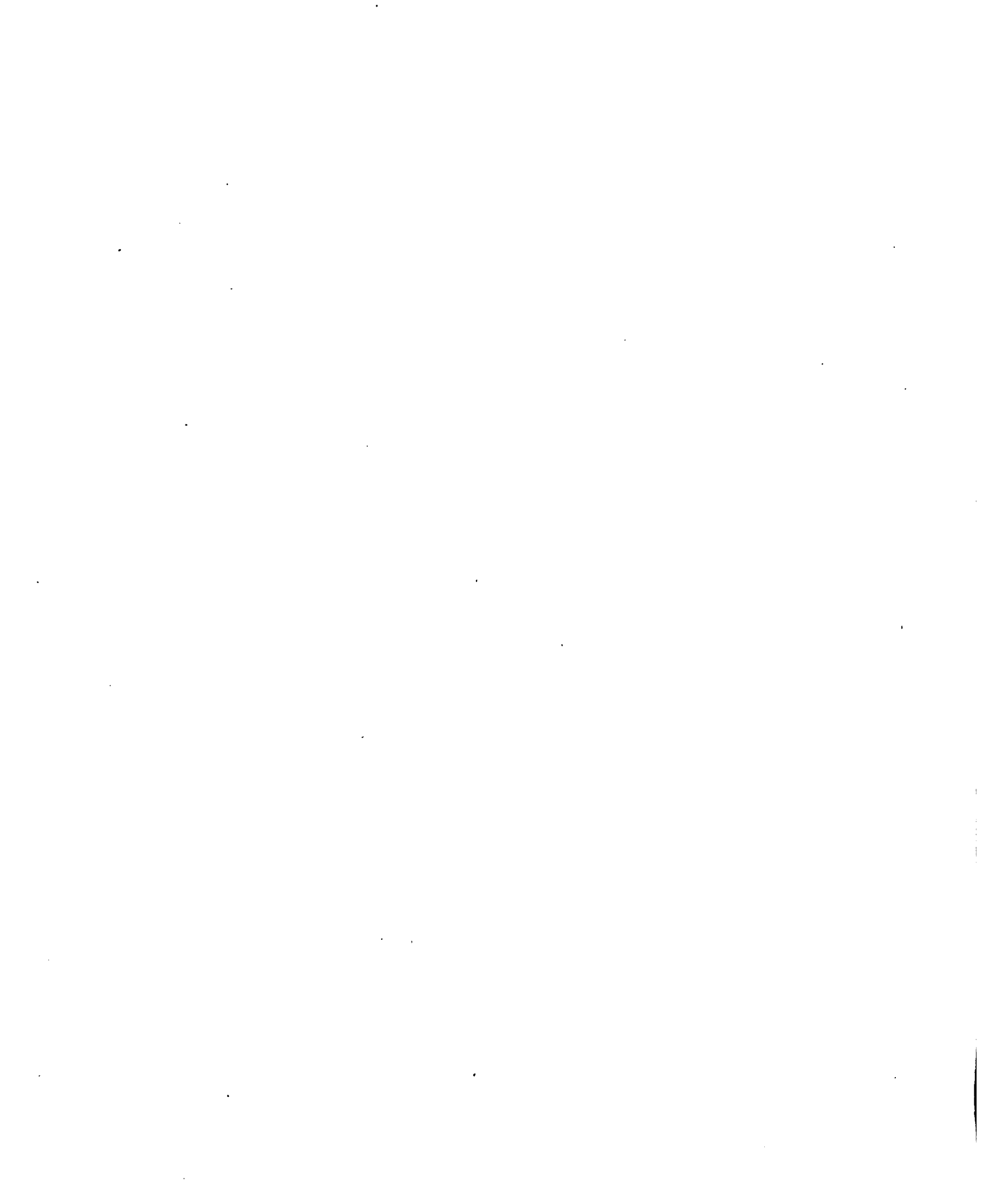
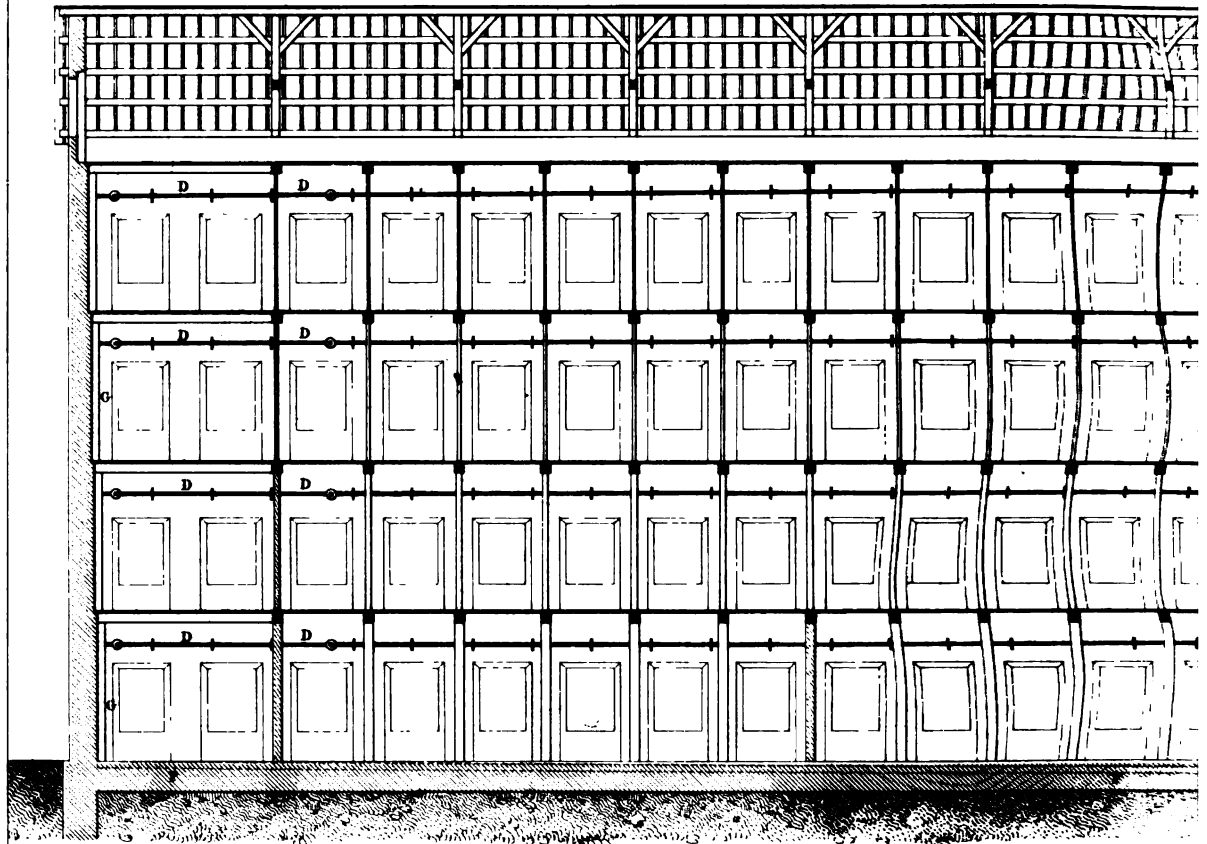


Fig. 1.



Echelle.

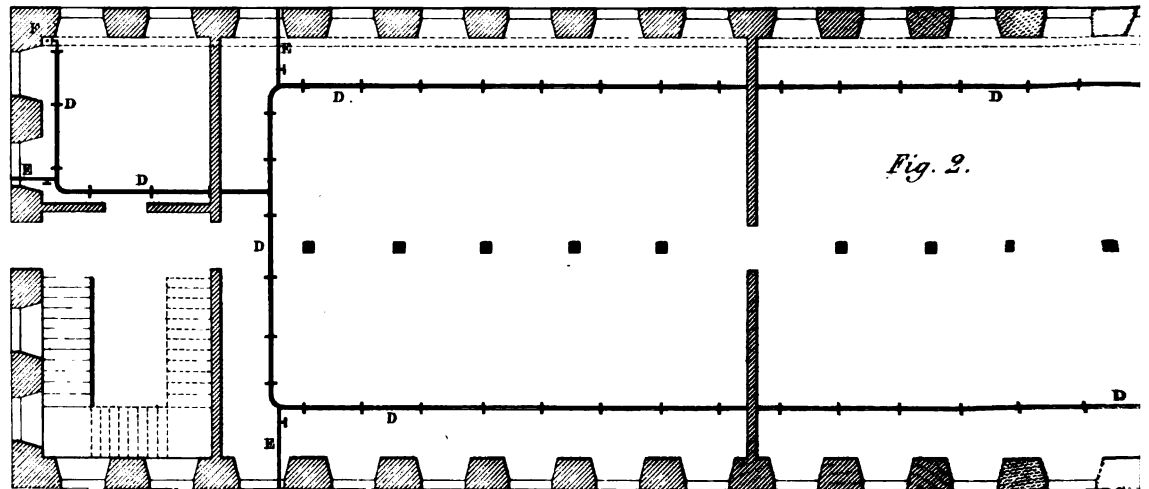
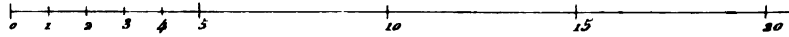


Fig. 3.

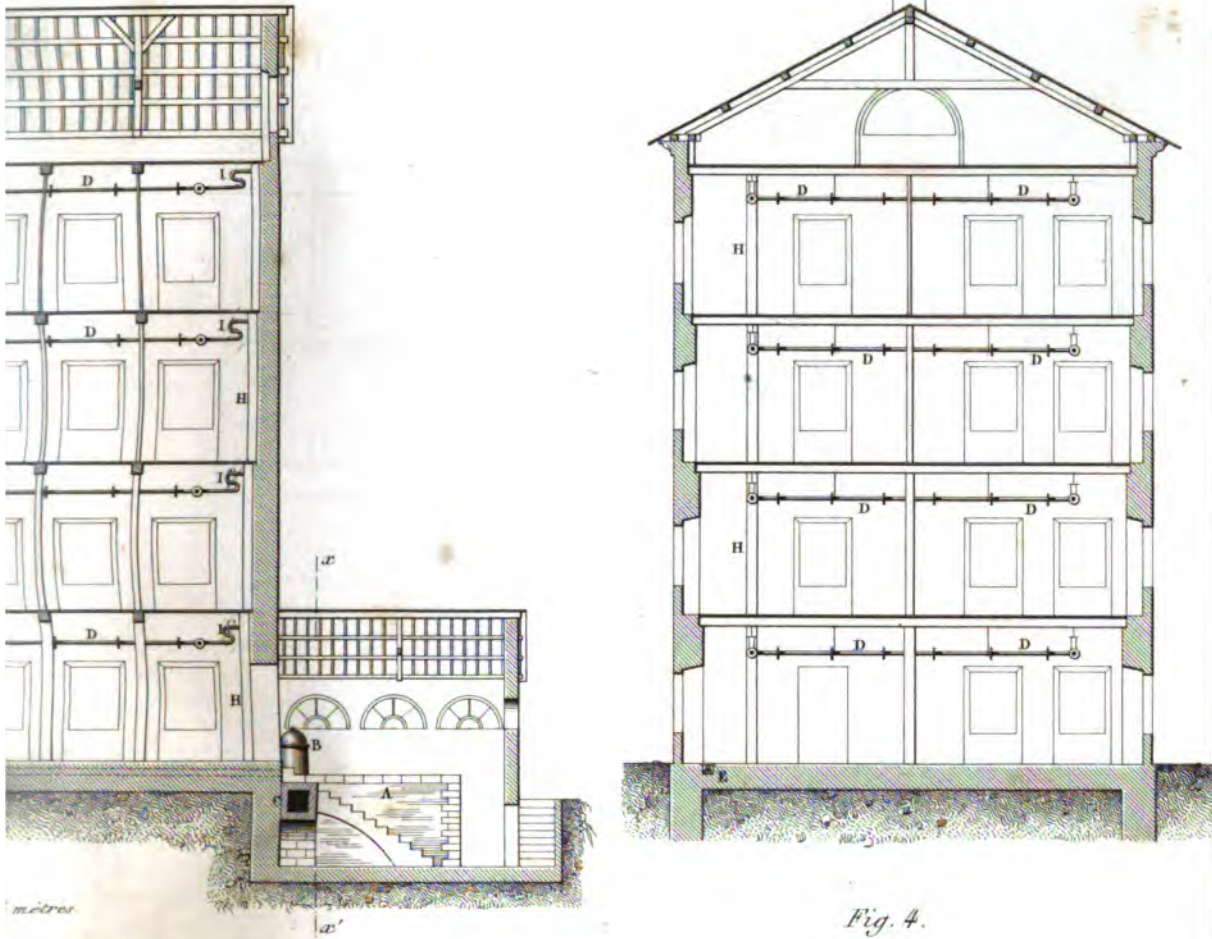
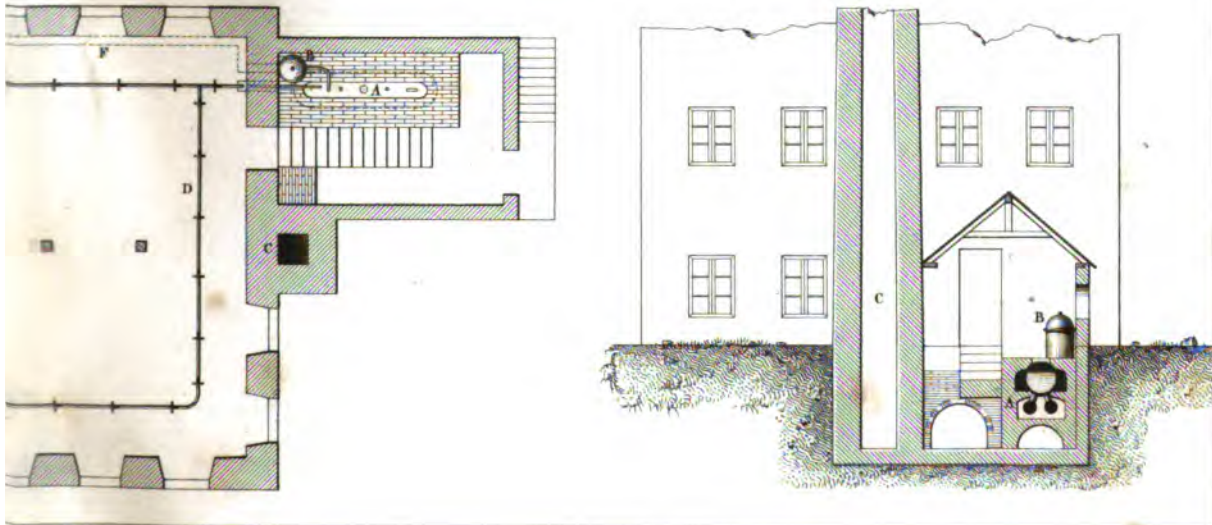
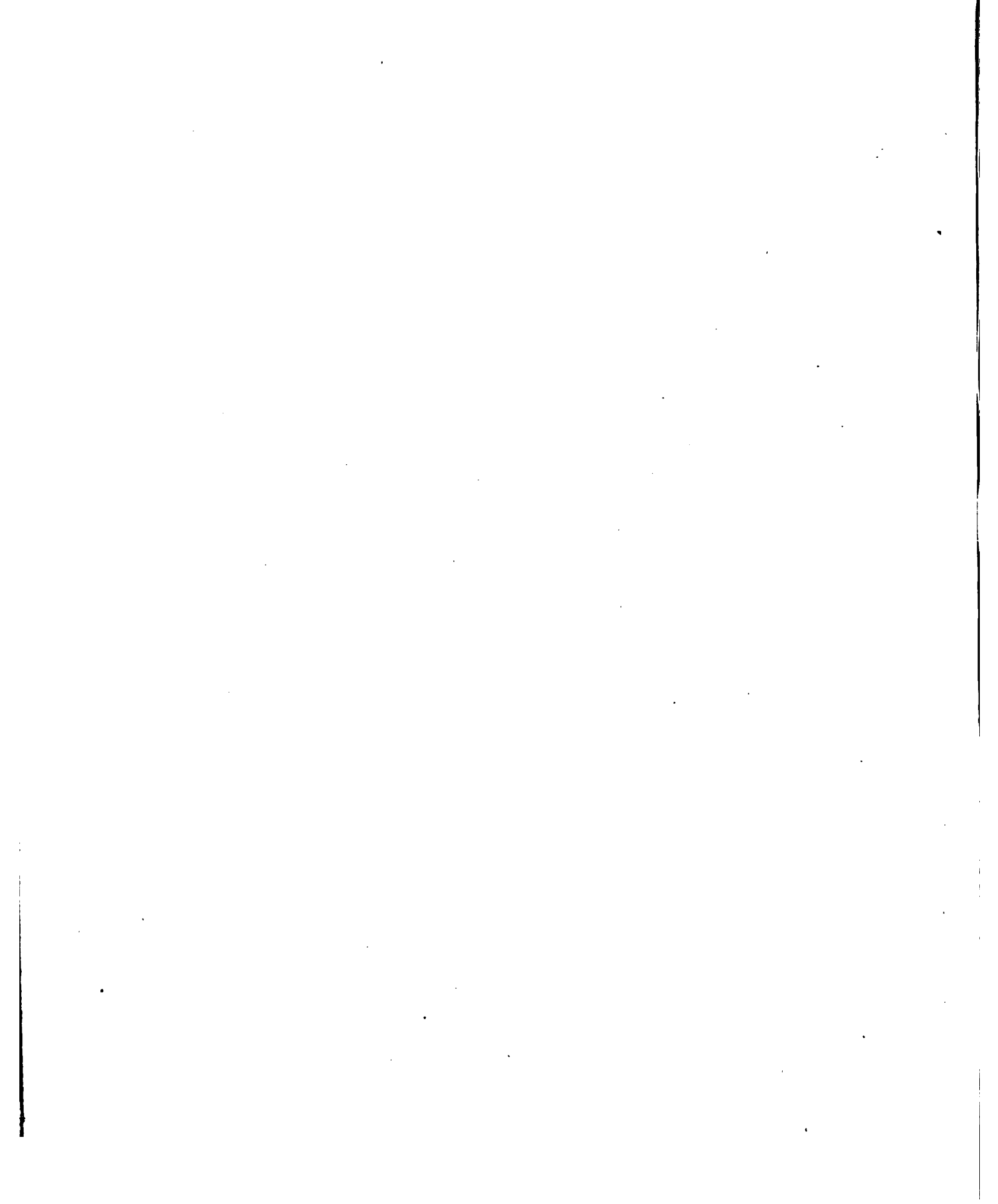


Fig. 4.







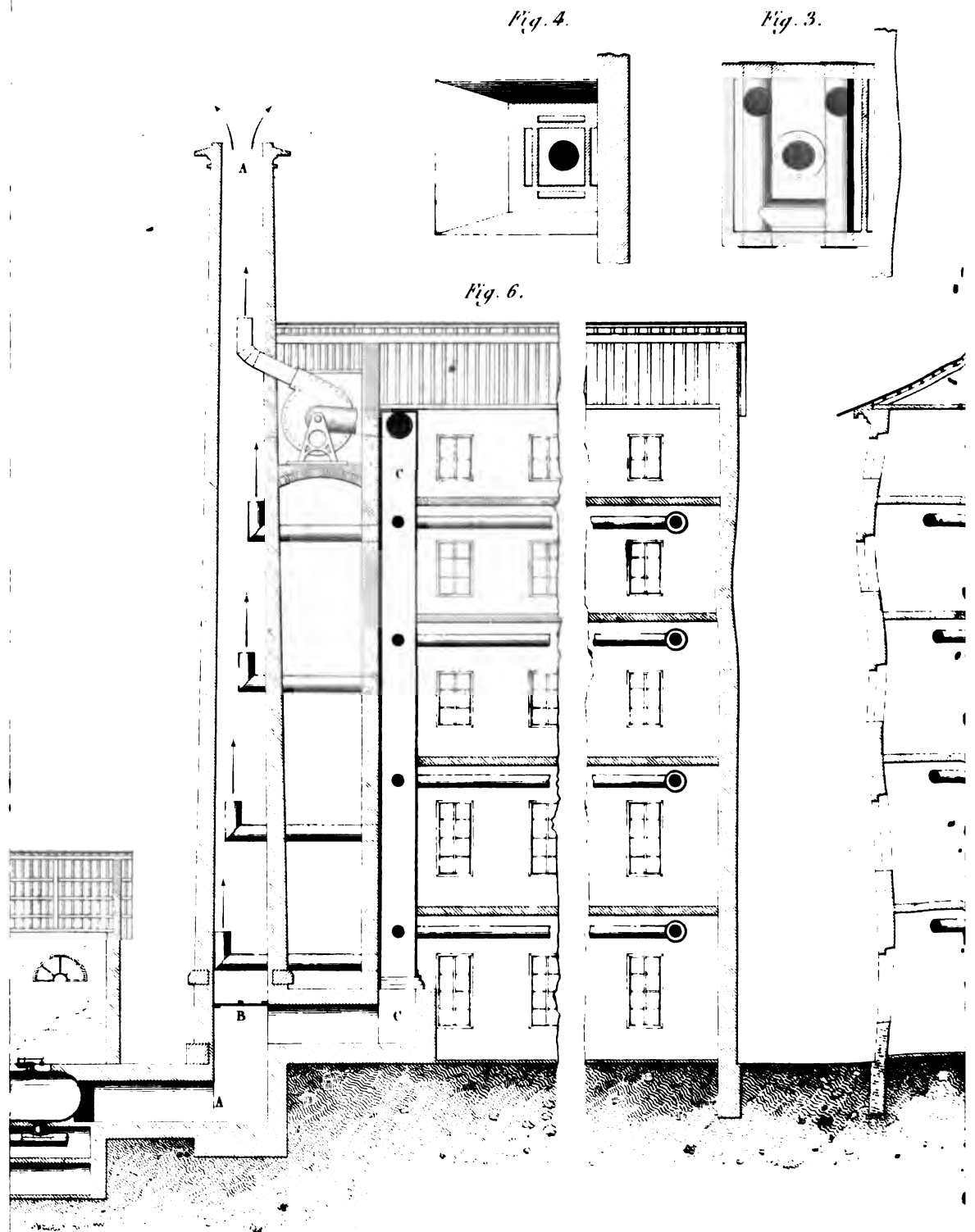


Fig. 2.

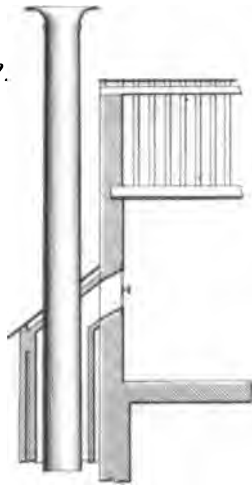


Fig. 1.

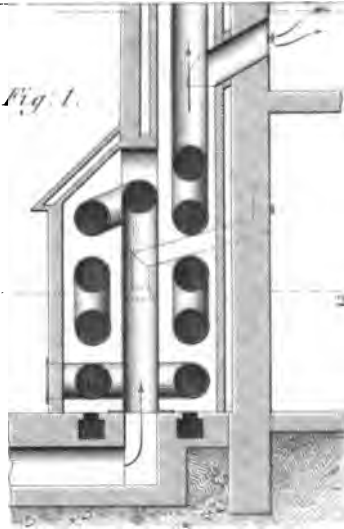


Fig. 7.

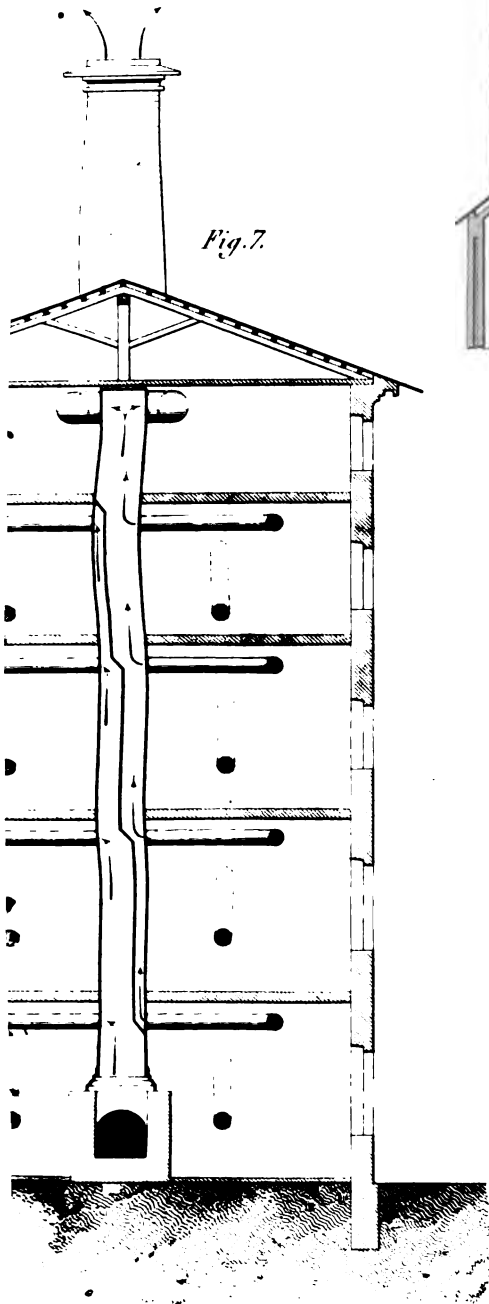


Fig. 5.

